

PASSION FOR PRECISION

English







The future of WIDIN is always bright.

WIDIN will share the same vision with customers by providing top quality products at competitive price, best service and pursue the core management doctrine of "Customer-based management".

With the WIDIN's rapid growth, its export is also increasing every year through steady improvement in technology, quality and great efforts for opening up a new market.

As WIDIN's mission, endless growth and development, WIDIN will make steady progress to the world.



Global Network



WIDIN will continuously expand its business with the whole world as our market.

Our export started in the late of 90's is growing fast by ceaseless activities to find a new market with our high quality products.



Argentina
Australia
Austria
Belgium
Brazil
Canada
China
Colombia
Czech
Denmark
Egypt
France
Germany
Greece
Hong Kong
Hungary
India
Indonesia
Iran
Italy
Japan
Malaysia
Mexico
Netherlands
New Zealand
Norway
Philippines
Poland
Portugal
Russia
Singapore
Slovenia
South Africa
Spain
Sweden
Switzerland
Thailand
Turkey
U.S.A
United Kingdom
Vietnam



Greeting

Making customer's dreams a reality- The best mechanical solution.

Since its establishment in 1988, WIDIN CO.,LTD. has been contributed to pursue the utmost customer satisfaction for the current and potential customers in the globalized market.

With continuously doing development and creativeness of the new technology through the great initiative, we, WIDIN CO.,LTD. is always ready to response of customer needs in customer mind and eye.

To cope with the enormous, various customer demands and satisfaction from popular products to high value added products in the cutting tools industry, WIDIN CO.,LTD. will put its best effort and will play a role of marketing initiator to lead the new 21st era by production and marketing linkage.

Aim to provide the best for money, fine tuned price, utmost quality, excellent customer services based on professionalism, all WIDIN CO.,LTD. will promise to do its best effort at time and where it is.

Thank you.

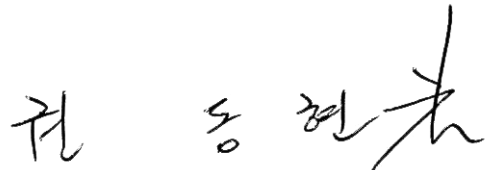













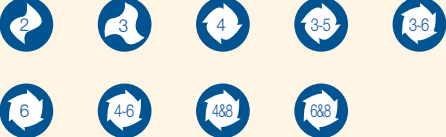
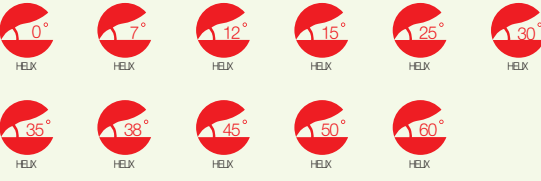





President and CEO Dong Hyun Kwon

History



- 1988. 07. Established Hana Cutting Tools Co.,Ltd.
- 1993. 05. Moved to new premises in Changwon City Korea
- 2000. 03. Opened the Seoul office at Guro Machine and Tool Complex Area
- 2001. 04. Appointed as the intensive supporting company for export by Gyeongnam Government
- 2001. 07. Certified in ISO9001 quality management system
- 2001. 12. Agreed with Machine Tools Technical Research Center in Changwon International University For Machine Tools Consortium
- 2002. 05. Registered the Utility Model No. 0277126
- 2002. 05. Registered the Utility Model No. 0350651
- 2004. 02. Introduced Automated Tool production Network System
- 2004. 11. Awarded a Bronze Medal of 34th Precision Technology Encouragement Award
- 2004. 11. Received a letter of recommendation by Ministry of Commerce & Energy Industry
- 2005. 02. Opened the Shanghai Office in the Gyeongnam Trade office, Shanghai China
- 2005. 02. Opened the Busan Office in Busan Industry and Tool Complex Area
- 2005. 08. Opened the Changwon Office in Changwon
- 2005. 10. Appointed as a professional manufacturing company in machine parts & materials by the Ministry of Commerce, Industry and Energy
- 2005. 11. Certified in INNO-BIZ(Innovative company)
- 2006. 11. Nominated for Excellent Quality Product Manufacturer by Korea chamber of commerce & industry on Nov. 29, 2006
- 2006. 11. Awarded one million dollar prize
- 2007. 02. HANA TOOLS CO., LTD. has acquired Patent 'Broken Index type End mill'
- 2007. 05. Awarded Presidential Prize
- 2007. 07. Changing name of company from HANA TOOLS CO.,LTD. to WIDIN CO.,LTD.
- 2008. 07. Observed the 20th anniversary of the foundation with opening new SungJu premises in Changwon city
- 2008. 11. Awarded three million dollar export prize
- 2010. 05. Awarded Global standard management awards
- 2011. 11. Awarded five Million Dollar export achievement prize from Government
- 2012. 01. Appointed as global hidden champions by Small & medium business Corporation
- 2012. 06. Moved to a larger facility located in Sahaw-ro, Changwon City
- 2015. 06. Prime Minister's Award
- 2016. 06. Awarded as 2016 strengthen export project Gazelle Firm

Guide Line to Icons

<h2>Raw-Material</h2>	<ul style="list-style-type: none">  Ultra fine grade is used in the tool <small>ULTRAFINE</small>  Micro grain grade is used in the tool <small>FINEGRAN</small>  K10~K20 grade is used in the tool
<h2>Number of Teeth</h2>	
<h2>Helix Angle</h2>	
<h2>Coating</h2>	<ul style="list-style-type: none">  ALTiN + HH  TiAlN + SH  CRN Coating  ALTiN + H  TiAlN + HH  Diamond Coating <small>DIAMOND</small>  ALTiN  TiAlN  D.L.C. Coating <small>DLC</small>
<h2>The Type of End Teeth</h2>	<ul style="list-style-type: none">  Ball Nose  Corner Radius  Chamfer
<h2>The Type of Periphery</h2>	<ul style="list-style-type: none">  Fine Pitch Type  Flat Shallow Pitch Type <small>Flat Shallow Pitch</small>  Chamfered Pitch Type  Coarse Pitch Type <small>Conventional Pitch</small>

Product Content

ENDMILL SERIES



10

DRILL SERIES



294

CENTERING TOOLS
& REAMERS



364

TAP SERIES



382

ENDMILL series



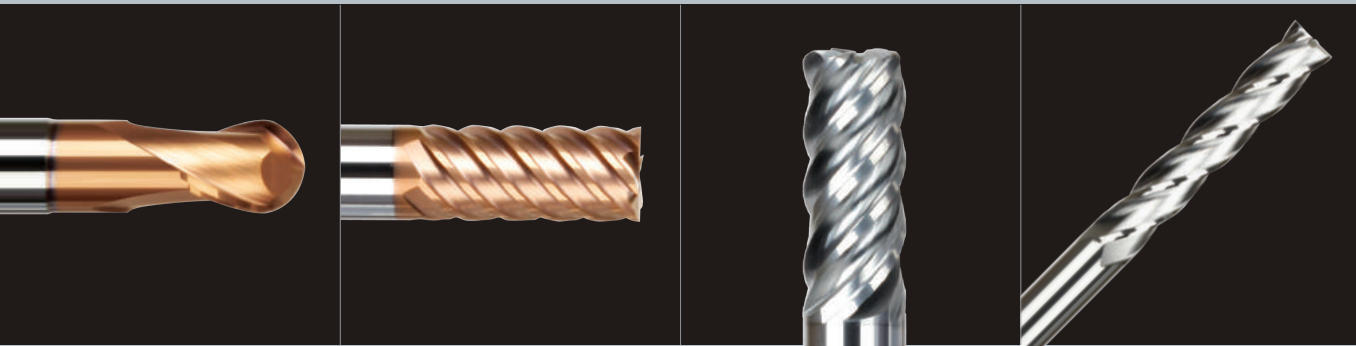

Zamus Star Series

High Speed Cutting & High Hardened Steel(from HRc 50 to HRc 70)

34

Neo Classic X-STAR Series

High performance & High efficiency (up to HRc45)

90

Zamus Classic Series

High Speed Cutting & High Hardened Steel(from HRc 30 to HRc 55)

114

Zamus Thunder Series

High Speed Cutting & High Hardened Steel(from HRc 25 to HRc 50)

180

Zamus Sus-Mate Series

Stainless Steel, Titanium, Inconel and Steels up to HRc 45

206

Zamus Copper-Mate Series

Copper, Copper Alloy and Non-ferrous Material

212

Zamus Gra-Mate Series

Graphite and Non-ferrous

216

Zamus Al-Mate Series

Aluminum and Non-ferrous

222

Standard End Mill Series

General Purpose

233

Technical Data

248

Z-STAR Broken index geometry series

- Reducing cycle time for high feed rates!
- Capable of bottom machining operations during flat bottom machining!



Test Report

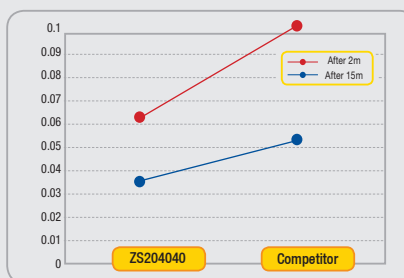

*Cutting Condition

- RPM : 12,000
- Feed : 710 mm/min
- Tool : ZS204040.
- Competitor : XX-XX 6F. Dia4.0
- Oil : Wet(Oil Mist)
- Workpiece : SKD11(HRC55)

Test Pictures

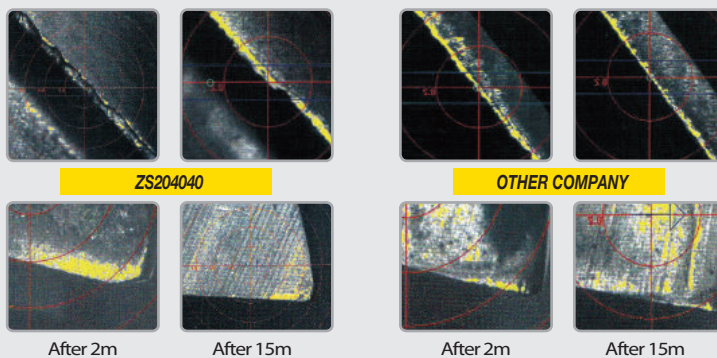

Workpiece surface

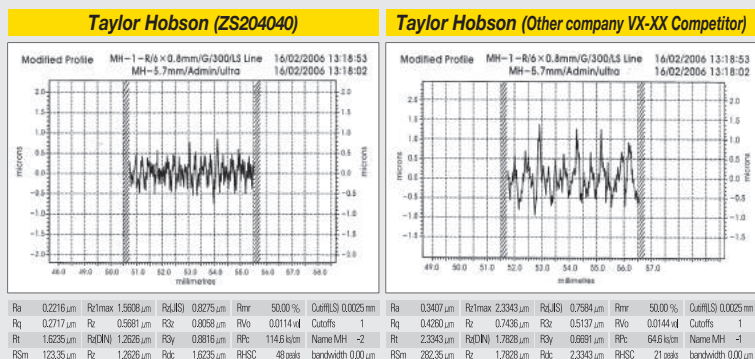

5 Flutes broken index geometry
XE / XR series

5 Flutes broken index geometry



- Dramatically increased tool life expectancy and durability due to newly developed raw-materials.
- High precision, excellent surface and maximum tool life because of newly developed coating.



5 Flutes Broken index geometry Product Feature

- High precision and excellent surface roughness due to each 5F broken index geometry
- The unique design decrease chatter and resonance, can achieve slotting operation

Summary of advantages

Suitable for semi - roughing and finishing
 Extremely high form accuracy
 Vibration - free operation
 Optimised flute geometry
 High feed rates possible
 Optimal surface quality
 Increased tool life

Workpiece surface

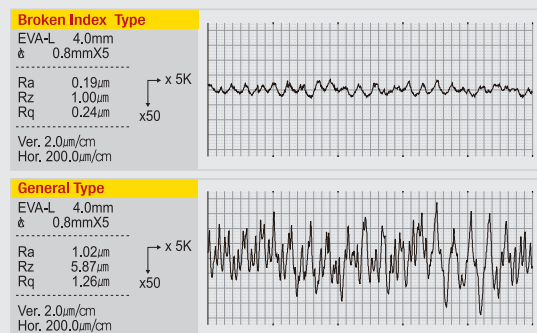

X-STAR

Variable index geometry series

- Reducing cycle time for high feed rates!
- Capable of bottom machining operations during flat bottom machining!



Variable index geometry Product Feature

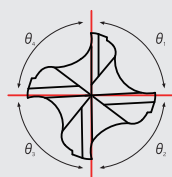

- High precision and excellent surface roughness due to each 4F variable index geometry
- The unique patented design decrease chatter and resonance, can achieve a Axial Depth 1XD slotting operation.

$$\theta_1 \neq \theta_2 \neq \theta_3 \neq \theta_4$$

Test Report



Cutting Condition

- RPM : 3,210
- Tool : XE504100(Ø10)
- Slotting : 1xD
(Ad : 10mm, Rd : 10mm)
- Workpiece : SUS304

Workpiece surface

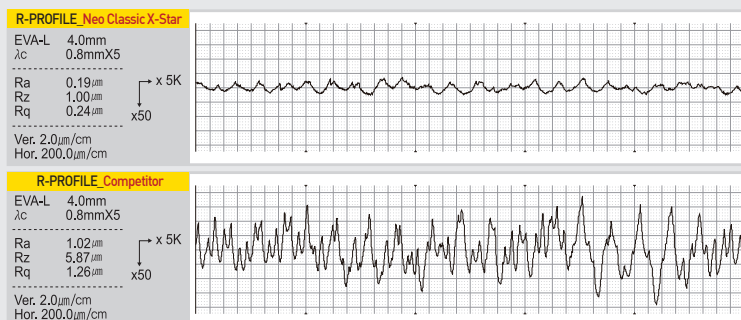

RIB PROCESSING

DB612 / ZE612 series

RIB PROCESSING



DB612 / ZE612 series

- Dramatically increased tool life expectancy and durability due to newly developed raw-materials.
- Economical and efficient compared to its price.
- High precision, excellent surface and maximum tool life because of newly developed coating.



2 Flute, for RIB Processing

- Designed for hardened steel, alloy steel, die steel and other high hardened materials.
- Long neck design for deep machining processes near walls.

DB612 ...series

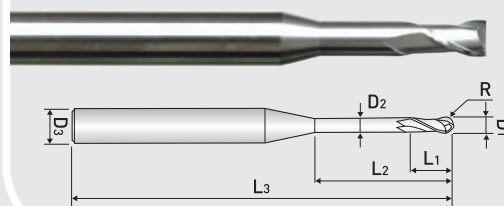

ZE612 ...series

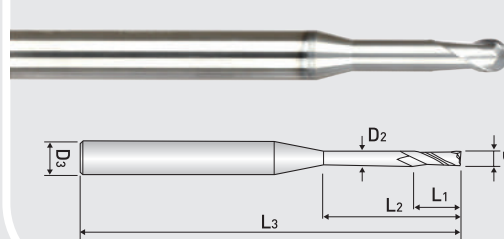

TAP SERIES



HSS and Carbide TAP series

- Straight Taps
- Spiral Taps
- Roll Taps
- Spiral Roll Taps
- Point Taps



Straight Tap, Spiral tap

Thread Size	Drill Size(mm)	mm	
		Min	Max
M3 X 0.5	2.50	2.459	2.599
M4 X 0.7	3.30	3.242	3.422
M5 X 0.8	4.20	4.134	4.334
M6 X 1.0	5.00	4.917	5.153
M8 X 1.25	6.80	6.647	6.912
M10 X 1.25	8.80	8.647	8.912
M10 X 1.5	8.50	8.376	8.676
M12 X 1.0	11.00	10.917	11.153
M12 X 1.25	10.80	10.647	10.912
M12 X 1.5	10.50	10.376	10.676
M12 X 1.75	10.30	10.106	10.441
M14 X 1.5	12.50	12.376	12.676
M14 X 2.0	12.00	11.835	12.21
M16 X 1.5	14.50	14.376	14.676
M16 X 2.0	14.00	13.835	14.21
M18 X 1.5	16.50	16.376	16.676
M18 X 2.5	15.50	15.294	15.744
M20 X 1.5	18.50	18.376	18.676
M20 X 2.5	17.50	17.294	17.744

Recommended Drill hole

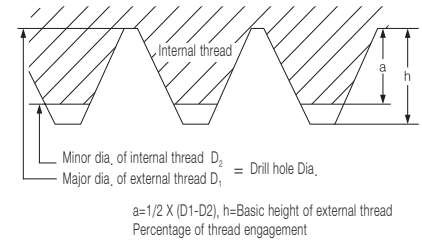

Figure, Percentage of thread engagement : When external thread profile is equal to basic profile.

$$\text{Percentage of thread engagement} = \frac{\text{Basic major dia. of external thread} - \text{Drill hole dia.}}{2 \times \text{Basic height of thread engagement}}$$

$$\text{Drill hole Dia.} = d - 2 \times H \times \frac{\text{Percentage of thread engagement}}{100}$$

d : Major Dia. of external thread
 H (Basic height of thread engagement) = $0.541266P$
 P : Pitch (mm)

* The recommended tap limit in compliance with JIS class 2 internal thread standard.

Roll tap

Thread Size	Drill Size(mm)	mm	
		Min	Max
M3 X 0.5	2.80	2.76	2.81
M4 X 0.7	3.70	3.65	3.7
M5 X 0.8	4.60	4.59	4.66
M6 X 1.0	5.50	5.48	5.57
M8 X 1.25	7.40	7.34	7.41
M10 X 1.25	9.40	9.34	9.41
M10 X 1.5	9.20	9.18	9.28
M12 X 1.0	11.50	11.48	11.57
M12 X 1.25	11.40	11.34	11.41
M12 X 1.5	11.20	11.18	11.28
M12 X 1.75	11.10	11.05	11.15

Recommended Drill hole

$$\text{DRILL diameter} = D - 0.0068 \times P \times 65$$

[D:Nominal Diameter
P: 65% of the length's screw thread]
65% of the length's screw thread

* The recommended tap limit is not included in JIS class standard and is just reference.

Corner rounding cutter CRC Series







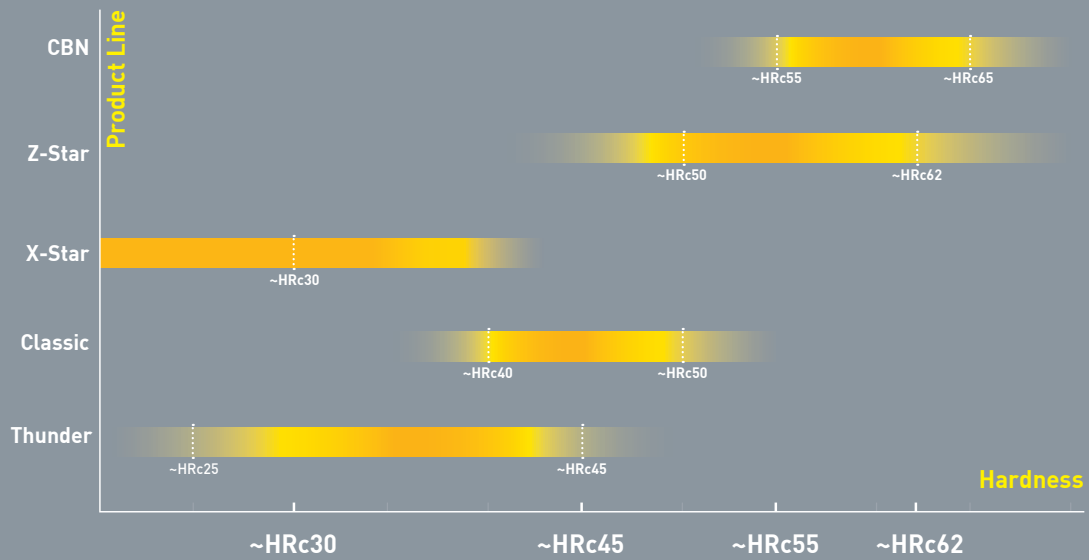



























- Designed for prehardened, hardened and stainless steels and cast iron up to HRc 52.
- By using the newly developed raw-material(0.2 um), it provides excellent performance during high speed cutting.



Cutting Tools Category Table



































ENDMILL SERIES METRIC SIZE

Class	Feature	Type	Appearance	No. of Teeth	Item	App.	EDP. No.	Page	
ZAMUS STAR	* Hardened Steels (~ HRC 70) * High Speed Cutting	SQUARE		2 FLUTE	LONG NECK	HSC	ZSLNS20	37	
				4 FLUTE	LONG NECK	HSC	ZSLNS40	42	
		BALL		2 FLUTE	LONG NECK	HSC	ZSLNB	44	
		RADIUS		2 FLUTE	LONG NECK & BACK DRAFT TYPE	HSC	ZSLNR	48	
				2 FLUTE	TAPER NECK & BACK DRAFT TYPE	HSC	ZSTNB20	52	
		BALL		2 FLUTE	TAPER NECK & BACK DRAFT TYPE	HSC	ZSTNB30	56	
				3 FLUTE	TAPER NECK & BACK DRAFT TYPE	HSC	ZSTNB30	56	
		RADIUS		2 FLUTE	TAPER NECK & BACK DRAFT TYPE	HSC	ZSTNR	57	
		SQUARE		4 FLUTE	LONG CUT LENGTH BROKEN INDEX	HSC	ZS124	59	
		SQUARE & RADIUS		4 FLUTE	CORNER RADIUS BROKEN INDEX	HSC	ZS1(2)04	60	
				4 FLUTE	CORNER RADIUS BROKEN INDEX	HSC	ZS204	61	
		* High speed & High feed rates	RADIUS		4 FLUTE	STUB CUT LENGTH, with EXTENDED NECK	HSC	ZSPM4	63
		* Hardened Steels (~ HRC 70) * High Speed Cutting	BALL		2 FLUTE	STUB CUT LENGTH, BALL NOSE with EXTENDED NECK	HSC	DB702	64
					2 FLUTE	REGULAR LENGTH, BALL NOSE	HSC	DB712	65
				3 FLUTE	BALL NOSE for FINISHING MOLD & DIE	HSC	DB703	66	
				4 FLUTE	TAPER NECK for FINISHING MOLD & DIE	HSC	DB734	67	
	RADIUS			2 FLUTE	STUB CUT LENGTH, with EXTENDED NECK	HSC	ZE702	68	
				4 FLUTE	STUB CUT LENGTH, with EXTENDED NECK	HSC	ZE704	69	
				4&6 FLUTE	FINISHING for MOLD & DIE	HSC	ZE724(6)	70	
				2 FLUTE	STUB CUT LENGTH, CORNER RADIUS with EXTENDED NECK	HSC	ZR702	71	
				2 FLUTE	CORNER RADIUS with LONG SHANK	HSC	ZR732	76	
				4 FLUTE	STUB CUT LENGTH, CORNER RADIUS with EXTENDED NECK	HSC	ZR704	78	
				4 FLUTE	45° HELIX FINISHING MOLD & DIE	HSC	ZR714	81	
				4 FLUTE	STUB CUT LENGTH, CORNER RADIUS with LONG SHANK	HSC	ZR724	82	
				4 FLUTE	CORNER RADIUS with LONG SHANK	HSC	ZR734	83	
				6 FLUTE	45° HELIX STUB CUT LENGTH, CORNER RADIUS with EXTENDED NECK	HSC	ZR706	85	
				6 FLUTE	45° HELIX, LONG SHANK, CORNER RADIUS	HSC	ZR736	86	
			SQUARE		2 FLUTE	35° HELIX REGULAR LENGTH	HSC	ZE712	87
				4 FLUTE	45° HELIX REGULAR LENGTH	HSC	ZE714	88	
	6 FLUTE			50° HELIX REGULAR LENGTH	HSC	ZE716	89		
NEO CLASSIC X-STAR	* High performance & High efficiency (~HRC45)		SQUARE		5 FLUTE	STUB CUT LENGTH		XE505A	93
					5 FLUTE	REGULAR CUT LENGTH		XE515A	94
		RADIUS		5 FLUTE	STUB CUT LENGTH CORNER RADIUS		XR505A	95	
				5 FLUTE	REGULAR CUT LENGTH CORNER RADIUS		XR515A	96	



































	Carbon Steels (S45C,S55C...) ~ HB225	Alloy Steels (SCM,SK...) HB225~325	Prehardened Steels(NAK...) HRC30~50	Hardened Steels		Copper	Graphite	Cast Iron FCD400, 500~	Aluminum	Stainless Steels
				~HRc55 SKD61	HRc55~ SKD11					
		○	○	◎	◎	○				
	◎	◎	○			○				◎

ENDMILL SERIES METRIC SIZE

Class	Feature	Type	Appearance	No. of Teeth	Item	App.	EDP. No.	Page
NEO CLASSIC X-STAR	* High performance & High efficiency (~HRc45)	SQUARE		5 FLUTE	REGULAR CUT LENGTH WITH EXTENDED NECK		XR525A	97
		CHAMFER		5 FLUTE	REGULAR CUT LENGTH WITH LONG EXTENDED NECK		XR535A	98
		SQUARE		5 FLUTE	REGULAR CUT LENGTH		XE505	99
				5 FLUTE	LONG CUT LENGTH		XE515	100
		RADIUS		5 FLUTE	REGULAR CUT LENGTH CORNER RADIUS		XR505	101
		BALL		4 FLUTE	REGULAR LENGTH, BALL NOSE		XXB504	102
		SQUARE		4 FLUTE	REGULAR LENGTH		XCE504	103
				4 FLUTE	REGULAR LENGTH		XCC504	104
				4 FLUTE	REGULAR LENGTH		XCR504	105
				3 FLUTE	REGULAR LENGTH		XCE503	106
				3 FLUTE	REGULAR LENGTH		XCC503	107
				3 FLUTE	REGULAR LENGTH		XCR503	108
		RADIUS		4 FLUTE	REGULAR LENGTH		XE504	109
				4 FLUTE	REGULAR LENGTH		XR504	110
		CHAMFER		4 FLUTE	STUB CUT LENGTH with EXTENDED NECK		XE514	111
				4 FLUTE	STUB CUT LENGTH with EXTENDED LONG NECK		XE524	112
RADIUS		4 FLUTE	REGULAR LENGTH		XR514	113		
ZAMUS CLASSIC	* Hardened Steels (~ HRc 55) * High Speed Cutting * General Speed Cutting	BALL		2 FLUTE	SHORT LENGTH, BALL NOSE	HSC	DB402	118
				2 FLUTE	15° HELIX STUB CUT LENGTH, BALL NOSE with EXTENDED NECK	HSC	DB412	119
				2 FLUTE	LONG LENGTH, BALL NOSE	HSC	DB512	120
				4 FLUTE	LONG LENGTH, BALL NOSE	HSC	DB514	121
				2 FLUTE	STUB CUT LENGTH, BALL NOSE with EXTENDED NECK	HSC	DB502	122
				2 FLUTE	EXTENDED NECK-LONG SHANK	HSC	DB522	123
				2 FLUTE	MMC-SPHERE TYPE	HSC	DB532	124
				4 FLUTE	MMC-SPHERE TYPE	HSC	DB534	125
		SQUARE		2 FLUTE	BALL NOSE with TAPER NECK	HSC	DB54(5)2	126
				2 FLUTE	REGULAR LENGTH	HSC	ZE502	127
				4 FLUTE	REGULAR LENGTH	HSC	ZE504	128
				3 FLUTE	REGULAR LENGTH	HSC	ZE503	129
				6 FLUTE	REGULAR & LONG LENGTH	HSC	ZE506	130
				2 FLUTE	MEDIUM LENGTH	HSC	ZM502	131
				4 FLUTE	MEDIUM LENGTH	HSC	ZM504	132
	2 FLUTE	MEDIUM CUT, LONG SHANK TYPE	HSC	ZM522	133			

	Carbon Steels (S45C,S55C...) ~ HB225	Alloy Steels (SCM,SK...) HB225~325	Prehardened Steels(NAK...) HRC30~50	Hardened Steels		Copper	Graphite	Cast Iron FCD400, 500~	Aluminum	Stainless Steels
				~HRc55 SKD61	HRc55~ SKD11					
	◎	◎	○			○				◎
	○	○	◎	○				○		○

































ENDMILL SERIES METRIC SIZE

Class	Feature	Type	Appearance	No. of Teeth	Item	App.	EDP. No.	Page
ZAMUS CLASSIC	* Hardened Steels (~ HRC 55) * High Speed Cutting * General Speed Cutting	SQUARE		4 FLUTE	MEDIUM CUT, LONG SHANK TYPE	HSC	ZM524	134
				2 FLUTE	LONG LENGTH	HSC	ZE522	135
				4 FLUTE	LONG LENGTH	HSC	ZE524	136
				4 FLUTE	EXTRA LONG LENGTH		ZE534	137
				2 FLUTE	35° HELIX REGULAR LENGTH	HSC	ZE512	138
				4 FLUTE	45° HELIX REGULAR LENGTH	HSC	ZE514	139
				6 FLUTE	50° HELIX REGULAR LENGTH	HSC	ZE516	140
		LONG NECK SQUARE		2 FLUTE	for RIB PROCESSING	HSC	ZE612	141
		LONG NECK BALL		2 FLUTE	for RIB PROCESSING	HSC	DB612	145
		RADIUS		2 FLUTE	STUB CUT LENGTH, CORNER RADIUS with EXTENDED NECK		ZR502	149
				4 FLUTE	STUB CUT LENGTH, CORNER RADIUS with EXTENDED NECK		ZR504	150
				2 FLUTE	REGULAR LENGTH, CORNER RADIUS		ZR512	151
				4 FLUTE	REGULAR LENGTH, CORNER RADIUS		ZR514	152
				2 FLUTE	LONG LENGTH, CORNER RADIUS		ZR522	153
				4 FLUTE	LONG LENGTH, CORNER RADIUS		ZR524	154
		BALL		MULTIPLE	TAPER BALL, RIB PROCESSING	HSC	TPRB4-050	155
				MULTIPLE	TAPER BALL, RIB PROCESSING	HSC	TPRB4-075	156
				MULTIPLE	TAPER BALL, RIB PROCESSING	HSC	TPRB4-100	157
				MULTIPLE	TAPER BALL, RIB PROCESSING	HSC	TPRB4-150	159
				MULTIPLE	TAPER BALL, RIB PROCESSING	HSC	TPRB4-200	161
		SQUARE		MULTIPLE	TAPER, RIB PROCESSING	HSC	TPRE4-050	163
				MULTIPLE	TAPER, RIB PROCESSING	HSC	TPRE4-075	165
				MULTIPLE	TAPER, RIB PROCESSING	HSC	TPRE4-100	167
				MULTIPLE	TAPER, RIB PROCESSING	HSC	TPRE4-150	169
				MULTIPLE	TAPER, RIB PROCESSING	HSC	TPRE4-200	171
				MULTIPLE	TAPER, RIB PROCESSING	HSC	TPRE4-300	173
		TAPER		3 FLUTE	TAPER END MILL		TE503	174
		TAPER BALL		3 FLUTE	TAPER BALL END MILL		TB503	175
				4 FLUTE	TAPER BALL END MILL		TB504	176
		ROUGHING		3-6 FLUTE	ROUGHING END MILL		ZF60	177
				3-5 FLUTE	ROUGHING END MILL - FINE PITCH		ZF61	178
				3 FLUTE	Z - AXIS ROUGHING END MILL		PK503	179























Carbon Steels (S45C,S55C...) ~ HB225	Alloy Steels (SCM,SK...) HB225~325	Prehardened Steels(NAK...) HRC30~50	Hardened Steels		Copper	Graphite	Cast Iron FCD400, 500~	Aluminum	Stainless Steels
			~HRc55 SKD61	HRc55~ SKD11					
○	○	◎	○				○		○

ENDMILL SERIES METRIC SIZE

Class	Feature	Type	Appearance	No. of Teeth	Item	App.	EDP. No.	Page
ZAMUS THUNDER	* Hardened Steels (~ HRC 45) * High Speed Cutting * General Speed Cutting	BALL		2 FLUTE	LONG LENGTH, BALL NOSE		DB312	183
				2 FLUTE	BALL NOSE with TAPER NECK		DB342	184
		SQUARE		2 FLUTE	REGULAR LENGTH		ZE302	185
				4 FLUTE	REGULAR LENGTH		ZE304	186
				2 FLUTE	LONG LENGTH		ZE322	187
				4 FLUTE	LONG LENGTH		ZE324	188
		RADIUS		2 FLUTE	CORNER RADIUS LONG LENGTH		ZR322	189
				4 FLUTE	CORNER RADIUS LONG LENGTH		ZR324	190
				4 FLUTE	45° HELIX STUB CUT LENGTH, CORNER RADIUS, EXTENDED NECK		ZR304H	191
				4 FLUTE	45° HELIX STUB CUT LENGTH, CORNER RADIUS, LONG SHANK		ZR324H	192
	* Hardened Steels (~ HRC 45) * High Speed Cutting * General Speed Cutting * Economic Type	SQUARE		2 FLUTE	REGULAR LENGTH		TX302	193
				4 FLUTE	REGULAR LENGTH		TX304	194
				4 FLUTE	45° HELIX, REGULAR LENGTH		TX304H	195
		BALL		2 FLUTE	REGULAR LENGTH, BALL NOSE		TXB302	196
				4 FLUTE	REGULAR LENGTH, BALL NOSE		TXB304	197
		SQUARE		2 FLUTE	SHORT LENGTH		TX202	198
	* Hardened Steels (~ HRC 45) * High Speed Cutting * General Speed Cutting * Economic Type	SQUARE		2 FLUTE	LONG LENGTH		TX222	199
				4 FLUTE	SHORT LENGTH		TX204	200
				4 FLUTE	LONG LENGTH		TX224	201
		BALL		2 FLUTE	REGULAR LENGTH, BALL NOSE		TXB202	202
			2 FLUTE	LONG LENGTH, BALL NOSE		TXB222	203	
			2 FLUTE	LONG REACH, BALL NOSE		TXB232	204	
			4 FLUTE	REGULAR LENGTH, BALL NOSE		TXB204	205	
			4 FLUTE	REGULAR LENGTH, BALL NOSE		TXB204	205	
ZAMUS SUS MATE	* Stainless Steels * Titanium * Inconell	BALL		2 FLUTE	BALL NOSE REGULAR & LONG LENGTH		DS502	208
		SQUARE		3 FLUTE	REGULAR LENGTH		SM503	209
			4 FLUTE	REGULAR LENGTH		SM504	210	
	ROUGHING		4~6 FLUTE	ROUGHING END MILL		ZF62	211	
ZAMUS COPPER-MATE	* Copper & non-ferrous material	BALL		2 FLUTE	STUB CUT with EXTENDED NECK		BC502	214
		RADIUS		2 FLUTE	STUB CUT with EXTENDED NECK		RC502	215
ZAMUS GRA-MATE	* Graphite & non-ferrous material	BALL		2 FLUTE	DIAMOND COATING BALL NOSE		G	218
		SQUARE		2 FLUTE	DIAMOND COATING END MILL		GE	221

	Carbon Steels (S45C,S55C...) ~ HB225	Alloy Steels (SCM,SK...) HB225~325	Prehardened Steels(NAK...) HRC30~50	Hardened Steels		Copper	Graphite	Cast Iron FCD400, 500~	Aluminum	Stainless Steels
				~HRc55 SKD61	HRc55~ SKD11					
	◎	◎	○							
	○	○	○			○				◎
	○	○				◎			○	
							◎		○	

ENDMILL SERIES METRIC SIZE

Class	Feature	Type	Appearance	No. of Teeth	Item	App.	EDP. No.	Page
ZAMUS AL-MATE	* Aluminum & non-ferrous material	SQUARE		2 FLUTE	LONG LENGTH - for Aluminum		AE302	224
				3 FLUTE	LONG & EXTRA LONG LENGTH		AE30(2)3	225
		BALL		2 FLUTE	CORNER RADIUS		AR302	227
				3 FLUTE	CORNER RADIUS		AR303	228
		RADIUS		2 FLUTE	STUB CUT BALL NOSE		AB312	229
				2 FLUTE	CORNER RADIUS with D.L.C. COATED		AR502	230
		ROUGHING		3 FLUTE	CORNER RADIUS with D.L.C. COATED		AR503	231
				3 FLUTE	ROUGHING END MILL - for Aluminum		AF303	232
STANDARD END MILL	* General & Multi-purpose	SQUARE		2 FLUTE	REGULAR LENGTH		E302	235
				4 FLUTE	REGULAR LENGTH		E304	237
		BALL		2 FLUTE	BALL NOSE LONG LENGTH		B302	238
				2 FLUTE	BALL NOSE EXTRA LONG LENGTH		BL422	239
				4 FLUTE	BALL NOSE LONG LENGTH		B304	240
		SQUARE		2 FLUTE	LONG LENGTH		E322	241
				4 FLUTE	LONG LENGTH		E324	242
				2 FLUTE	REGULAR LENGTH - BRAZED TYPE		EB302	243
				4 FLUTE	REGULAR LENGTH - BRAZED TYPE		EB304	244
				2 FLUTE	LONG LENGTH - BRAZED TYPE		EB322	245
				4 FLUTE	LONG LENGTH - BRAZED TYPE		EB324	246
		BALL		2 FLUTE	BALL NOSE REGULAR LENGTH - BRAZED TYPE		BB302	247





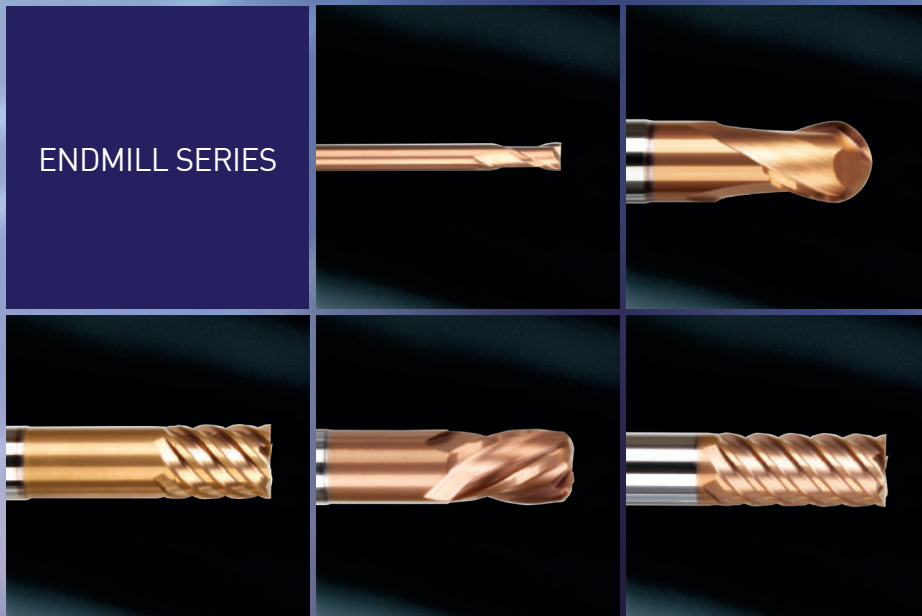









	Carbon Steels (S45C,S55C...) ~ HB225	Alloy Steels (SCM,SK...) HB225~325	Prehardened Steels(NAK...) HRC30~50	Hardened Steels		Copper	Graphite	Cast Iron FCD400, 500~	Aluminum	Stainless Steels
				~HRc55 SKD61	HRc55~ SKD11					
						○			◎	
	○	○								

Zamus Star Series



Zamus Star Series

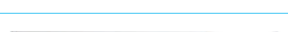

EDP. No.	APPEARANCE	FEATURE	STOCK	PAGE
ZSLNS20..... series		2 FLUTE, LONG NECK	•	37
ZSLNS40..... series		4 FLUTE, LONG NECK	•	42
ZSLNB..... series		2 FLUTE, LONG NECK	•	44
ZSLNR..... series		2 FLUTE, LONG NECK & BACK DRAFT TYPE	•	48
ZSTNB20..... series		2 FLUTE, TAPER NECK & BACK DRAFT TYPE		52
ZSTNB30..... series		3 FLUTE, TAPER NECK & BACK DRAFT TYPE		56
ZSTNR..... series		2 FLUTE, TAPER NECK & BACK DRAFT TYPE		57
ZS124 ...series		4 FLUTE, LONG CUT LENGTH BROKEN INDEX	•	59
ZS1(2)04 ...series		4 FLUTE, CORNER RADIUS BROKEN INDEX	•	60
ZS204series		4 FLUTE, CORNER RADIUS BROKEN INDEX	•	61
ZSPM4..... series		4 FLUTE, STUB CUT LENGTH, with EXTENDED NECK	•	63
DB702 ...series		2 FLUTE, STUB CUT LENGTH, BALL NOSE with EXTENDED NECK	•	64
DB712 ...series		2 FLUTE, REGULAR LENGTH, BALL NOSE	•	65
DB703 ...series		3 FLUTE, BALL NOSE for FINISHING MOLD & DIE	•	66
DB734 ...series		4 FLUTE, TAPER NECK for FINISHING MOLD & DIE	•	67

Zamus Star Series



EDP. No.	APPEARANCE	FEATURE	STOCK	PAGE
ZE702 ...series		2 FLUTE, STUB CUT LENGTH, with EXTENDED NECK	•	68
ZE704 ...series		4 FLUTE, STUB CUT LENGTH, with EXTENDED NECK	•	69
ZE724(6) ...series		4 & 6 FLUTE, FINISHING for MOLD & DIE	•	70
ZR702series		2 FLUTE, STUB CUT LENGTH, CORNER RADIUS with EXTENDED NECK	•	71
ZR732series		2 FLUTE, CORNER RADIUS with LONG SHANK	•	76
ZR704series		4 FLUTE, STUB CUT LENGTH, CORNER RADIUS with EXTENDED NECK	•	78
ZR714.....series		4 FLUTE, 45° HELIX FINISHING MOLD & DIE	•	81
ZR724series		4 FLUTE, STUB CUT LENGTH, CORNER RADIUS with LONG SHANK	•	82
ZR734series		4 FLUTE, CORNER RADIUS with LONG SHANK	•	83
ZR706series		6 FLUTE, 45° HELIX STUB CUT LENGTH, CORNER RADIUS with EXTENDED NECK	•	85
ZR736series		6 FLUTE, 45° HELIX, LONG SHANK, CORNER RADIUS	•	86
ZE712 ...series		2 FLUTE, 35° HELIX REGULAR LENGTH	•	87
ZE714 ...series		4 FLUTE, 45° HELIX REGULAR LENGTH	•	88
ZE716 ...series		6 FLUTE, 50° HELIX REGULAR LENGTH	•	89

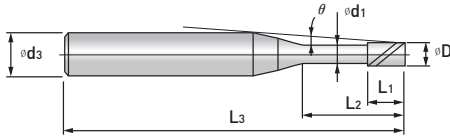

The effective neck length shown is not an exact value and to avoid contact with the workpiece, we recommend the user control the precise value of this length.

ZSLNS20....-.. series



EDP. No.	Dimension(mm)						Effective Neck Length					STOCK		
	D	L ₂	L ₁	d ₁	L ₃	d ₃	θ	0.5°	1°	1.5°	2°		3°	
ZSLNS2001-0.3	0.1	0.3	0.15	0.08	45	4	11.6	0.4	0.4	0.5	0.5	0.5	•	
ZSLNS2001-0.5		0.5						0.6	0.7	0.7	0.7	0.8	•	
ZSLNS2001-1		1						1.2	1.2	1.2	1.3	1.4	•	
ZSLNS2002-0.5	0.2	0.5	0.3	0.17	50	4	11.3	1.2	1.3	1.5	1.7	2.0	•	
ZSLNS2002-1		1						1.7	1.9	2.2	2.4	2.7	•	
ZSLNS2002-1.5		1.5						2.3	2.5	2.8	3.0	3.4	•	
ZSLNS2003-1	0.3	1	0.45	0.27	50	4	10.8	1.7	1.9	2.2	2.4	2.7	•	
ZSLNS2003-1.5		1.5						2.3	2.5	2.8	3.0	3.4	•	
ZSLNS2003-2		2						2.8	3.1	3.4	3.6	4.1	•	
ZSLNS2003-2.5		2.5						3.4	3.7	4.0	4.3	4.7	•	
ZSLNS2003-3		3						3.9	4.3	4.6	4.9	5.4	•	
ZSLNS2004-1	0.4	1	0.6	0.37	50	4	10.7	1.7	1.9	2.2	2.4	2.7	•	
ZSLNS2004-1.5		1.5						2.3	2.5	2.8	3.0	3.4	•	
ZSLNS2004-2		2						2.8	3.1	3.4	3.6	4.1	•	
ZSLNS2004-2.5		2.5						3.4	3.7	4.0	4.3	4.7	•	
ZSLNS2004-3		3						3.9	4.3	4.6	4.9	5.4	•	
ZSLNS2004-3.5		3.5						4.5	4.9	5.2	5.5	6.0	•	
ZSLNS2004-4		4						5.0	5.4	5.8	6.1	6.6	•	
ZSLNS2004-5		5						6.1	6.6	6.9	7.3	7.8	•	
ZSLNS2004-6	6	7.1	7.2	7.7	8.1	8.4	9.0	•						
ZSLNS2005-1	0.5	1	0.75	0.47	50	4	10.7	1.7	1.9	2.2	2.4	2.7	•	
ZSLNS2005-1.5		1.5						2.3	2.5	2.8	3.0	3.4	•	
ZSLNS2005-2		2						2.8	3.1	3.4	3.6	4.1	•	
ZSLNS2005-2.5		2.5						3.4	3.7	4.0	4.3	4.7	•	
ZSLNS2005-3		3						3.9	4.3	4.6	4.9	5.4	•	
ZSLNS2005-4		4						5.0	5.4	5.8	6.1	6.6	•	
ZSLNS2005-5		5						6.1	6.6	6.9	7.3	7.8	•	
ZSLNS2005-6		6						7.0	7.2	7.7	8.1	8.4	9.0	•
ZSLNS2005-8		8						9.3	9.9	10.3	10.7	11.4	•	
ZSLNS2006-2		0.6						2	0.9	0.57	50	4	9.6	2.8
ZSLNS2006-4	4		5.0	5.4	5.8	6.1	6.6	•						
ZSLNS2006-6	6		6.9	7.2	7.7	8.1	8.4	9.0						•
ZSLNS2006-8	8		9.3	9.9	10.3	10.7	11.4	•						
ZSLNS2006-10	10		11.5	12.1	12.6	13.0	13.7	•						

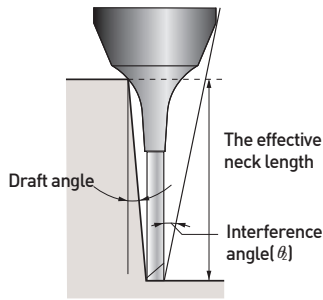

2 FLUTE, LONG NECK

- If the workpiece has draft angle, the interference length will be longer than the L_2 .
- Please refer to the effective neck length for the various draft angles.
- In addition, the angle at which the tool will interfere with the workpiece is shown as the "interference angle θ ", and should also be referred to.

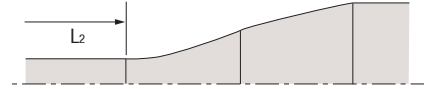

※The effective neck length shown is not an exact value and to avoid contact with the workpiece, we recommend the user control the precise value of this length.

EDP. No.	Dimension(mm)							Effective Neck Length					STOCK
	D	L ₂	L ₁	d ₁	L ₃	d ₃	θ	0.5°	1°	1.5°	2°	3°	
ZSLNS2007-2	0.7	2	1.05	0.67	50	4	9.6	2.8	3.1	3.4	3.6	4.1	•
ZSLNS2007-4		4					8.0	5.0	5.4	5.8	6.1	6.6	•
ZSLNS2007-6		6					6.9	7.2	7.7	8.1	8.4	9.0	•
ZSLNS2007-8		8					6.0	9.3	9.9	10.3	10.7	11.4	•
ZSLNS2007-10		10					5.3	11.5	12.1	12.6	13.0	13.7	•
ZSLNS2008-4	0.8	4	1.2	0.77	50	4	7.9	5.0	5.4	5.8	6.1	6.6	•
ZSLNS2008-6		6					6.8	7.2	7.7	8.1	8.4	9.0	•
ZSLNS2008-8		8					5.9	9.3	9.9	10.3	10.7	11.4	•
ZSLNS2008-10		10					5.2	11.5	12.1	12.6	13.0	13.7	•
ZSLNS2008-12		12			4.7	13.6	14.2	14.8	15.2	16.0	•		
ZSLNS2009-6	0.9	6	1.35	0.86	50	4	6.7	7.2	7.7	8.1	8.4	9.1	•
ZSLNS2009-8		8					5.8	9.4	9.9	10.4	10.7	11.4	•
ZSLNS2009-10		10					5.1	11.5	12.1	12.6	13.0	13.7	•
ZSLNS2009-12		12			4.6	13.6	14.3	14.8	15.2	16.0	•		
ZSLNS2010-2	1	2	1.5	0.96	50	4	9.4	2.9	3.2	3.4	3.7	4.1	•
ZSLNS2010-4		4					7.7	5.1	5.5	5.8	6.1	6.6	•
ZSLNS2010-6		6					6.6	7.2	7.7	8.1	8.4	9.1	•
ZSLNS2010-8		8					5.7	9.4	9.9	10.4	10.7	11.4	•
ZSLNS2010-10		10					5.0	11.5	12.1	12.6	13.0	13.7	•
ZSLNS2010-12		12			4.5	13.6	14.3	14.8	15.2	16.0	•		
ZSLNS2010-14		14			4.1	15.7	16.4	17.0	17.4	18.7	•		
ZSLNS2010-16		16			3.8	17.8	18.6	19.1	19.6	21.3	•		
ZSLNS2010-20		20			3.2	22.0	22.8	23.5	24.0	26.6	•		
ZSLNS2012-6	1.2	6	1.8	1.15	50	4	6.3	7.3	7.7	8.1	8.5	9.1	•
ZSLNS2012-8		8					5.5	9.4	9.9	10.4	10.8	11.4	•
ZSLNS2012-10		10					4.8	11.5	12.1	12.6	13.0	13.7	•
ZSLNS2012-12		12					4.3	13.6	14.3	14.8	15.2	16.0	•
ZSLNS2012-16		16			3.6	17.8	18.6	19.2	19.7	21.3	•		
ZSLNS2014-6	1.4	6	2.1	1.34	50	4	6.1	7.3	7.8	8.1	8.5	9.1	•
ZSLNS2014-8		8					5.3	9.4	10.0	10.4	10.8	11.5	•
ZSLNS2014-10		10					4.6	11.6	12.1	12.6	13.0	13.8	•
ZSLNS2014-12		12			4.1	13.7	14.3	14.8	15.3	16.1	•		
ZSLNS2014-14		14			3.7	15.8	16.5	17.0	17.5	18.7	•		
ZSLNS2014-16		16			3.4	17.9	18.6	19.2	19.7	21.4	•		

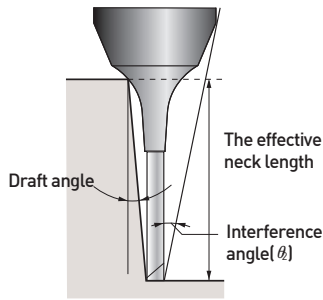

2 FLUTE, LONG NECK

- If the workpiece has draft angle, the interference length will be longer than the L_2 .
- Please refer to the effective neck length for the various draft angles.
- In addition, the angle at which the tool will interfere with the workpiece is shown as the "interference angle θ ", and should also be referred to.

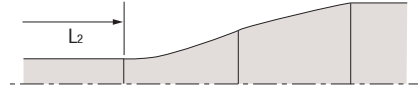

※The effective neck length shown is not an exact value and to avoid contact with the workpiece, we recommend the user control the precise value of this length.

EDP. No.	Dimension(mm)						Effective Neck Length					STOCK	
	D	L ₂	L ₁	d ₁	L ₃	d ₃	θ	0.5°	1°	1.5°	2°		3°
ZSLNS2015-4	1.5	4	2.25	1.44	50	4	7.2	5.2	5.5	5.9	6.2	6.7	•
ZSLNS2015-6		6					6.0	7.3	7.8	8.1	8.5	9.1	•
ZSLNS2015-8		8					5.1	9.4	10.0	10.4	10.8	11.5	•
ZSLNS2015-10		10					4.5	11.6	12.1	12.6	13.0	13.8	•
ZSLNS2015-12		12					4.0	13.7	14.3	14.8	15.3	16.1	•
ZSLNS2015-14		14			3.6		15.8	16.5	17.0	17.5	18.7	•	
ZSLNS2015-16		16			3.3		17.9	18.6	19.2	19.7	-	•	
ZSLNS2015-18		18			3.0		20.0	20.7	21.3	21.9	-	•	
ZSLNS2015-20		20			2.8		22.0	22.9	23.5	24.1	-	•	
ZSLNS2015-25		25			2.4		27.3	28.1	28.8	30.0	-	•	
ZSLNS2016-6	1.6	6	2.4	1.54	50	4	5.9	7.3	7.8	8.1	8.5	9.1	•
ZSLNS2016-8		8					5.0	9.4	10.0	10.4	10.8	11.5	•
ZSLNS2016-10		10					4.4	11.6	12.1	12.6	13.0	13.8	•
ZSLNS2016-12		12					3.9	13.7	14.3	14.8	15.3	16.1	•
ZSLNS2016-14		14			3.5		15.8	16.5	17.0	17.5	18.7	•	
ZSLNS2016-16		16			3.2		17.9	18.6	19.2	19.7	21.4	•	
ZSLNS2016-18		18			2.9		20.0	20.7	21.3	21.9	-	•	
ZSLNS2016-20		20			2.7		22.0	22.9	23.5	24.1	-	•	
ZSLNS2018-6	1.8	6	2.7	1.73	50	4	5.6	7.4	7.8	8.2	8.5	9.1	•
ZSLNS2018-8		8					4.8	9.5	10.0	10.4	10.8	11.5	•
ZSLNS2018-10		10					4.2	11.6	12.2	12.6	13.0	13.8	•
ZSLNS2018-12		12			3.7		13.7	14.3	14.8	15.3	16.1	•	
ZSLNS2018-14		14			3.3		15.8	16.5	17.0	17.5	18.8	•	
ZSLNS2018-16		16			3.0		17.9	18.6	19.2	19.7	-	•	
ZSLNS2018-18		18			2.7		20.0	20.7	21.3	21.9	-	•	
ZSLNS2018-20		20			2.5		22.1	22.9	23.5	24.1	-	•	
ZSLNS2020-4		2			4		3	1.92	50	4	6.5	5.3	5.6
ZSLNS2020-6	6		5.3	7.4	7.8	8.2					8.5	9.1	•
ZSLNS2020-8	8		4.5	9.5	10.0	10.4					10.8	11.5	•
ZSLNS2020-10	10		3.9	11.6	12.2	12.7			13.1		13.8	•	
ZSLNS2020-12	12		3.4	13.7	14.3	14.9			15.3		16.1	•	
ZSLNS2020-14	14		3.1	15.8	16.5	17.0			17.5		18.8	•	

- No interference

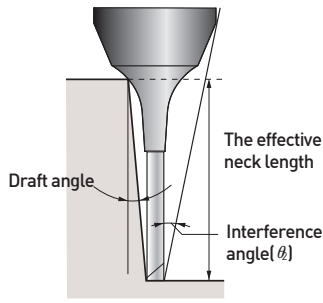

2 FLUTE, LONG NECK

- If the workpiece has draft angle, the interference length will be longer than the L_2 .
- Please refer to the effective neck length for the various draft angles.
- In addition, the angle at which the tool will interfere with the workpiece is shown as the "interference angle θ ", and should also be referred to.

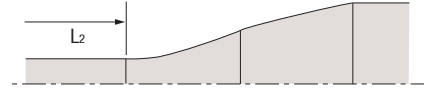

※The effective neck length shown is not an exact value and to avoid contact with the workpiece, we recommend the user control the precise value of this length.

EDP. No.	Dimension(mm)							Effective Neck Length					STOCK
	D	L ₂	L ₁	d ₁	L ₃	d ₃	θ	0.5°	1°	1.5°	2°	3°	
ZSLNS2020-16	2	16	3	1.92	55	4	2.8	17.9	18.6	19.2	19.7	-	•
ZSLNS2020-18		18			60		2.6	20.0	20.8	21.4	21.9	-	•
ZSLNS2020-20		20			65		2.4	22.1	22.9	23.5	24.1	-	•
ZSLNS2020-25		25			70		2.0	27.3	28.2	28.9	-	-	•
ZSLNS2020-30		30			2.8		32.5	33.4	34.4	-	-	•	
ZSLNS2025-8	2.5	8	3.75	2.4	50	4	3.7	9.6	10.1	10.5	10.9	11.5	•
ZSLNS2025-10		10			55		3.1	11.7	12.2	12.7	13.1	13.8	•
ZSLNS2025-12		12			60		2.7	13.8	14.4	14.9	15.3	-	•
ZSLNS2025-14		14			65		2.4	15.9	16.5	17.1	17.5	-	•
ZSLNS2025-16		16			70		2.2	18.0	18.7	19.2	19.7	-	•
ZSLNS2025-18		18			2.0		20.1	20.8	21.4	-	-	•	
ZSLNS2025-20		20			1.8		22.1	22.9	23.5	-	-	•	
ZSLNS2025-25		25			1.5		27.3	28.2	-	-	-	•	
ZSLNS2025-30		30			1.3		32.6	33.5	-	-	-	•	
ZSLNS2030-8	3	8	4.5	2.88	55	6	5.6	9.6	10.1	10.5	10.9	11.5	•
ZSLNS2030-10		10			50		5.0	11.7	12.3	12.7	13.1	13.8	•
ZSLNS2030-12		12			60		4.5	13.8	14.4	14.9	15.4	16.3	•
ZSLNS2030-14		14			65		4.1	15.9	16.6	17.1	17.6	18.9	•
ZSLNS2030-16		16			70		3.7	18.0	18.7	19.3	19.8	21.6	•
ZSLNS2030-18		18			75		3.4	20.1	20.8	21.4	21.9	24.2	•
ZSLNS2030-20		20			80		3.2	22.2	23.0	23.6	24.2	26.9	•
ZSLNS2030-25		25			85		2.7	27.4	28.2	28.9	30.2	-	•
ZSLNS2030-30		30			90		2.4	32.6	33.5	34.5	36.2	-	•
ZSLNS2030-35		35			2.1		37.7	38.7	40.2	42.2	-	•	
ZSLNS2030-40		40			1.9		42.9	43.9	45.9	-	-	•	

- No interference

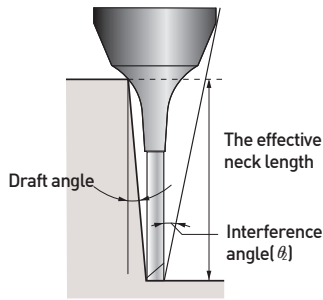

2 FLUTE, LONG NECK

- If the workpiece has draft angle, the interference length will be longer than the L_2 .
- Please refer to the effective neck length for the various draft angles.
- In addition, the angle at which the tool will interfere with the workpiece is shown as the "interference angle θ ", and should also be referred to.

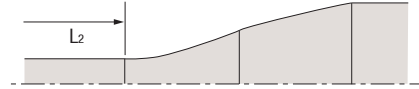

※The effective neck length shown is not an exact value and to avoid contact with the workpiece, we recommend the user control the precise value of this length.

EDP. No.	Dimension(mm)							Effective Neck Length					STOCK
	D	L ₂	L ₁	d ₁	L ₃	d ₃	θ	0.5°	1°	1.5°	2°	3°	
ZSLNS2040-12	4	12	6	3.85	60	6	3.4	13.9	14.5	15.0	15.4	16.3	•
ZSLNS2040-16		16					2.8	18.1	18.8	19.3	19.8	-	•
ZSLNS2040-20		20					2.3	22.3	23.0	23.6	24.3	-	•
ZSLNS2040-25		25			2.0		27.4	28.3	28.9	-	-	•	
ZSLNS2040-30		30			1.7		32.6	33.5	34.6	-	-	•	
ZSLNS2040-35		35			1.5		37.8	38.8	-	-	-	•	
ZSLNS2040-40		40			1.3		42.9	44.0	-	-	-	•	
ZSLNS2040-45		45			1.2		48.1	49.4	-	-	-	•	
ZSLNS2040-50		50			1.1		53.2	54.8	-	-	-	•	
ZSLNS2050-16		5			16		7.5	4.85	60	6	1.5	18.1	18.8
ZSLNS2050-20	20		1.3	22.3	23.0	-					-	-	•
ZSLNS2050-25	25		1.1	27.4	28.3	-			-		-	•	
ZSLNS2050-30	30		0.9	32.6	-	-			-		-	•	
ZSLNS2050-35	35		0.8	37.8	-	-			-		-	•	
ZSLNS2050-40	40		0.7	42.9	-	-			-		-	•	
ZSLNS2050-50	50		0.6	53.2	-	-			-		-	•	

- No interference

■ Tolerance

Diameter	Mill Dia. (mm)	Shank Dia.
0,1 ~ 0,5	0 ~ -0,012	h5
0,6 ~ 4	0 ~ -0,015	

※Items can be changed for quality improvement without notice.

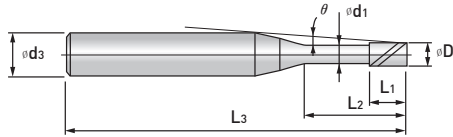

The effective neck length shown is not an exact value and to avoid contact with the workpiece, we recommend the user control the precise value of this length.

ZSLNS40....-.. series



EDP. No.	Dimension(mm)						Effective Neck Length					STOCK	
	D	L ₂	L ₁	d ₁	L ₃	d ₃	θ	0.5°	1°	1.5°	2°		3°
ZSLNS4010-4	1	4	1.5	0.96	50	4	7.7	5.1	5.5	5.8	6.1	6.6	•
ZSLNS4010-6		6					6.6	7.2	7.7	8.1	8.4	9.1	•
ZSLNS4010-8		8					5.7	9.4	9.9	10.4	10.7	11.4	•
ZSLNS4010-10		10					5.0	11.5	12.1	12.6	13.0	13.7	•
ZSLNS4015-4	1.5	4	2.25	1.44	50	4	7.2	5.2	5.5	5.9	6.2	6.7	•
ZSLNS4015-6		6					6.0	7.3	7.8	8.1	8.5	9.1	•
ZSLNS4015-8		8					5.1	9.4	10.0	10.4	10.8	11.5	•
ZSLNS4015-10		10					4.5	11.6	12.1	12.6	13.0	13.8	•
ZSLNS4015-12		12			4.0	13.7	14.3	14.8	15.3	16.1	•		
ZSLNS4015-14		14			3.6	15.8	16.5	17.0	17.5	18.7	•		
ZSLNS4015-16		16			3.3	17.9	18.6	19.2	19.7	-	•		
ZSLNS4015-18		18			3.0	20.0	20.7	21.3	21.9	-	•		
ZSLNS4015-20		20			2.8	22.0	22.9	23.5	24.1	-	•		
ZSLNS4015-25		25			2.4	27.3	28.1	28.8	30.0	-	•		
ZSLNS4020-4	2	4	3	1.92	50	4	6.5	5.3	5.6	5.9	6.2	6.7	•
ZSLNS4020-6		6					5.3	7.4	7.8	8.2	8.5	9.1	•
ZSLNS4020-8		8					4.5	9.5	10.0	10.4	10.8	11.5	•
ZSLNS4020-10		10					3.9	11.6	12.2	12.7	13.1	13.8	•
ZSLNS4020-12		12			3.4	13.7	14.3	14.9	15.3	16.1	•		
ZSLNS4020-14		14			3.1	15.8	16.5	17.0	17.5	18.8	•		
ZSLNS4020-16		16			2.8	17.9	18.6	19.2	19.7	-	•		
ZSLNS4020-18		18			2.6	20.0	20.8	21.4	21.9	-	•		
ZSLNS4020-20		20			2.4	22.1	22.9	23.5	24.1	-	•		
ZSLNS4020-25		25			2.0	27.3	28.2	28.9	-	-	•		
ZSLNS4020-30	30	1.7	32.5	33.4	34.4	-	-	•					
ZSLNS4025-8	2.5	8	3.75	2.4	50	4	3.7	9.6	10.1	10.5	10.9	11.5	•
ZSLNS4025-10		10					3.1	11.7	12.2	12.7	13.1	13.8	•
ZSLNS4025-12		12					2.7	13.8	14.4	14.9	15.3	-	•
ZSLNS4025-14		14					2.4	15.9	16.5	17.1	17.5	-	•
ZSLNS4025-16		16			2.2	18.0	18.7	19.2	19.7	-	•		
ZSLNS4025-18		18			2.0	20.1	20.8	21.4	-	-	•		
ZSLNS4025-20		20			1.8	22.1	22.9	23.5	-	-	•		
ZSLNS4025-25		25			1.5	27.3	28.2	-	-	-	•		
ZSLNS4025-30		30			1.3	32.6	33.5	-	-	-	•		

- No interference

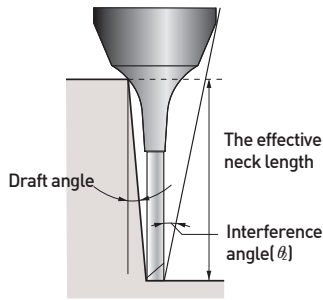

4 FLUTE, LONG NECK

- If the workpiece has draft angle, the interference length will be longer than the L_2 .
- Please refer to the effective neck length for the various draft angles.
- In addition, the angle at which the tool will interfere with the workpiece is shown as the "interference angle θ ", and should also be referred to.

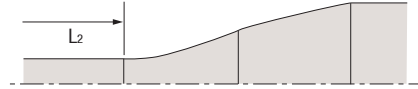

※The effective neck length shown is not an exact value and to avoid contact with the workpiece, we recommend the user control the precise value of this length.

EDP. No.	Dimension(mm)						Effective Neck Length					STOCK	
	D	L ₂	L ₁	d ₁	L ₃	d ₃	θ	0.5°	1°	1.5°	2°		3°
ZSLNS4030-8	3	8	4.5	2.88	55	6	5.6	9.6	10.1	10.5	10.9	11.5	•
ZSLNS4030-10		10					5.0	11.7	12.3	12.7	13.1	13.8	•
ZSLNS4030-12		12					4.5	13.8	14.4	14.9	15.4	16.3	•
ZSLNS4030-14		14			4.1		15.9	16.6	17.1	17.6	18.9	•	
ZSLNS4030-16		16			3.7		18.0	18.7	19.3	19.8	21.6	•	
ZSLNS4030-18		18			3.4		20.1	20.8	21.4	21.9	24.2	•	
ZSLNS4030-20		20			3.2		22.2	23.0	23.6	24.2	26.9	•	
ZSLNS4030-25		25			2.7		27.4	28.2	28.9	30.2	-	•	
ZSLNS4030-30		30			2.4		32.6	33.5	34.5	36.2	-	•	
ZSLNS4030-35		35			2.1		37.7	38.7	40.2	42.2	-	•	
ZSLNS4030-40		40			1.9		42.9	43.9	45.9	-	-	•	
ZSLNS4040-12		4			12		6	3.85	60	6	3.4	13.9	14.5
ZSLNS4040-16	16		2.8	18.1	18.8	19.3					19.8	-	•
ZSLNS4040-20	20		2.3	22.3	23.0	23.6			24.3		-	•	
ZSLNS4040-25	25		2.0	27.4	28.3	28.9			-		-	•	
ZSLNS4040-30	30		1.7	32.6	33.5	34.6			-		-	•	
ZSLNS4040-35	35		1.5	37.8	38.8	-			-		-	•	
ZSLNS4040-40	40		1.3	42.9	44.0	-			-		-	•	
ZSLNS4040-45	45		1.2	48.1	49.4	-			-		-	•	
ZSLNS4040-50	50		1.1	53.2	54.8	-			-		-	•	
ZSLNS4050-16	5	16	7.5	4.85	60	6	1.5	18.1	18.8	-	-	-	•
ZSLNS4050-20		20					1.3	22.3	23.0	-	-	-	•
ZSLNS4050-25		25			1.1		27.4	28.3	-	-	-	•	
ZSLNS4050-30		30			0.9		32.6	-	-	-	-	•	
ZSLNS4050-35		35			0.8		37.8	-	-	-	-	•	
ZSLNS4050-40		40			0.7		42.9	-	-	-	-	•	
ZSLNS4050-40		40			0.7		42.9	-	-	-	-	•	
ZSLNS4050-50		50			0.6		53.2	-	-	-	-	•	

- - - No interference

■ Tolerance

Diameter	Mill Dia. (mm)	Shank Dia.
0,1 ~ 0,5	0 ~ -0,012	h5
0,6 ~ 4	0 ~ -0,015	

※Items can be changed for quality improvement without notice.

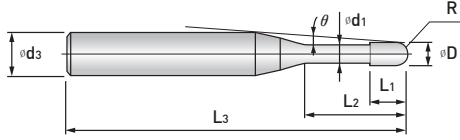

The effective neck length shown is not an exact value and to avoid contact with the workpiece, we recommend the user control the precise value of this length.

ZSLNB..... series

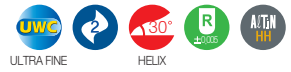

EDP. No.	Dimension(mm)							Effective Neck Length					STOCK	
	R	D	L ₂	L ₁	d ₁	L ₃	d ₃	θ	0.5°	1°	1.5°	2°		3°
ZSLNB2001-0.2	0.05	0.1	0.2	0.08	0.08	45	4	11.8	0.3	0.3	0.3	0.4	0.4	•
ZSLNB2001-0.3			0.3						0.4	0.4	0.5	0.5	0.5	•
ZSLNB2001-0.5			0.5						0.6	0.7	0.7	0.7	0.8	•
ZSLNB2002-0.5	0.1	0.2	0.5	0.15	0.17	50	4	11.5	1.2	1.3	1.5	1.6	2.0	•
ZSLNB2002-1			1						1.7	1.9	2.1	2.3	2.7	•
ZSLNB2002-1.5			1.5						2.3	2.5	2.8	3.0	3.4	•
ZSLNB2002-2			2						2.8	3.1	3.4	3.6	4.1	•
ZSLNB2002-2.5			2.5						3.4	3.7	4.0	4.2	4.7	•
ZSLNB2002-3.0			3						3.9	4.3	4.6	4.9	5.4	•
ZSLNB2003-1			0.15						0.3	1	0.25	0.27	50	4
ZSLNB2003-1.5	1.5	2.3		2.5	2.7	3.0	3.4	•						
ZSLNB2003-2	2	2.8		3.1	3.4	3.6	4.0	•						
ZSLNB2003-2.5	2.5	3.4		3.7	4.0	4.2	4.7	•						
ZSLNB2003-3	3	3.9		4.3	4.6	4.8	5.3	•						
ZSLNB2004-1	0.2	0.4	1	0.3	0.37	50	4	11.0	1.7	1.9	2.1	2.3	2.7	•
ZSLNB2004-1.5			1.5						2.3	2.5	2.7	2.9	3.4	•
ZSLNB2004-2			2						2.8	3.1	3.4	3.6	4.0	•
ZSLNB2004-2.5			2.5						3.4	3.7	4.0	4.2	4.7	•
ZSLNB2004-3			3						3.9	4.3	4.6	4.8	5.3	•
ZSLNB2004-3.5			3.5						4.5	4.8	5.2	5.4	6.0	•
ZSLNB2004-4			4						5.0	5.4	5.7	6.0	6.6	•
ZSLNB2004-4.5			4.5						5.6	6.0	6.3	6.6	7.2	•
ZSLNB2005-1	0.25	0.5	1	0.35	0.47	50	4	11.0	1.7	1.9	2.1	2.3	2.6	•
ZSLNB2005-2			2						2.8	3.1	3.3	3.6	4.0	•
ZSLNB2005-3			3						3.9	4.3	4.6	4.8	5.3	•
ZSLNB2005-4			4						5.0	5.4	5.7	6.0	6.6	•
ZSLNB2005-5			5						6.1	6.5	6.9	7.2	7.8	•
ZSLNB2005-6			6						7.1	7.6	8.0	8.4	9.0	•
ZSLNB2005-7			7						8.2	8.7	9.1	9.5	10.1	•
ZSLNB2005-8			8						9.3	9.9	10.3	10.7	11.4	•

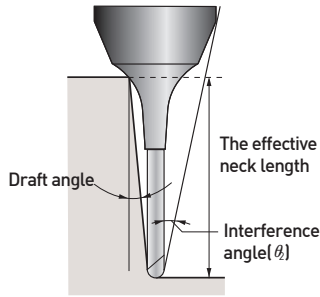

2 FLUTE, LONG NECK

- If the workpiece has draft angle, the interference length will be longer than the L_2 .
- Please refer to the effective neck length for the various draft angles.
- In addition, the angle at which the tool will interfere with the workpiece is shown as the "interference angle θ ", and should also be referred to.

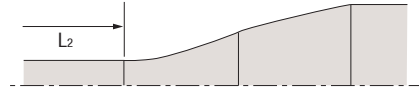

※The effective neck length shown is not an exact value and to avoid contact with the workpiece, we recommend the user control the precise value of this length.

EDP. No.	Dimension(mm)								Effective Neck Length					STOCK
	R	D	L ₂	L ₁	d ₁	L ₃	d ₃	θ	0.5°	1°	1.5°	2°	3°	
ZSLNB2006-1	0.3	0.6	1	0.4	0.57	50	4	11.0	1.7	1.9	2.1	2.3	2.6	•
ZSLNB2006-2			2					9.9	2.8	3.1	3.3	3.6	4.0	•
ZSLNB2006-3			3					9.0	3.9	4.3	4.5	4.8	5.3	•
ZSLNB2006-4			4					8.3	5.0	5.4	5.7	6.0	6.6	•
ZSLNB2006-5			5					7.6	6.1	6.5	6.9	7.2	7.8	•
ZSLNB2006-6			6					7.1	7.2	7.6	8.0	8.4	9.0	•
ZSLNB2006-7			7					6.6	8.3	8.8	9.2	9.5	10.2	•
ZSLNB2006-8			8					6.2	9.3	9.9	10.3	10.7	11.4	•
ZSLNB2006-9			9					5.8	10.4	10.9	11.4	11.8	12.5	•
ZSLNB2006-10			10					5.5	11.4	12.0	12.5	12.9	13.7	•
ZSLNB2006-12			12					5.0	13.6	14.2	14.7	15.2	16.0	•
ZSLNB2008-2			0.4					0.8	2	0.5	0.77	50	4	9.9
ZSLNB2008-4	4	8.2		5.0	5.4	5.7	6.0		6.5					•
ZSLNB2008-5	5	7.5		6.1	6.5	6.9	7.2		7.8					•
ZSLNB2008-6	6	7.0		7.2	7.6	8.0	8.4		9.0					•
ZSLNB2008-8	8	6.1		9.3	9.8	10.3	10.7		11.3					•
ZSLNB2008-10	10	5.4	11.4	12.0	12.5	12.9	13.7	•						
ZSLNB2010-2	0.5	1	2	0.8	0.96	50	4	9.9	2.9	3.1	3.3	3.5	4.0	•
ZSLNB2010-3			3					8.9	4.0	4.3	4.5	4.8	5.3	•
ZSLNB2010-4			4					8.1	5.0	5.4	5.7	6.0	6.5	•
ZSLNB2010-5			5					7.4	6.1	6.5	6.9	7.2	7.8	•
ZSLNB2010-6			6					6.8	7.2	7.7	8.0	8.4	9.0	•
ZSLNB2010-7			7					6.3	8.3	8.8	9.2	9.5	10.2	•
ZSLNB2010-8			8			5.9		9.3	9.9	10.3	10.7	11.3	•	
ZSLNB2010-9			9			5.5		10.4	11.0	11.4	11.8	12.5	•	
ZSLNB2010-10			10			5.2		11.5	12.0	12.5	12.9	13.7	•	
ZSLNB2010-12			12			4.6		13.6	14.2	14.7	15.2	15.9	•	
ZSLNB2010-14			14			4.2		15.7	16.4	16.9	17.4	18.5	•	
ZSLNB2010-16			16			3.8		17.8	18.5	19.1	19.6	21.2	•	
ZSLNB2010-18	18	3.5	19.9	20.7	21.3	21.8	23.8	•						
ZSLNB2010-20	20	3.3	22.0	22.8	23.4	24.0	26.5	•						
ZSLNB2012-4	0.6	1.2	4	1.1	1.15	50	4	7.9	5.1	5.4	5.7	6.0	6.5	•
ZSLNB2012-6			6					6.6	7.2	7.7	8.0	8.4	9.0	•
ZSLNB2012-8			8					5.7	9.4	9.9	10.3	10.7	11.3	•
ZSLNB2012-10			10					5.0	11.5	12.1	12.5	12.9	13.7	•
ZSLNB2012-12			12			4.5		13.6	14.2	14.7	15.2	15.9	•	

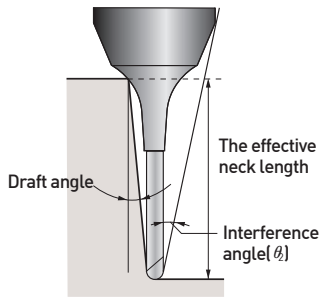

2 FLUTE, LONG NECK

- If the workpiece has draft angle, the interference length will be longer than the L_2 .
- Please refer to the effective neck length for the various draft angles.
- In addition, the angle at which the tool will interfere with the workpiece is shown as the "interference angle θ ", and should also be referred to.

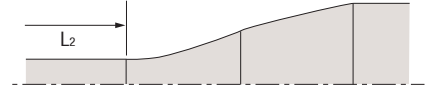

※The effective neck length shown is not an exact value and to avoid contact with the workpiece, we recommend the user control the precise value of this length.

EDP. No.	Dimension(mm)								Effective Neck Length					STOCK
	R	D	L ₂	L ₁	d ₁	L ₃	d ₃	θ	0.5°	1°	1.5°	2°	3°	
ZSLNB2014-8	0.7	1.4	8	1.3	1.34	50	4	5.5	9.4	9.9	10.3	10.7	11.3	•
ZSLNB2014-12			12			55		4.3	13.6	14.2	14.7	15.2	15.9	•
ZSLNB2014-16			16			3.5		17.8	18.5	19.1	19.6	21.2	•	
ZSLNB2015-4	0.75	1.5	4	1.35	1.44	50	4	7.7	5.1	5.4	5.7	6.0	6.5	•
ZSLNB2015-6			6					6.4	7.3	7.7	8.0	8.4	9.0	•
ZSLNB2015-8			8					5.4	9.4	9.9	10.3	10.7	11.3	•
ZSLNB2015-10			10					4.7	11.5	12.1	12.5	12.9	13.7	•
ZSLNB2015-12			12			4.2		13.6	14.2	14.7	15.2	15.9	•	
ZSLNB2015-14			14			3.8		15.7	16.4	16.9	17.4	18.5	•	
ZSLNB2015-16			16			3.4		17.8	18.5	19.1	19.6	21.1	•	
ZSLNB2015-20			20			2.9		22.0	22.8	23.4	24.0	-	•	
ZSLNB2016-8	0.8	1.6	8	1.4	1.54	50	4	5.3	9.4	9.9	10.3	10.7	11.3	•
ZSLNB2016-10			10			4.6		11.5	12.1	12.5	12.9	13.7	•	
ZSLNB2016-12			12			4.1		13.6	14.2	14.7	15.2	15.9	•	
ZSLNB2016-16			16			3.3		17.8	18.5	19.1	19.6	21.1	•	
ZSLNB2016-20			20			2.8		22.0	22.8	23.4	24.0	-	•	
ZSLNB2018-8	0.9	1.8	8	1.6	1.73	50	4	5.1	9.4	9.9	10.3	10.7	11.3	•
ZSLNB2018-12			12			3.9		13.7	14.3	14.7	15.2	15.9	•	
ZSLNB2018-16			16			3.1		17.9	18.6	19.1	19.6	21.1	•	
ZSLNB2018-20			20			2.6		22.0	22.8	23.4	24.0	-	•	
ZSLNB2020-3	1	2	3	*3	1.92	50	4	8.3	4.1	4.4	4.6	4.8	5.2	•
ZSLNB2020-4			4					7.3	5.2	5.5	5.8	6.0	6.5	•
ZSLNB2020-6			6					5.8	7.3	7.7	8.1	8.4	9.0	•
ZSLNB2020-8			8					4.9	9.5	9.9	10.3	10.7	11.3	•
ZSLNB2020-10			10					4.2	11.6	12.1	12.6	12.9	13.6	•
ZSLNB2020-12			12			3.7		13.7	14.3	14.8	15.2	15.9	•	
ZSLNB2020-14			14			3.2		15.8	16.4	16.9	17.4	18.5	•	
ZSLNB2020-16			16			2.9		17.9	18.6	19.1	19.6	-	•	
ZSLNB2020-18			18			2.7		20.0	20.7	21.3	21.8	-	•	
ZSLNB2020-20			20			2.4		22.1	22.8	23.4	24.0	-	•	
ZSLNB2020-22			22			2.3		24.1	24.9	25.6	26.3	-	•	
ZSLNB2020-25			25			2.0		27.3	28.1	28.8	-	-	•	
ZSLNB2020-30			30			1.7		32.4	33.4	34.2	-	-	•	

- No interference

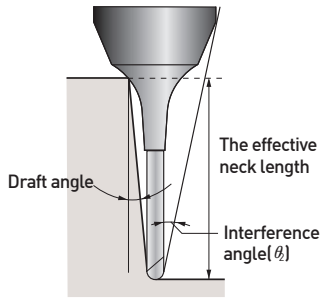

2 FLUTE, LONG NECK

- If the workpiece has draft angle, the interference length will be longer than the L_2 .
- Please refer to the effective neck length for the various draft angles.
- In addition, the angle at which the tool will interfere with the workpiece is shown as the "interference angle θ ", and should also be referred to.



※The effective neck length shown is not an exact value and to avoid contact with the workpiece, we recommend the user control the precise value of this length.

EDP. No.	Dimension(mm)								Effective Neck Length					STOCK					
	R	D	L ₂	L ₁	d ₁	L ₃	d ₃	θ	0.5°	1°	1.5°	2°	3°						
ZSLNB2020-35	1	2	35	*3	1.92	75	4	1.5	37.6	38.6	-	-	-	•					
ZSLNB2020-40			40			80		1.4	42.8	43.8	-	-	-	•					
ZSLNB2025-10	1.25	2.5	10	4	2.4	50	4	3.4	11.6	12.1	12.6	13	13.6	•					
ZSLNB2025-16			16			55		2.3	17.9	18.6	19.1	19.6	-	•					
ZSLNB2025-20			20			60		1.9	22.1	22.8	23.5	-	-	•					
ZSLNB2030-8	1.5	3	8	*4	2.88	55	6	6.2	9.6	10.0	10.4	10.7	11.3	•					
ZSLNB2030-10			10					5.5	11.7	12.2	12.6	13.0	13.6	•					
ZSLNB2030-13			13					4.6	14.8	15.4	15.9	16.3	17.1	•					
ZSLNB2030-16			16			4.0		18.0	18.6	19.1	19.6	21.1	•						
ZSLNB2030-18			18			3.6		20.0	20.7	21.3	21.8	23.7	•						
ZSLNB2030-20			20			3.4		22.1	22.9	23.5	24.0	26.4	•						
ZSLNB2030-25			25			2.8		27.3	28.2	28.8	29.9	-	•						
ZSLNB2030-30			30			2.5		32.5	33.4	34.3	35.9	-	•						
ZSLNB2030-35			35			2.2		37.7	38.7	40.0	41.9	-	•						
ZSLNB2040-10			2			4		10	*5	3.9	55	6	4.5	11.6	12.1	12.5	12.9	13.5	•
ZSLNB2040-13								13					3.6	14.7	15.3	15.8	16.2	17.0	•
ZSLNB2040-16	16	3.1		17.9	18.5		19.1	19.5					20.9	•					
ZSLNB2040-20	20	2.5		22.1	22.8		23.4	23.9			-		•						
ZSLNB2040-25	25	2.1		27.3	28.1		28.8	29.8			-		•						
ZSLNB2040-30	30	1.8		32.4	33.4		34.2	-			-		•						
ZSLNB2040-35	35	1.6		37.6	38.6		39.9	-			-		•						
ZSLNB2040-40	40	1.4		42.8	43.8		-	-			-		•						
ZSLNB2040-45	45	1.2		47.9	49.1		-	-			-		•						
ZSLNB2040-50	50	1.1		53.1	54.5		-	-			-		•						
ZSLNB2050-20	2.5	5		20	*6		4.9	65			6		1.4	22.0	22.8	-	-	-	•
ZSLNB2050-25			25	70		1.2		27.2	28.1	-		-	-	•					
ZSLNB2050-30			30	75		1.0		32.4	-	-		-	-	•					
ZSLNB2050-35			35	80		0.8		42.8	-	-		-	-	•					
ZSLNB2050-40			40	90		0.7		42.8	-	-		-	-	•					

- No interference

■ Tolerance

Radius (mm)	Shank Dia.
±0.005	h5

※Items can be changed for quality improvement without notice.

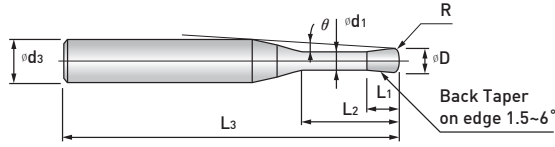

The effective neck length shown is not an exact value and to avoid contact with the workpiece, we recommend the user control the precise value of this length.

ZSLNR..... series

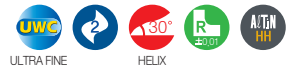

EDP. No.	Dimension(mm)							Effective Neck Length					STOCK		
	D	R	L ₂	L ₁	d ₁	L ₃	d ₃	θ	0.5°	1°	1.5°	2°		3°	
ZSLNR2002-0.5-005	0.2	0.05	0.5	0.15	0.17	50	4	11.4	0.9	1.0	1.0	1.1	1.2	•	
ZSLNR2002-1-005			1						10.9	1.6	1.7	1.9	2.0	2.3	•
ZSLNR2002-1.5-005			1.5						10.3	2.1	2.3	2.5	2.7	3.0	•
ZSLNR2002-2-005			2						9.9	2.8	3.1	3.4	3.6	4.1	•
ZSLNR2003-1-005	0.3	0.05	1	0.25	0.27	50	4	10.8	1.4	1.5	1.6	1.7	1.9	•	
ZSLNR2003-1.5-005			1.5						10.3	2.1	2.3	2.5	2.7	3.0	•
ZSLNR2003-2-005			2						9.8	2.7	2.9	3.1	3.3	3.6	•
ZSLNR2003-2.5-005			2.5						9.4	3.2	3.5	3.7	3.9	4.3	•
ZSLNR2003-3-005			3						9.0	3.9	4.3	4.6	4.9	5.4	•
ZSLNR2004-1-005	0.4	0.05	1	0.3	0.37	50	4	10.8	1.4	1.5	1.6	1.7	1.9	•	
ZSLNR2004-1.5-005			1.5						10.3	2.0	2.1	2.2	2.3	2.5	•
ZSLNR2004-2-005			2						9.8	2.7	2.9	3.1	3.3	3.6	•
ZSLNR2004-2.5-005			2.5						9.4	3.2	3.5	3.7	3.9	4.3	•
ZSLNR2004-3-005			3						9.0	3.8	4.0	4.3	4.5	4.9	•
ZSLNR2004-3.5-005			3.5						8.6	4.3	4.6	4.9	5.1	5.5	•
ZSLNR2004-4-005		4	8.3	5.0	5.4	5.8	6.1	6.6	•						
ZSLNR2004-2-01		0.1	2	0.3	0.37	50	4	10.8	1.4	1.5	1.6	1.7	1.9	•	
ZSLNR2004-3-01			3						9.8	2.7	2.9	3.1	3.3	3.6	•
ZSLNR2004-4-01			4						9.0	3.8	4.0	4.3	4.5	4.9	•
ZSLNR2004-4-01	4		8.3						5.0	5.4	5.8	6.1	6.6	•	
ZSLNR2005-1-005	0.5	0.05	1	0.35	0.47	50	4	10.8	1.4	1.5	1.6	1.7	1.9	•	
ZSLNR2005-2-005			2						9.7	2.5	2.6	2.8	2.9	3.1	•
ZSLNR2005-3-005			3						8.9	3.8	4.0	4.3	4.5	4.9	•
ZSLNR2005-4-005			4						8.2	4.8	5.2	5.4	5.7	6.1	•
ZSLNR2005-5-005			5						7.6	6.1	6.6	6.9	7.3	7.8	•
ZSLNR2005-6-005			6						7.0	7.2	7.7	8.1	8.4	9.0	•
ZSLNR2005-1-01		0.1	1	0.35	0.47	50	4	10.8	1.4	1.5	1.6	1.7	1.9	•	
ZSLNR2005-2-01			2						9.8	2.5	2.6	2.8	2.9	3.1	•
ZSLNR2005-3-01			3						8.9	3.8	4.0	4.3	4.5	4.9	•
ZSLNR2005-3-01			3						8.9	3.8	4.0	4.3	4.5	4.9	•

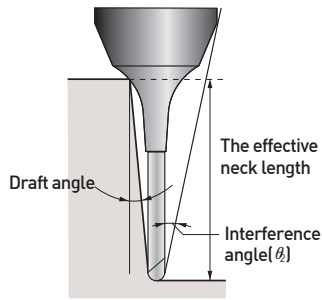

2 FLUTE, LONG NECK BACK DRAFT TYPE

- If the workpiece has draft angle, the interference length will be longer than the L_2 .
- Please refer to the effective neck length for the various draft angles.
- In addition, the angle at which the tool will interfere with the workpiece is shown as the "interference angle θ ", and should also be referred to.

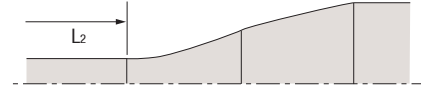

※The effective neck length shown is not an exact value and to avoid contact with the workpiece, we recommend the user control the precise value of this length.

EDP. No.	Dimension(mm)								Effective Neck Length					STOCK
	D	R	L_2	L_1	d_1	L_3	d_3	θ	0.5°	1°	1.5°	2°	3°	
ZSLNR2005-4-01	0.5	0.1	4	0.35	0.47	50	4	8.2	4.8	5.2	5.4	5.7	6.1	•
ZSLNR2005-5-01			5					7.6	6.1	6.5	6.9	7.2	7.8	•
ZSLNR2005-6-01			6					7.1	7.2	7.7	8.1	8.4	9.0	•
ZSLNR2006-2-01	0.6	0.1	2	0.4	0.57	50	4	9.7	2.5	2.6	2.8	2.9	3.1	•
ZSLNR2006-4-01			4					8.1	4.8	5.2	5.4	5.7	6.1	•
ZSLNR2006-6-01			6					7.0	7.2	7.7	8.1	8.4	9.0	•
ZSLNR2006-8-01			8					6.1	9.3	9.9	10.3	10.7	11.4	•
ZSLNR2006-10-01			10					5.5	11.5	12.1	12.5	13.0	13.7	•
ZSLNR2008-4-01	0.8	0.1	4	0.5	0.77	50	4	8.0	4.8	5.2	5.4	5.7	6.1	•
ZSLNR2008-6-01			6					6.8	7.0	7.4	7.7	7.9	8.4	•
ZSLNR2008-8-01			8					5.9	9.3	9.9	10.3	10.7	11.4	•
ZSLNR2008-12-01		12	4.7			13.6		14.2	14.7	15.2	16.0	•		
ZSLNR2008-4-02		0.2	4			50		8.0	4.8	5.1	5.4	5.6	6.1	•
ZSLNR2008-6-02			6					6.9	7.0	7.3	7.7	7.9	8.4	•
ZSLNR2010-4-01	1	0.1	4	0.8	0.94	50	4	7.7	4.7	4.9	5.1	5.2	5.5	•
ZSLNR2010-6-01			6					6.6	7.1	7.4	7.7	8.0	8.5	•
ZSLNR2010-8-01			8					5.7	9.2	9.6	9.9	10.2	10.8	•
ZSLNR2010-10-01			10					5.1	11.6	12.1	12.6	13.0	13.7	•
ZSLNR2010-12-01			12					4.5	13.7	14.3	14.8	15.3	16.0	•
ZSLNR2010-16-01			16					3.8	17.9	18.6	19.2	19.7	21.3	•
ZSLNR2010-20-01		20	3.2			22.0		22.8	23.5	24.0	26.7	•		
ZSLNR2010-4-02		0.2	4			50		7.8	4.7	4.9	5.1	5.2	5.5	•
ZSLNR2010-6-02			6					6.6	7.1	7.4	7.7	8.0	8.5	•
ZSLNR2010-8-02			8					5.8	9.2	9.6	9.9	10.2	10.8	•
ZSLNR2010-10-02			10					5.1	11.6	12.1	12.6	13.0	13.7	•
ZSLNR2010-12-02			12					4.6	13.7	14.3	14.8	15.2	16.0	•
ZSLNR2010-16-02	16		3.8	17.9	18.6		19.2	19.7	21.3	•				
ZSLNR2010-20-02	20	3.2	22.0	22.8	23.5	24.0	26.6	•						

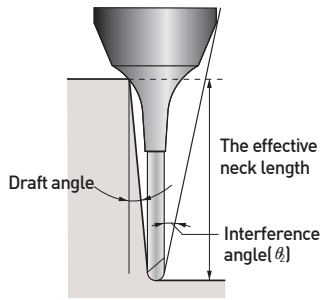

2 FLUTE, LONG NECK BACK DRAFT TYPE

- If the workpiece has draft angle, the interference length will be longer than the L_2 .
- Please refer to the effective neck length for the various draft angles.
- In addition, the angle at which the tool will interfere with the workpiece is shown as the "interference angle θ ", and should also be referred to.



※The effective neck length shown is not an exact value and to avoid contact with the workpiece, we recommend the user control the precise value of this length.

EDP. No.	Dimension(mm)								Effective Neck Length					STOCK								
	D	R	L ₂	L ₁	d ₁	L ₃	d ₃	θ	0.5°	1°	1.5°	2°	3°									
ZSLNR2010-6-03	1	0.3	6	0.8	0.94	50	4	6.7	7.1	7.4	7.7	8.0	8.4	•								
ZSLNR2010-10-03			10					5.1	11.5	12.1	12.6	13.0	13.7	•								
ZSLNR2010-16-03			16					3.8	17.9	18.6	19.1	19.6	21.3	•								
ZSLNR2010-20-03			20					3.2	22.0	22.8	23.5	24.0	26.6	•								
ZSLNR2015-4-01	1.5	0.1	4	1.35	1.42	50	4	7.2	4.8	4.9	5.1	5.3	5.5	•								
ZSLNR2015-8-01			8					5.2	9.2	9.6	10.0	10.3	10.8	•								
ZSLNR2015-12-01			12					4.0	13.4	13.9	14.3	14.7	16.1	•								
ZSLNR2015-15-01			15					3.5	16.9	17.6	18.1	18.6	20.1	•								
ZSLNR2015-20-01		20	2.8			22.1		22.9	23.5	24.1	-	•										
ZSLNR2015-4-02		0.2	4			1.35		1.42	50	4	7.3	4.7	4.9	5.1	5.3	5.5	•					
ZSLNR2015-8-02			8								5.2	9.2	9.6	10.0	10.3	10.8	•					
ZSLNR2015-12-02			12								4.1	13.4	13.9	14.3	14.7	16.1	•					
ZSLNR2015-15-02			15								3.5	16.9	17.5	18.1	18.6	20.0	•					
ZSLNR2015-20-02		20	2.8			22.1		22.9	23.5	24.1	-	•										
ZSLNR2015-8-03		0.3	8			1.35		1.42	50	4	5.2	9.2	9.6	10.0	10.3	10.8	•					
ZSLNR2015-15-03			15								3.5	16.9	17.5	18.1	18.6	20.0	•					
ZSLNR2015-20-03	20		2.8	22.1	22.9		23.5				24.0	-	•									
ZSLNR2020-6-02	2		0.2	6	1.7		1.92				50	4	5.4	6.8	7.1	7.3	7.5	8.1	•			
ZSLNR2020-8-02		8		4.6		8.9		9.2	9.4	9.7			10.8	•								
ZSLNR2020-12-02		12		3.5		13.4		13.9	14.3	14.7			16.1	•								
ZSLNR2020-16-02		16		2.8		17.6		18.1	18.6	19.3			-	•								
ZSLNR2020-20-02		20		2.4		22.1		22.9	23.5	24.1			-	•								
ZSLNR2020-25-02		25		2.0		27.3		28.2	28.8	-			-	•								
ZSLNR2020-30-02		30	1.7	32.5		33.4		34.4	-	-	•											
ZSLNR2020-8-03		0.3	8	1.7		1.92		50	4	4.6	8.9		9.2	9.4	9.7	10.7	•					
ZSLNR2020-16-03			16							2.8	17.6		18.1	18.6	19.3	-	•					
ZSLNR2020-20-03			20							2.4	22.1		22.9	23.5	24.0	-	•					
ZSLNR2020-6-05			0.5							6	1.7		1.92	50	4	5.5	6.8	7.1	7.3	7.4	8.0	•
ZSLNR2020-8-05										8						4.7	8.9	9.2	9.4	9.6	10.7	•

- No interference

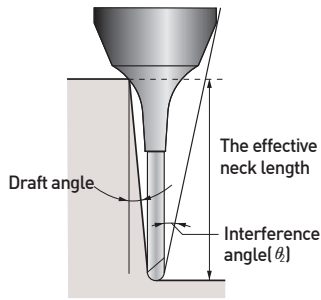

2 FLUTE, LONG NECK BACK DRAFT TYPE

- If the workpiece has draft angle, the interference length will be longer than the L_2 .
- Please refer to the effective neck length for the various draft angles.
- In addition, the angle at which the tool will interfere with the workpiece is shown as the "interference angle θ ", and should also be referred to.

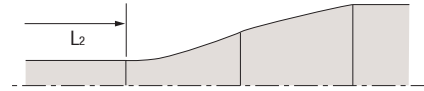

※The effective neck length shown is not an exact value and to avoid contact with the workpiece, we recommend the user control the precise value of this length.

EDP. No.	Dimension(mm)								Effective Neck Length					STOCK
	D	R	L ₂	L ₁	d ₁	L ₃	d ₃	θ	0.5°	1°	1.5°	2°	3°	
ZSLNR2020-12-05	2	0.5	12	1.7	1.92	55	4	3.5	13.4	13.9	14.3	14.6	16.0	●
ZSLNR2020-16-05			16					2.9	17.6	18.1	18.6	19.2	-	●
ZSLNR2020-20-05			20					2.4	22.1	22.9	23.5	24.0	-	●
ZSLNR2020-25-05			25					2.0	27.3	28.1	28.8	-	-	●
ZSLNR2020-30-05		30	1.7			32.5		33.4	34.3	-	-	●		
ZSLNR2020-8-08		0.8	8			50		4.8	8.9	9.2	9.4	9.6	10.6	●
ZSLNR2020-16-08			16			55		2.9	17.6	18.1	18.6	19.2	-	●
ZSLNR2020-20-08			20			60		2.4	22.1	22.8	23.5	24.0	-	●
ZSLNR2030-8-02	3		0.2	8	2.5	2.86	55	6	5.7	9.0	9.3	9.5	9.9	10.9
ZSLNR2030-12-02		12		4.5					13.1	13.5	14.0	14.7	16.2	●
ZSLNR2030-16-02		16		3.8					17.7	18.2	18.7	19.5	21.6	●
ZSLNR2030-20-02		20		3.2					21.8	22.4	23.1	24.2	26.9	●
ZSLNR2030-30-02		30		2.4					32.6	33.5	34.5	36.2	-	●
ZSLNR2030-35-02		35		2.1					37.7	38.7	40.2	42.2	-	●
ZSLNR2030-8-03		0.3	8	55			5.7		9.0	9.3	9.5	9.9	10.9	●
ZSLNR2030-16-03			16	60			3.8		17.7	18.2	18.7	19.4	21.5	●
ZSLNR2030-20-03			20	65			3.2		21.8	22.4	23.1	24.2	26.8	●
ZSLNR2030-30-03			30	75			2.4		32.6	33.5	34.5	36.2	-	●
ZSLNR2030-8-05		0.5	8	55			5.8		9.0	9.3	9.5	9.8	10.8	●
ZSLNR2030-12-05			12	60			4.6		13.1	13.5	13.9	14.6	16.2	●
ZSLNR2030-16-05			16	65			3.8		17.7	18.2	18.7	19.4	21.5	●
ZSLNR2030-20-05			20	75			3.2		21.8	22.4	23.1	24.2	26.8	●
ZSLNR2030-30-05			30	80			2.4		32.6	33.5	34.5	36.1	-	●
ZSLNR2030-35-05			35	80			2.1		37.7	38.7	40.2	42.1	-	●

- No interference

■ Tolerance

Mill Dia. (mm)	Shank Dia.
0 ~ -0,015	h5

※Items can be changed for quality improvement without notice.

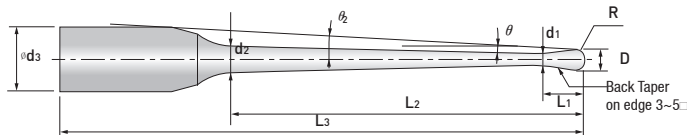

The effective neck length shown is not an exact value and to avoid contact with the workpiece, we recommend the user control the precise value of this length.

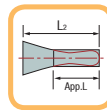

※R2 or higher is not applied to Back draft type.

ZSTNB20..... series



EDP. No.	Dimension(mm)										Effective Neck Length					STOCK	
	R	D	L ₂	θ	L ₁	d ₁	d ₂	L ₃	d ₃	App.L	θ ₂	0.5°	1°	1.5°	2°		3°
ZSTNB2002-1-04	0.1	0.2	1	0.4	0.15	0.17	0.18	50	4	1.35	10.9	1.5	1.7	1.8	2.0	2.3	
ZSTNB2002-1.5-04			1.5	0.4			0.19			1.77	10.4	2.0	2.2	2.4	2.6	2.9	
ZSTNB2002-2-09			2	0.9			0.23			1.10	10.1	x	2.8	3.1	3.4	3.9	
ZSTNB2002-2.5-09			2.5	0.9			0.24			1.10	9.6	x	3.3	3.7	4.0	4.5	
ZSTNB2003-2-04	0.15	0.3	2	0.4	0.25	0.28	0.29	50	4	2.19	10.0	2.5	2.8	3.0	3.2	3.5	
ZSTNB2003-3-09			3	0.9			0.36			1.20	9.3	x	3.8	4.2	4.5	5.1	
ZSTNB2003-4-09			4	0.9			0.39			1.20	8.6	x	4.8	5.3	5.7	6.3	
ZSTNB2004-2-04	0.2	0.4	2	0.4	0.3	0.37	0.39	50	4	2.20	10.0	2.5	2.8	3.0	3.2	3.5	
ZSTNB2004-3-04			3	0.4			0.41			2.44	9.1	3.6	3.9	4.1	4.4	4.8	
ZSTNB2004-4-04			4	0.4			0.42			2.44	8.4	4.7	5.2	5.6	5.9	6.5	
ZSTNB2004-4-09			4	0.9			0.49			1.25	8.5	x	4.8	5.3	5.7	6.3	
ZSTNB2004-5-04			5	0.4			0.44			2.44	7.8	5.7	6.3	6.7	7.1	7.7	
ZSTNB2004-5-09			5	0.9			0.52			1.25	7.9	x	5.9	6.4	6.8	7.5	
ZSTNB2005-4-04	0.25	0.5	4	0.4	0.35	0.47	0.52	50	4	2.49	8.4	4.6	5.0	5.3	5.5	5.9	
ZSTNB2005-8-09			8	0.9			0.71			1.30	6.5	x	8.9	9.6	10.1	10.9	
ZSTNB2005-12-09			12				0.84			1.30	5.3	x	13.0	13.9	14.5	15.4	
ZSTNB20054-2-04	0.27	0.54	2	0.4	0.37	0.52	0.54	50	4	1.80	10.0	2.3	2.5	2.7	2.8	3.0	
ZSTNB20054-4-04			4				0.57			1.80	8.4	4.5	4.9	5.2	5.5	5.9	
ZSTNB20054-5-04			5				0.59			1.80	7.8	5.5	6.0	6.3	6.6	7.1	
ZSTNB20054-6-04			6				0.60			1.80	7.2	6.7	7.3	7.8	8.2	8.8	
ZSTNB20054-6.5-04			6.5				0.61			1.80	7.0	7.2	7.9	8.3	8.7	9.4	
ZSTNB20054-7-04			7				0.61			1.80	6.8	7.7	8.4	8.9	9.3	10.0	
ZSTNB2006-2-04	0.3	0.6	2	0.4	0.4	0.57	0.59	50	4	2.17	10.0	2.4	2.5	2.7	2.8	3.0	
ZSTNB2006-4-04			4				0.62			2.54	8.4	4.6	5.0	5.2	5.5	5.9	
ZSTNB2006-6-04			6				0.65			2.54	7.2	6.8	7.4	7.8	8.2	8.8	
ZSTNB2006-6-09			6	0.9			0.75			1.35	7.3	x	6.9	7.5	7.9	8.6	
ZSTNB2006-8-09			8	0.81			1.35			6.4	x	8.9	9.6	10.1	10.9		
ZSTNB2006-10-04			10	0.4			0.70			2.54	5.6	10.8	11.7	12.2	12.7	13.5	
ZSTNB2006-10-09			10	0.87			1.35			5.7	x	11.0	11.8	12.3	13.2		
ZSTNB2006-12-09			12	0.9			0.93			1.35	5.2	x	13.0	13.9	14.5	15.4	
ZSTNB2006-15-04			15	0.4			0.77			2.54	4.4	15.9	17.0	17.6	18.2	19.2	
ZSTNB2006-15-09			15	0.9			1.03			1.35	4.5	x	16.1	17.1	17.7	18.8	

X No application
- No interference

※ These tools are manufactured based on order received.

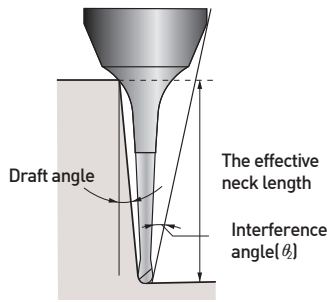

2 FLUTE, TAPER NECK BACK DRAFT TYPE

- If the workpiece has draft angle, the interference length will be longer than the L_2 .
- Please refer to the effective neck length for the various draft angles.
- In addition, the angle at which the tool will interfere with the workpiece is shown as the "interference angle θ ", and should also be referred to.

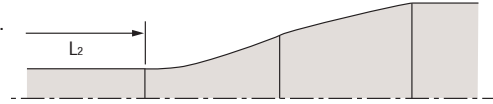

※The effective neck length shown is not an exact value and to avoid contact with the workpiece, we recommend the user control the precise value of this length.

EDP. No.	Dimension(mm)										Effective Neck Length					STOCK	
	R	D	L ₂	θ	L ₁	d ₁	d ₂	L ₃	d ₃	App. L	θ_2	0.5°	1°	1.5°	2°		3°
ZSTNB2008-4-04	0.4	0.8	4	0.4	0.5	0.77	0.82	50	4	2.64	8.3	4.6	4.9	5.2	5.5	5.9	
ZSTNB2008-6-04			6				0.85			2.64	7.1	6.6	7.1	7.5	7.7	8.3	
ZSTNB2008-8-09			8	0.9			1.01	1.45		6.3	x	8.9	9.6	10.1	10.9		
ZSTNB2008-12-09			12				1.13	1.45		5.0	x	13.0	13.9	14.5	15.4		
ZSTNB2008-16-09			16	1.26			1.45	4.2		x	17.1	18.1	18.8	19.9			
ZSTNB2009-4-04	0.45	0.9	4	0.4	0.6	0.86	0.91	50	4	3.46	8.2	4.5	4.7	4.9	5.1	5.4	
ZSTNB2009-8-04			8				0.96	55		3.46	6.1	8.7	9.3	9.7	10.0	10.6	
ZSTNB2009-12-04			12				1.02	3.46		4.8	12.9	13.8	14.4	14.9	15.7		
ZSTNB2009-16-04			16				1.08	3.46		4.0	17.0	18.0	18.7	19.3	20.5		
ZSTNB2009-18-04			18				1.10	3.46		3.7	19.1	20.1	20.9	21.5	23.1		
ZSTNB2009-20-04			20				1.13	3.46		3.4	21.1	22.2	23.0	23.6	25.6		
ZSTNB2009-22-04			22				1.16	3.46		3.2	23.1	24.3	25.1	25.8	28.2		
ZSTNB2009-24-04			24				1.19	3.46		3.0	25.2	26.4	27.2	27.9	-		
ZSTNB2010-6-04	0.5	1	6	0.4	0.8	0.94	1.01	50	6	5.09	8.3	6.8	7.2	7.5	7.8	8.3	
ZSTNB2010-8-04			8				1.04	55		5.09	7.5	8.8	9.3	9.7	10.0	10.6	
ZSTNB2010-10-04			10				1.07	5.09		6.8	11.0	11.7	12.3	12.7	13.5		
ZSTNB2010-10-09			10	0.9			1.23	2.70		6.9	x	11.2	11.9	12.4	13.2		
ZSTNB2010-15-09			15				1.39	60		2.70	5.7	x	16.2	17.1	17.8	18.8	
ZSTNB2010-20-04			20	0.4			1.21	5.09		4.7	21.2	22.3	23.0	23.6	25.7		
ZSTNB2010-20-09			20	0.9			1.54	2.70		4.8	x	21.3	22.4	23.1	24.6		
ZSTNB2010-25-09			25				1.70	70		2.70	4.2	x	26.4	27.6	28.4	30.8	
ZSTNB2010-30-04			30	0.4			1.35	5.09		3.6	31.3	32.7	33.6	34.8	38.5		
ZSTNB2010-30-09			30	0.9			1.86	2.70		3.7	x	31.4	32.8	33.7	36.9		
ZSTNB2010-35-09			35				2.02	80		2.70	3.3	x	36.5	38.0	39.0	43.1	
ZSTNB2010-40-09			40				2.17	85		2.70	3.0	x	41.6	43.2	44.4	-	
ZSTNB2010-50-09			50	2.49			95	2.70		2.5	x	51.7	53.5	55.5	-		
ZSTNB2010-60-09			60	2.80			105	2.70		2.2	x	61.8	63.8	66.6	-		
ZSTNB2010-70-09			70	3.11			115	2.70		1.9	x	71.9	74.0	-	-		
ZSTNB2015-8-04	0.75	1.5	8	0.4	1.35	1.42	1.51	55	6	7.07	7.3	8.9	9.4	9.7	10.0	10.6	
ZSTNB2015-10-04			10				1.54			7.07	6.6	10.9	11.5	11.9	12.2	12.9	

X No application
- No interference

※ These tools are manufactured based on order received.

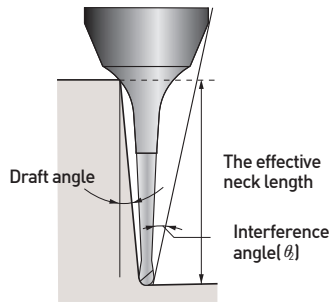

2 FLUTE, TAPER NECK BACK DRAFT TYPE

- If the workpiece has draft angle, the interference length will be longer than the L_2 .
- Please refer to the effective neck length for the various draft angles.
- In addition, the angle at which the tool will interfere with the workpiece is shown as the "interference angle θ ", and should also be referred to.

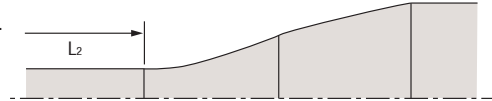

※The effective neck length shown is not an exact value and to avoid contact with the workpiece, we recommend the user control the precise value of this length.

EDP. No.	Dimension(mm)										Effective Neck Length					STOCK						
	R	D	L ₂	θ	L ₁	d ₁	d ₂	L ₃	d ₃	App. L	θ_2	0.5°	1°	1.5°	2°		3°					
ZSTNB2015-12-04	0.75	1.5	12	0.4	1.35	1.42	1.57	55	6	7.07	6.0	13.0	13.6	14.0	14.4	15.4						
ZSTNB2015-15-09			15	0.9			1.85	60		3.89	5.4	x	16.4	17.2	17.8	18.8						
ZSTNB2015-20-09			20				2.01	65		3.89	4.5	x	21.4	22.4	23.2	24.7						
ZSTNB2015-30-09			30				2.32	75		3.89	3.4	x	31.5	32.9	33.7	37.0						
ZSTNB2018-4-04	0.9	1.8	4	0.4	1.6	1.73	1.76	50	6	4.38	9.2	4.6	4.8	4.9	5.1	5.4						
ZSTNB2018-8-04			8				1.82			6.61	7.1	8.6	9.0	9.2	9.4	10.2						
ZSTNB2018-12-04			12				1.88			6.61	5.8	12.9	13.5	14.0	14.4	15.4						
ZSTNB2018-16-04			16				1.93	6.61		4.9	17.0	17.7	18.3	18.7	20.5							
ZSTNB2018-20-04			20				1.99	6.61		4.3	21.2	22.3	23.0	23.6	25.6							
ZSTNB2018-24-04			24				2.04	6.61		3.8	25.3	26.5	27.3	27.9	30.8							
ZSTNB2018-28-04			28				2.10	6.61		3.4	29.4	30.6	31.5	32.4	35.9							
ZSTNB2018-32-04			32				2.15	6.61		3.0	33.4	34.8	35.7	37.1	-							
ZSTNB2018-36-04			36				2.21	6.61		2.8	37.5	38.9	39.9	41.7	-							
ZSTNB2018-38-04			38				2.24	6.61		2.7	39.5	41.0	42.0	44.0	-							
ZSTNB2018-40-04			40				2.27	6.61		2.6	41.5	43.1	44.2	46.3	-							
ZSTNB2020-8-04			1				2	8		0.4	1.7	1.92	2.01	50	6	7.42	7.0	8.7	9.0	9.2	9.5	10.2
ZSTNB2020-12-04	12	2.06		55	7.42	5.7		13.0	13.6				14.0	14.4		15.4						
ZSTNB2020-16-04	16	2.12		60	7.42	4.8		17.0	17.7				18.3	18.7		20.5						
ZSTNB2020-20-04	20	2.18		65	7.42	4.1		21.3	22.3				23.0	23.6		25.6						
ZSTNB2020-20-09	20	2.50		65	4.24	4.2		x	21.4	22.4			23.2	24.6								
ZSTNB2020-25-09	25	2.65		65	4.24	3.6		x	26.5	27.7			28.5	30.8								
ZSTNB2020-30-04	30	2.32		70	7.42	3.1		31.4	32.7	33.6			34.8	38.5								
ZSTNB2020-30-09	30	2.81		70	4.24	3.2		x	31.6	32.9			33.7	36.9								
ZSTNB2020-35-09	35	2.97		75	4.24	2.8		x	36.6	38.0			39.0	-								
ZSTNB2020-40-04	40	2.46		80	7.42	2.5		41.5	43.1	44.2			46.3	-								
ZSTNB2020-40-09	40	3.12		80	4.24	2.6		x	41.7	43.2			44.5	-								
ZSTNB2020-50-09	50	3.44		90	4.24	2.1		x	51.8	53.5			55.5	-								
ZSTNB2020-60-09	60	3.75		100	4.24	1.8		x	61.9	63.8			-	-								
ZSTNB2020-70-09	70	4.07		110	4.24	1.6		x	72.0	74.1			-	-								
ZSTNB2030-8-04	1.5	3		8	0.4	2.5		2.86	2.94	50			6	8.50		6.3	8.8	9.1	9.3	9.5	10.3	
ZSTNB2030-16-04				16					3.05	55				12.52		4.1	17.2	17.8	18.3	18.7	20.6	

X No application
- No interference

※ These tools are manufactured based on order received.

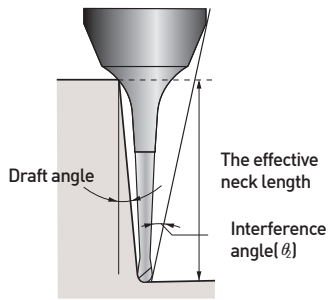

2 FLUTE, TAPER NECK BACK DRAFT TYPE

- If the workpiece has draft angle, the interference length will be longer than the L_2 .
- Please refer to the effective neck length for the various draft angles.
- In addition, the angle at which the tool will interfere with the workpiece is shown as the "interference angle θ ", and should also be referred to.

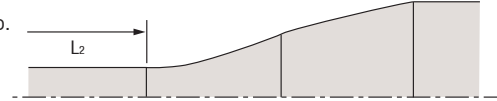

※The effective neck length shown is not an exact value and to avoid contact with the workpiece, we recommend the user control the precise value of this length.

EDP. No.	Dimension(mm)										Effective Neck Length					STOCK		
	R	D	L_2	θ	L_1	d_1	d_2	L_3	d_3	App. L	θ_2	0.5°	1°	1.5°	2°		3°	
ZSTNB2030-20-04	1.5	3	20	0.4	2.5	2.86	3.10	60	6	12.52	3.4	21.2	22.0	22.6	23.3	25.7		
ZSTNB2030-30-04			30				3.24			12.52	2.5	31.6	32.8	33.7	34.9	-		
ZSTNB2030-30-09			30				3.72	6.95		2.6	x	31.8	33.0	33.8	-			
ZSTNB2030-40-04			40	0.4			80	6.95		3.38	12.52	2.0	41.7	43.2	44.3	-	-	
ZSTNB2030-40-09			40	0.9						4.04	6.95	2.0	x	41.9	43.3	-	-	
ZSTNB2030-50-09			50				4.35			6.95	1.7	x	52.0	53.6	-	-		
ZSTNB2030-60-09			60				4.67			6.95	1.4	x	62.1	-	-	-		
ZSTNB2030-70-09			70	4.98			6.95			1.2	x	72.1	-	-	-			
ZSTNB2040-20-10			2	4			20			1	8	3.86	4.28	70	8	12.01	5.0	20.5
ZSTNB2040-30-10	30	4.63			80	12.01	3.51		22.0				31.6	32.5		33.2	34.16	
ZSTNB2040-40-10	40	4.98			90	12.01	2.7		22.0				42.0	43.4		44.3	-	
ZSTNB2040-50-10	50	5.33			100	12.01	2.2		22.0				52.0	53.6		54.7	-	
ZSTNB2040-60-10	60	5.68			110	12.01	1.9	22.0	62.0				63.8	-		-		
ZSTNB2050-30-10	2.5	5	30	1	10	4.86	5.56	80	8	14.01	2.8	25.5	31.7	32.6	33.2	-		
ZSTNB2050-40-10			40				5.91	90		14.01	2.1	25.5	41.7	42.8	43.5	-		
ZSTNB2050-60-10			60				6.61	110		14.01	1.5	25.5	62.1	-	-	-		
ZSTNB2060-30-10	3	6	30	1	12	5.86	6.49	80	8	16.01	1.9	29.0	31.8	32.6	-	-		
ZSTNB2060-40-10			40				6.84	90		16.01	1.5	29.0	41.8	-	-	-		
ZSTNB2060-50-10			50				7.19	100		16.01	1.2	29.0	51.8	-	-	-		
ZSTNB2060-60-10			60				7.54	110	16.01	1.9	29.0	62.2	63.9	-	-			
ZSTNB2060-70-10			70				7.89	120	10	16.01	1.7	29.0	72.2	74.1	-	-		
ZSTNB2060-80-10	80	8.23	130	16.01	1.5	29.0	82.2	-		-	-							
ZSTNB2080-50-10	4	8	50	1	14	7.86	9.12	110	10	18.01	1.2	32.0	51.9	-	-	-		
ZSTNB2080-60-10			60				9.47	120		18.01	1.0	32.0	-	-	-	-		
ZSTNB2080-70-10			70				9.82	130	18.01	0.9	32.0	-	-	-	-			
ZSTNB2080-80-10			80				10.16	140	12	18.01	1.5	32.0	82.3	-	-	-		
ZSTNB2100-60-10	5	10	60	1	18	9.86	11.33	130	12	22.01	1.1	39.0	62.1	-	-	-		
ZSTNB2100-75-10			75				11.85	140		22.01	0.9	39.0	-	-	-	-		

X No application
- No interference

※ These tools are manufactured based on order received.

■ Tolerance

Diameter	Tolerance	Shank Dia.
up to 6	±0.005	h6
over 6	±0.01	

※Items can be changed for quality improvement without notice.

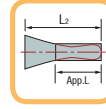
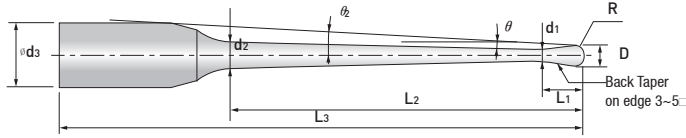

The effective neck length shown is not an exact value and to avoid contact with the workpiece, we recommend the user control the precise value of this length.

※R2 or higher is not applied to Back draft type.

ZSTNB30..... series



EDP. No.	Dimension(mm)										Effective Neck Length					STOCK	
	R	D	L ₂	θ	L ₁	d ₁	d ₂	L ₃	d ₃	App. L	θ ₂	0.5°	1°	1.5°	2°		3°
ZSTNB3020-8-04	1	2	8	0.4	1.7	1.92	2.01	50	6	7.42	7.0	8.7	9.0	9.2	9.5	10.2	
ZSTNB3020-12-04			12				2.06	55		7.42	5.7	13.0	13.6	14.0	14.4	15.4	
ZSTNB3020-16-04			16				2.12	60		7.42	4.8	17.0	17.7	18.3	18.7	20.5	
ZSTNB3020-20-04			20				2.18			7.42	4.1	21.3	22.3	23.0	23.6	25.6	
ZSTNB3020-20-09			20	0.9				4.24		4.2	x	21.4	22.4	23.2	24.6		
ZSTNB3020-25-09			25				2.65			4.24	3.6	x	26.5	27.7	28.5	30.8	
ZSTNB3020-30-04			30	0.4				7.42		3.1	31.4	32.7	33.6	34.8	38.5		
ZSTNB3020-30-09			30	0.9				4.24		3.2	x	31.6	32.9	33.7	36.9		
ZSTNB3020-35-09			35	0.4				4.24		2.8	x	36.6	38.0	39.0	-		
ZSTNB3020-40-04			40				2.46	80		7.42	2.5	41.5	43.1	44.2	46.3	-	
ZSTNB3020-40-09			40	0.9				4.24		2.6	x	41.7	43.2	44.5	-		
ZSTNB3020-50-09			50				3.44	90		4.24	2.1	x	51.8	53.5	55.5	-	
ZSTNB3020-60-09			60	0.4				4.24		1.8	x	61.9	63.8	-	-		
ZSTNB3020-70-09			70				4.07	110		4.24	1.6	x	72.0	74.1	-	-	
ZSTNB3030-8-04	1.5	3	8	0.4	2.5	2.86	2.94	50	6	8.50	6.3	8.8	9.1	9.3	9.5	10.3	
ZSTNB3030-16-04			16				3.05	55		12.52	4.1	17.2	17.8	18.3	18.7	20.6	
ZSTNB3030-20-04			20				3.10	60		12.52	3.4	21.2	22.0	22.6	23.3	25.7	
ZSTNB3030-30-04			30				3.24	70		12.52	2.5	31.6	32.8	33.7	34.9	-	
ZSTNB3030-30-09			30	0.9				6.95		2.6	x	31.8	33.0	33.8	-		
ZSTNB3030-40-04			40	0.4				12.52		2.0	41.7	43.2	44.3	-	-		
ZSTNB3030-40-09			40	0.9				6.95		2.0	x	41.9	43.3	-	-		
ZSTNB3030-50-09			50				4.35	90		6.95	1.7	x	52.0	53.6	-	-	
ZSTNB3030-60-09			60	0.4				6.95		1.4	x	62.1	-	-	-		
ZSTNB3030-70-09			70				4.98	110		6.95	1.2	x	72.1	-	-	-	
ZSTNB3040-20-10	2	4	20	1	8	3.86	4.28	70	8	12.01	5.0	20.5	21.6	22.3	22.8	23.5	
ZSTNB3040-30-10			30				4.63	80		12.01	3.6	22.0	31.6	32.5	33.2	34.1	
ZSTNB3040-40-10			40				4.98	90		12.01	2.7	22.0	42.0	43.4	44.3	-	
ZSTNB3040-50-10			50				5.33	100		12.01	2.2	22.0	52.0	53.6	54.7	-	
ZSTNB3040-60-10			60				5.68	110		12.01	1.9	22.0	62.0	63.8	-	-	
ZSTNB3050-30-10	2.5	5	30	1	10	4.86	5.56	80	8	14.01	2.8	25.5	31.7	32.6	33.2	-	
ZSTNB3050-40-10			40				5.91	90		14.01	2.1	25.5	41.7	42.8	43.5	-	
ZSTNB3050-60-10			60				6.61	110		12.52	1.5	25.5	62.1	-	-	-	

X No application
- No interference

※ These tools are manufactured based on order received.

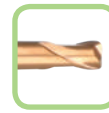
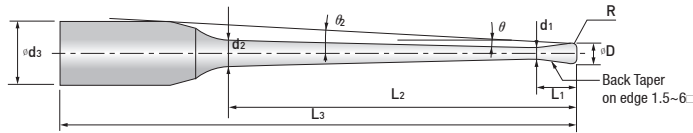

The effective neck length shown is not an exact value and to avoid contact with the workpiece, we recommend the user control the precise value of this length.

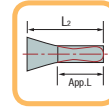

※R2 or higher is not applied to Back draft type.

ZSTNR..... series



EDP. No.	Dimension(mm)										Effective Neck Length					STOCK							
	R	D	L ₂	θ	L ₁	d ₁	d ₂	L ₃	d ₃	App. L	θ ₂	0.5°	1°	1.5°	2°		3°						
ZSTNR2002-2-09005	0.2	0.05	2	0.9	0.15	0.17	0.23	50	4	1.10	10.0	x	2.8	3.1	3.4	3.9							
ZSTNR2004-4-09005	0.4	0.05	4	0.9	0.3	0.37	0.49	50	4	1.25	8.4	x	4.9	5.3	5.7	6.3							
ZSTNR2004-5-09005			5	0.9			0.52			1.25	7.8	x	5.9	6.4	6.8	7.5							
ZSTNR2004-4-0901		0.1	4	0.9			0.49			1.25	8.5	x	4.9	5.3	5.7	6.3							
ZSTNR2004-5-0901			5	0.9			0.52			1.25	7.9	x	5.9	6.4	6.8	7.5							
ZSTNR2005-5-0901	0.5	0.1	5	0.9	0.35	0.47	0.62	50	4	1.30	7.8	x	5.9	6.4	6.8	7.5							
ZSTNR2005-8-0901			8	0.9			0.71			1.30	6.4	x	9.0	9.7	10.2	11.0							
ZSTNR2005-10-0901			10	0.9			0.77			1.30	5.8	x	11.0	11.8	12.4	13.2							
ZSTNR2006-12-0901	0.6	0.1	12	0.9	0.4	0.57	0.93	55	4	1.35	5.1	x	13.0	13.9	14.5	15.5							
ZSTNR2006-15-0901			15	0.9			1.03			1.35	4.5	x	16.1	17.1	17.8	18.8							
ZSTNR2008-6-0402	0.8	0.2	6	0.4	0.5	0.77	0.85	50	4	2.64	7.0	6.6	7.1	7.5	7.8	8.3							
ZSTNR2008-12-0902			12	0.9			1.13			1.45	5.0	x	13.0	13.9	14.5	15.5							
ZSTNR2010-8-0402	1	0.2	8	0.4	0.8	0.94	1.04	55	6	5.09	7.4	8.8	9.3	9.7	10.1	10.6							
ZSTNR2010-10-0902			10	0.9			1.23			5.09	6.8	x	11.2	11.9	12.4	13.3							
ZSTNR2010-15-0902			15	0.9			1.39			2.70	5.6	x	16.3	17.2	17.8	18.8							
ZSTNR2010-20-0902			20	0.9			1.54			2.70	4.8	x	21.3	22.4	23.2	24.7							
ZSTNR2010-25-0902			25	0.9			1.70			2.70	4.1	x	26.4	27.6	28.5	30.9							
ZSTNR2010-30-0902			30	0.9			1.86			2.70	3.7	x	31.5	32.8	33.7	37.0							
ZSTNR2010-35-0902			35	0.9			2.02			2.70	3.3	x	36.5	38.0	39.0	43.2							
ZSTNR2010-8-0403		0.3	8	0.4	0.8	0.94	1.04	55	6	2.70	7.4	8.8	9.3	9.7	10.0	10.6							
ZSTNR2010-15-0903			15	0.9			1.39			2.70	5.6	x	16.3	17.2	17.8	18.8							
ZSTNR2010-25-0903			25	0.9			1.70			2.70	4.2	x	26.4	27.6	28.5	30.8							
ZSTNR2010-30-0903			30	0.9			1.86			2.70	3.7	x	31.5	32.8	33.7	37.0							
ZSTNR2015-10-0402			1.5	0.2			10			0.4	1.35	1.42	1.54	55	6	7.07	6.4	11.0	11.5	11.9	12.3	13.0	
ZSTNR2015-15-0902							15			0.9			1.85			7.07	5.3	x	16.4	17.3	17.9	18.9	
ZSTNR2015-20-0902							20			0.9			2.01			3.89	4.5	x	21.5	22.5	23.2	24.9	
ZSTNR2015-25-0902	25	0.9			2.16	3.89	3.9	x	26.6	27.7			28.5			31.0							
ZSTNR2015-30-0902	30	0.9			2.32	3.89	3.4	x	31.6	32.9			33.8			37.1							
ZSTNR2015-10-0403	0.3	10			0.4	1.54	55	3.89	6.4	11.0			11.5			11.9	12.3	13.0					

X No application
- No interference

※ These tools are manufactured based on order received.

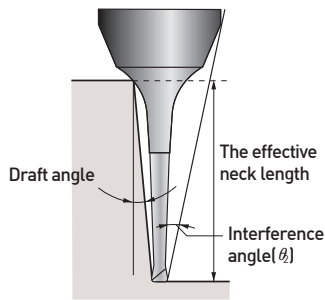

2 FLUTE, TAPER NECK BACK DRAFT TYPE

- If the workpiece has draft angle, the interference length will be longer than the L_2 .
- Please refer to the effective neck length for the various draft angles.
- In addition, the angle at which the tool will interfere with the workpiece is shown as the "interference angle θ ", and should also be referred to.



※The effective neck length shown is not an exact value and to avoid contact with the workpiece, we recommend the user control the precise value of this length.

EDP. No.	Dimension(mm)										Effective Neck Length					STOCK						
	R	D	L_2	θ	L_1	d_1	d_2	L_3	d_3	App. L	θ_2	0.5°	1°	1.5°	2°		3°					
ZSTNR2015-20-0903	1.5	0.3	20	0.9	1.35	1.42	2.01	65	6	3.89	4.5	x	21.5	22.5	23.2	24.8						
ZSTNR2015-25-0903			25				2.16	70			3.9	x	26.5	27.7	28.5	31.0						
ZSTNR2015-30-0903			30				2.32	75			3.4	x	31.6	32.9	33.8	37.1						
ZSTNR2020-30-0902	2	0.2	30	0.9	1.7	1.92	2.81	70	6	7.42	3.1	x	31.6	32.9	33.8	37.2						
ZSTNR2020-40-0902			40				3.12	80			2.5	x	41.8	43.3	44.6	-						
ZSTNR2020-50-0902			50				3.44	90			2.1	x	51.9	53.6	55.7	-						
ZSTNR2020-12-0403			0.3				12	0.4			2.06	55	5.5	13.0	13.6	14.1	14.5	15.6				
ZSTNR2020-20-0903							20				2.50	65	4.1	x	21.5	22.5	23.2	24.9				
ZSTNR2020-30-0903							30				2.81	70	3.1	x	31.6	32.9	33.8	37.1				
ZSTNR2020-40-0903		40	3.12	80			2.5	x			41.7	43.3	44.6	-								
ZSTNR2020-50-0903		50	3.44	90			2.1	x			51.8	53.6	55.7	-								
ZSTNR2020-8-0405		0.5	0.9	8			0.4	2.01			50	6.8	8.7	9.0	9.3	9.5	10.4					
ZSTNR2020-12-0405				12				2.06			55	5.6	13.0	13.6	14.1	14.4	15.5					
ZSTNR2020-16-0405				16				2.12			60	4.7	17.0	17.8	18.3	18.7	20.7					
ZSTNR2020-20-0905				20				2.50			65	4.2	x	21.5	22.5	23.2	24.8					
ZSTNR2020-25-0905				25				2.65			65	3.6	x	26.6	27.7	28.5	30.9					
ZSTNR2020-30-0905				30				2.81			70	3.1	x	31.6	32.9	33.8	37.1					
ZSTNR2020-40-0905				40				3.12			80	2.5	x	41.7	43.2	44.6	-					
ZSTNR2020-50-0905				50				3.44			90	2.1	x	51.8	53.6	55.6	-					
ZSTNR2030-40-0902				3				0.2			40	0.9	2.5	2.86	4.04	80	6	6.95	2.0	x	42.0	43.4
ZSTNR2030-50-0902		50	4.35				90				1.6				x	52.1			53.7	-	-	
ZSTNR2030-60-0902	60	4.67	100		1.4	x	62.2		-	-	-											
ZSTNR2030-40-0903	0.3	40	0.9		4.04	80	2.0	x	42.0	43.4	-				-							
ZSTNR2030-50-0903		50			4.35	90	1.7	x	52.1	53.7	-				-							
ZSTNR2030-60-0903		60			4.67	100	1.4	x	62.2	-	-				-							
ZSTNR2030-40-0905	0.5	40	0.9		4.04	80	2.0	x	42.0	43.4	-				-							
ZSTNR2030-50-0905		50			4.35	90	1.7	x	52.1	53.7	-				-							
ZSTNR2030-60-0905		60			4.67	100	1.4	x	62.1	-	-				-							

X No application
- No interference

※ These tools are manufactured based on order received.

■ Tolerance

Mill Dia. (mm)	Shank Dia.
0 ~ -0.015	h5

※Items can be changed for quality improvement without notice.

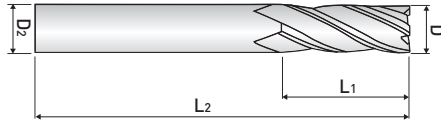

4 FLUTE, LONG CUT LENGTH BROKEN INDEX

- High precision and excellent surface due to each 4F unequal index geometry.
- Longer tool life over 50% as reducing chatter and resonance.

ZS124 ...series



EDP. No.	D	L ₁	L ₂	D ₂	STOCK
ZS124 020	2	5	45	4	•
ZS124 030	3	8	45	6	•
ZS124 040	4	10	45	6	•
ZS124 060	6	16	50	6	•
ZS124 080	8	20	60	8	•
ZS124 100	10	25	75	10	•
ZS124 120	12	35	85	12	•

■ Tolerance

Mill Dia, (mm)	Shank Dia,
0 ~ -0,02	h6

※ Items can be changed for quality improvement without notice.

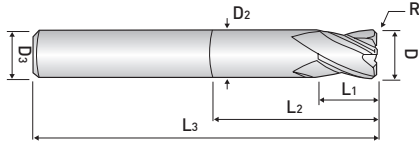

4 FLUTE, CORNER RADIUS BROKEN INDEX

- The impacting debut of new type endmill for high hardened steels up to HRC70 and high speed machining up to 200m/min.
- High precision and excellent surface due to each 4F unequal index geometry.
- Longer tool life over 50% as reducing chatter and resonance.

ZS1(2)04 ...series

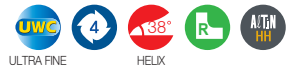

EDP. No.	D	R	L ₁	L ₂	L ₃	D ₂	D ₃	STOCK
ZS104010	1	-	1.5	4	45	0.9	4	•
ZS204010		0.05						•
ZS104020	2	-	3	6	45	1.9	4	•
ZS204020		0.05						•
ZS104030	3	-	4	7	45	2.9	6	•
ZS204030		0.1						•
ZS104040	4	-	5	9	45	3.8	6	•
ZS204040		0.1						•
ZS104060	6	-	7	14	50	5.8	6	•
ZS204060		0.2						•
ZS104080	8	-	9	18	60	7.8	8	•
ZS204080		0.2						•
ZS104100	10	-	12	25	75	9.7	10	•
ZS204100		0.2						•
ZS104120	12	-	15	30	75	11.7	12	•
ZS204120		0.3						•

■ Tolerance

Mill Dia. (mm)	Shank Dia.
0 ~ -0.02	h6

※Items can be changed for quality improvement without notice.

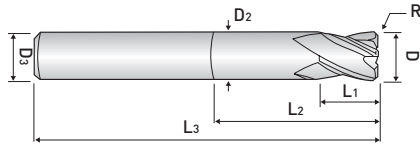

4 FLUTE, CORNER RADIUS BROKEN INDEX

- The impacting debut of new type endmill for high hardened steels up to HRc70 and high speed machining up to 200m/min.
- High precision and excellent surface due to each 4F unequal index geometry.
- Longer tool life over 50% as reducing chatter and resonance.

ZS204series



EDP. No.	D	R	L ₁	L ₂	L ₃	D ₂	D ₃	STOCK
ZS20402000507	2	0.05	2.5	7	50	1.9	4	•
ZS2040200107		0.1						•
ZS2040300109	3	0.1	4	9	55	2.9	6	•
ZS2040300209		0.2						•
ZS2040300309		0.3		12				•
ZS2040300312								•
ZS2040300316	16	•						
ZS2040400212	4	0.2	5	12	55	3.8	6	•
ZS2040400312		0.3		16				•
ZS2040400316				20				•
ZS2040400320		0.5		12				•
ZS2040405012				16				•
ZS2040400516				20				•
ZS2040400520				12				•
ZS2040401012		1		•				
ZS2040500116	5	0.1	6	16	60	4.8	6	•
ZS2040500216		0.2						•
ZS2040500316		0.3						•
ZS2040500516		0.5						•
ZS2040501016		1						•
ZS2040600120	6	0.1	7	20	60	5.8	6	•
ZS2040600220		0.2						•
ZS2040600320		0.3						•
ZS2040600520		0.5						•
ZS2040601020		1						•
ZS2040601520		1.5						•

■ Tolerance

Mill Dia, (mm)	Shank Dia,
0 ~ -0,02	h6

※Items can be changed for quality improvement without notice.

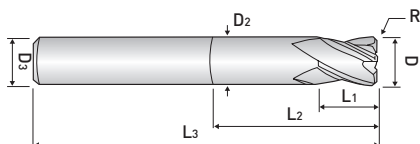

4 FLUTE, CORNER RADIUS BROKEN INDEX

- The impacting debut of new type endmill for high hardened steels up to HRC70 and high speed machining up to 200m/min.
- High precision and excellent surface due to each 4F unequal index geometry.
- Longer tool life over 50% as reducing chatter and resonance.

ZS204series



EDP. No.	D	R	L ₁	L ₂	L ₃	D ₂	D ₃	STOCK
ZS2040800125	8	0.1	9	25	60	8	7.8	•
ZS2040800225		0.2						•
ZS2040800325		0.3						•
ZS2040800525		0.5						•
ZS2040801025		1						•
ZS2040801525		1.5						•
ZS2040802025		2						•
ZS2041000232	10	0.2	11	32	75	10	9.7	•
ZS2041000332		0.3						•
ZS2041000532		0.5						•
ZS2041001032		1						•
ZS2041001532		1.5						•
ZS2041002032		2						•
ZS2041200238	12	0.2	12	38	75	12	11.7	•
ZS2041200338		0.3						•
ZS2041200538		0.5						•
ZS2041201038		1						•
ZS2041201538		1.5						•
ZS2041202038		2						•

■ Tolerance

Mill Dia. (mm)	Shank Dia.
0 ~ -0.02	h6

※Items can be changed for quality improvement without notice.

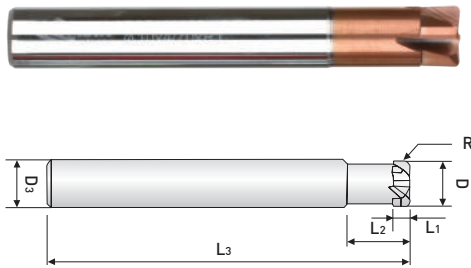

4 FLUTE, STUB CUT LENGTH, with EXTENDED NECK

- Designed to machine high hardened material by using newly developed raw-material and new coating.
- Applying straight flute design on the tool to minimize the corner radius breakage.
- Applying back draft type on the tool to maximize the reducing chatter and preventing deflection.

ZSPM4...-.. series



EDP. No.	D	R	L ₁	L ₂	L ₃	D ₃	STOCK
ZSPM4030-05	3	0.5	1.2	8	50	6	•
ZSPM4040-05	4	0.5	1.5	10	50	6	•
ZSPM4060-05	6	0.5	2.5	12	60	6	•
ZSPM4060-10		1					•
ZSPM4060-15		1.5					•
ZSPM4060-15L							90
ZSPM4080-10	8	1	3.5	16	60	8	•
ZSPM4080-20		2					•
ZSPM4080-20L							100
ZSPM4100-10	10	1	4	20	70	10	•
ZSPM4100-20		2					•
ZSPM4100-20L							100
ZSPM4120-20	12	2	5	25	80	12	•
ZSPM4120-30		3					•
ZSPM4120-30L							110

■ Tolerance

Mill Dia, (mm)	Shank Dia,
0 ~ -0,02	h6

※Items can be changed for quality improvement without notice.

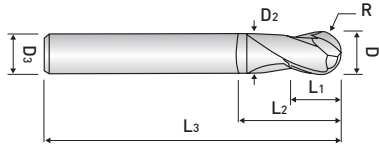

**2 FLUTE, STUB CUT LENGTH, BALL NOSE
with EXTENDED NECK**

- Designed to machine high hardened materials up to HRC 70.
- Suitable for dry cutting & high speed cutting due to newly developed raw-material and new coating.
- Excellent workpiece finishes.

DB702 ...series



EDP. No.	D	R	L ₁	L ₂	L ₃	D ₂	D ₃	STOCK
DB702001	0.1	0.05	0.15	-	40	-	4	•
DB702002	0.2	0.1	0.3	-	40	-	4	•
DB702003	0.3	0.15	0.5	-	40	-	4	•
DB702004	0.4	0.2	0.6	-	40	-	4	•
DB702005	0.5	0.25	0.7	-	40	-	4	•
DB702006	0.6	0.3	0.9	-	40	-	4	•
DB702007	0.7	0.35	1.1	-	40	-	4	•
DB702008	0.8	0.4	1.2	-	40	-	4	•
DB702009	0.9	0.45	1.4	-	40	-	4	•
DB702010S4	1	0.5	1.5	-	45	-	4	•
DB702010				3	50	0.95	6	•
DB702015S4	1.5	0.75	2	-	45	-	4	•
DB702015				4	50	1.45	6	•
DB702020S4	2	1	2.5	-	45	-	4	•
DB702020				5	50	1.9	6	•
DB702025	2.5	1.25	3	7	50	2.45	6	•
DB702030S4	3	1.5	4	-	45	-	4	•
DB702030S				10	50	2.9	6	•
DB702030					60			•
DB702031					70			•
DB702040S4	4	2	5	-	45	-	4	•
DB702040S				10	50	3.9	6	•
DB702040					60			•
DB702041					70			•
DB702050	5	2.5	6	12	60	4.9	6	•
DB702060	6	3	7	12	60	5.9	6	•
DB702061					90	5.9		•
DB702080	8	4	9	15	70	7.9	8	•
DB702081					100	7.9		•
DB702100	10	5	11	25	75	9.9	10	•
DB702101					100	9.9		•
DB702120	12	6	12	25	80	11.9	12	•
DB702121					110	11.9		•

■ Tolerance

Radius (mm)		Shank Dia. h6
up to R3	±0.005	
over R3	±0.01	

※Items can be changed for quality improvement without notice.

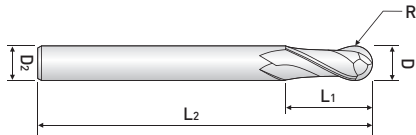

2 FLUTE, REGULAR LENGTH, BALL NOSE

- Designed to machine high hardened material up to HRC 70.
- Suitable for dry cutting & high speed cutting due to newly developed raw-material and new coating.
- Excellent workpiece finishes.

DB712 ...series

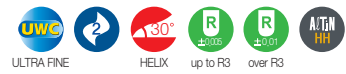

EDP. No.	Dia.	R	L ₁	L ₂	D ₂	STOCK
DB712010S	1	0.5	1.5	40	6	•
DB712010S4			2.5	50	4	•
DB712010					6	•
DB712012	1.2	0.6	3	50	6	•
DB712015S	1.5	0.75	2.5	40	6	•
DB712015S4			4	50	4	•
DB712015					6	•
DB712020S	2	1	3	40	6	•
DB712020S4			5	50	4	•
DB712020					6	•
DB712025	2.5	1.25	7	60	6	•
DB712030S	3	1.5	4.5	50	6	•
DB712030S4			8	60	4	•
DB712030					6	•
DB712040S	4	2	6	50	6	•
DB712040			8	70		•
DB712050S	5	2.5	7.5	50	6	•
DB712050			10	80		•
DB712060S	6	3	9	50	6	•
DB712060			12	90		•
DB712080S	8	4	12	50	8	•
DB712081			14	100		•
DB712100S	10	5	15	60	10	•
DB712100			18	100		•
DB712120S	12	6	18	60	12	•
DB712120			22	110		•

■ Tolerance

Radius (mm)		Shank Dia.
up to R3	±0,005	h6
over R3	±0,01	

※Items can be changed for quality improvement without notice.

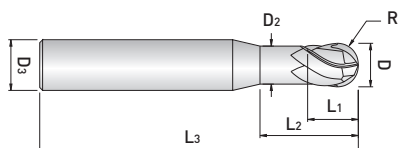

3FLUTE, BALL NOSE for finishing MOLD & DIE

- Designed to machine high hardened material up to HRC 70.
- Suitable for dry cutting & high speed cutting due to newly developed raw-material and new coating.
- Excellent workpiece finishes.

DB703 ...series



EDP. No.	D	R	L ₁	L ₂	L ₃	D ₂	D ₃	STOCK
DB703020	2	1	2.5	5	50	1.9	6	•
DB703025	2.5	1.25	3	7	50	2.4	6	•
DB703030S	3	1.5	4	10	50	2.9	6	•
DB703030					60			•
DB703031					70			•
DB703040S	4	2	5	10	50	3.7	6	•
DB703040					60			•
DB703041					70			•
DB703050	5	2.5	6	12	60	4.7	6	•
DB703060	6	3	7	12	60	5.6	6	•
DB703061					90	5.9		•
DB703080	8	4	9	15	70	7.4	8	•
DB703081					100	7.9		•
DB703100	10	5	11	25	75	9.4	10	•
DB703101					100	9.9		•
DB703120	12	6	12	25	80	11.4	12	•
DB703121					110	11.9		•

■ Tolerance

Radius (mm)		Shank Dia.
up to R3	±0,005	
over R3	±0,01	

※Items can be changed for quality improvement without notice.

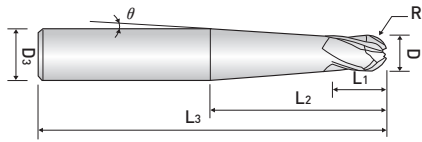

4FLUTE, TAPER NECK, FINISHING MOLD & DIE

- Designed to machine high hardened material up to HRC 70.
- Suitable for dry cutting & high speed cutting due to newly developed raw-material and new coating.
- Excellent workpiece finishes.

DB734 ...series

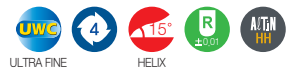

EDP. No.	D	R	L ₁	L ₂	L ₃	θ	D ₃	STOCK
DB734020-2.5	2	1	2	25	60	2.5	4	•
DB734020-3.5				18		3.5		•
DB734025-2.5	2.5	1.25	3	20	60	2.5	4	•
DB734025-3.0				17		3		•
DB734030-2.0	3	1.5	3	46	70	2	6	•
DB734030-2.5				37		2.5		•
DB734040-2.0	4	2.0	4	33	70	2	6	•
DB734040-2.5				27		2.5		•
DB734050-2.5	5	2.5	5	16	70	2.5	6	•
DB734060-1.5	6	3.0	6	44	100	1.5	8	•
DB734060-2.5				29		2.5		•
DB734080-1.5	8	4.0	8	46	100	1.5	10	•
DB734080-2.5				31		2.5		•
DB734100-1.5	10	5.0	10	48	110	1.5	12	•
DB734100-2.5				33		2.5		•

■ Tolerance

Radius (mm)	Shank Dia.
± 0,01	h6

※ Items can be changed for quality improvement without notice.

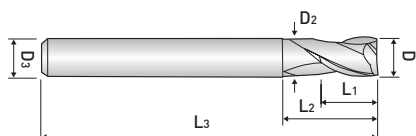

2 FLUTE, STUB CUT LENGTH, with EXTENDED NECK

- Designed to machine high hardened materials up to HRC 70.
- Suitable for dry cutting & high speed cutting due to newly developed raw-material and new coating.

ZE702 ...series



EDP. No.	D	L ₁	L ₂	L ₃	D ₂	D ₃	STOCK
ZE702001	0.1	0.2	-	40	-	4	•
ZE702002	0.2	0.4	-	40	-	4	•
ZE702003	0.3	0.5	-	40	-	4	•
ZE702004	0.4	0.7	-	40	-	4	•
ZE702005	0.5	1	-	40	-	4	•
ZE702006	0.6	1.2	-	40	-	4	•
ZE702007	0.7	1.4	-	40	-	4	•
ZE702008	0.8	1.6	-	40	-	4	•
ZE702009	0.9	2	-	40	-	4	•
ZE702010S4	1	1.5	-	40	-	4	•
ZE702010						6	•
ZE702015	1.5	2.2	-	40	-	6	•
ZE702020S4	2	3	6	40	1.9	4	•
ZE702020s						6	•
ZE702025	2.5	4	6	40	2.4	6	•
ZE702030	3	4	7	45	2.9	6	•
ZE702035	3.5	6	9	45	3.3	6	•
ZE702040	4	6	9	45	3.8	6	•
ZE702045	4.5	6	10	45	4.3	6	•
ZE702050	5	6	11	50	4.8	6	•
ZE702060	6	7	14	50	5.8	6	•
ZE702080	8	9	18	60	7.8	8	•
ZE702100	10	12	25	75	9.7	10	•
ZE702120	12	15	30	75	11.7	12	•
ZE702160	16	18	38	90	15.7	16	•
ZE702200	20	24	45	100	19.7	20	•

■ Tolerance

Mill Dia. (mm)		Shank Dia.
Diameter	Tolerance	
up to 6	0 ~ -0,012	h6
over 6	0 ~ -0,015	

※ Items can be changed for quality improvement without notice.

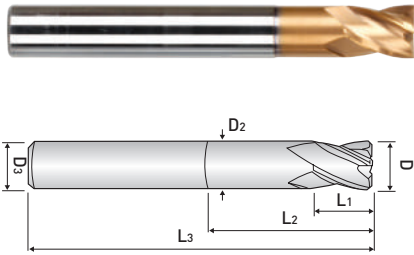

4 FLUTE, STUB CUT LENGTH, with EXTENDED NECK

- Designed to machine high hardened materials up to HRc 70.
- Suitable for dry cutting & high speed cutting due to newly developed raw-material and new coating.

ZE704 ...series



EDP. No.	D	L ₁	L ₂	L ₃	D ₂	D ₃	STOCK
ZE704010S4	1	1.5	-	40	-	4	•
ZE704010						6	•
ZE704015	1.5	2.2	-	40	-	6	•
ZE704020S4	2	3	6	40	1.9	4	•
ZE704020						6	•
ZE704025	2.5	4	6	40	2.4	6	•
ZE704030	3	4	7	45	2.9	6	•
ZE704035	3.5	5	9	45	3.3	6	•
ZE704040	4	5	9	45	3.8	6	•
ZE704045	4.5	6	10	45	4.3	6	•
ZE704050	5	6	11	50	4.8	6	•
ZE704060	6	7	14	50	5.8	6	•
ZE704080	8	9	18	60	7.8	8	•
ZE704100	10	12	25	75	9.7	10	•
ZE704120	12	15	30	75	11.7	12	•
ZE704160	16	18	38	90	15.7	16	•
ZE704200	20	24	45	100	19.7	20	•

■ Tolerance

Mill Dia, (mm)		Shank Dia,
Diameter	Tolerance	
up to 6	0 ~ -0,012	h6
over 6	0 ~ -0,015	

※Items can be changed for quality improvement without notice.

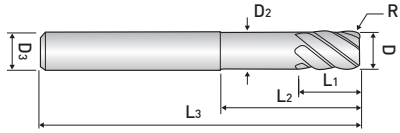

4 & 6 FLUTE, FINISHING for MOLD & DIE

- Designed to machine high hardened materials up to HRC 70.
- Suitable for dry cutting & high speed cutting due to newly developed raw-material and new coating.
- Corner radius (below 0.05) against chipping in high speed machining.

ZE724(6) ...series

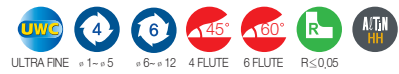

EDP. No.	D	R	L ₁	L ₂	L ₃	D ₂	D ₃	Z	STOCK
ZE724010	1	-	1.5	5	45	0.95	6	4	•
ZE724015	1.5	-	2.2	6	45	1.45	6	4	•
ZE724020	2	0.05	3	8	45	1.9	6	4	•
ZE724030	3	0.05	4	9	50	2.9	6	4	•
ZE724040	4	0.05	5	12	50	3.8	6	4	•
ZE724050	5	0.05	6	15	50	4.8	6	4	•
ZE726060	6	0.05	7	20	60	5.8	6	6	•
ZE726080	8	0.05	9	25	70	7.8	8	6	•
ZE726100	10	0.05	12	32	75	9.7	10	6	•
ZE726120	12	0.05	15	38	80	11.7	12	6	•

■ Tolerance

Mill Dia. (mm)		Shank Dia.
Diameter	Tolerance	
up to 6	0 ~ -0,015	h6
over 6	0 ~ -0,02	

*Items can be changed for quality improvement without notice.

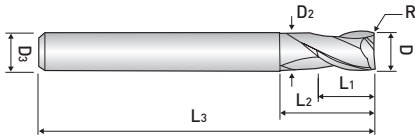

**2 FLUTE, STUB CUT LENGTH,
CORNER RADIUS with EXTENDED NECK**

- Applied various corner "Radius" and effected length.
- Suitable for dry cutting & high speed cutting due to newly developed raw-material and new coating.

ZR702series

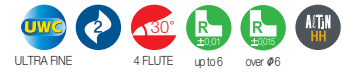

EDP. No.	D	R	L ₁	L ₂	L ₃	D ₂	D ₃	STOCK	
ZR702 010 005 03 S4	1	0.05	1.5	3	50	0.95	4	•	
ZR702 010 005 04 S4				4				•	
ZR702 010 005 06 S4				6				•	
ZR702 010 005 08 S4				8				•	
ZR702 010 005 10 S4				10				•	
ZR702 010 01 03 S4		0.1		0.1				3	•
ZR702 010 01 04 S4								4	•
ZR702 010 01 06 S4								6	•
ZR702 010 01 08 S4								8	•
ZR702 010 01 10 S4								10	•
ZR702 010 02 03 S4		0.2		0.2				3	•
ZR702 010 02 04 S4								4	•
ZR702 010 02 06 S4								6	•
ZR702 010 02 08 S4								8	•
ZR702 010 02 10 S4								10	•
ZR702 010 03 03 S4		0.3		0.3				3	•
ZR702 010 03 04 S4								4	•
ZR702 010 03 06 S4								6	•
ZR702 010 03 08 S4								8	•
ZR702 010 03 10 S4								10	•
ZR702 010 01 04	1	0.1	1.5	4	50	0.95	6	•	
ZR702 010 01 06				6				•	
ZR702 010 02 04		0.2		4				•	
ZR702 010 02 06				6				•	
ZR702 010 02 10				10				•	
ZR702 010 02 12	12	•							
ZR702 012 02 08	1.2	0.2	2	8	50	1.15	6	•	
ZR702 012 02 12				12				•	
ZR702 015 005 04 S4	1.5	0.05	2.5	4	50	1.45	4	•	
ZR702 015 005 06 S4				6				•	
ZR702 015 005 08 S4				8				•	
ZR702 015 005 10 S4				10				•	
ZR702 015 005 12 S4				12				•	
ZR702 015 01 04 S4		0.1		0.1				4	•
ZR702 015 01 06 S4								6	•
ZR702 015 01 08 S4								8	•
ZR702 015 01 10 S4								10	•
ZR702 015 01 12 S4								12	•

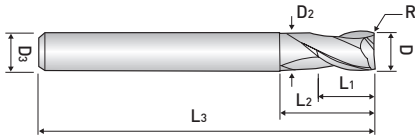

**2 FLUTE, STUB CUT LENGTH,
CORNER RADIUS with EXTENDED NECK**

- Applied various corner "Radius" and effected length.
- Suitable for dry cutting & high speed cutting due to newly developed raw-material and new coating.

ZR702series



EDP. No.	D	R	L ₁	L ₂	L ₃	D ₂	D ₃	STOCK	
ZR702 015 02 04 S4	1.5	0.2	2.5	4	50	1.45	4	•	
ZR702 015 02 06 S4				6				•	
ZR702 015 02 08 S4				8				•	
ZR702 015 02 10 S4				10				•	
ZR702 015 02 12 S4				12				•	
ZR702 015 03 04 S4				4				•	
ZR702 015 03 06 S4		6		•					
ZR702 015 03 08 S4		8		•					
ZR702 015 03 10 S4		10		•					
ZR702 015 03 12 S4		12		•					
ZR702 015 05 04 S4		0.5		0.5				4	•
ZR702 015 05 06 S4								6	•
ZR702 015 05 08 S4	8		•						
ZR702 015 05 10 S4	10		•						
ZR702 015 05 12 S4	12		•						
ZR702 015 02 04	1.5		0.2		2.5	4	50	1.45	6
ZR702 015 02 06		6		•					
ZR702 015 02 08		8		•					
ZR702 015 02 10		10		•					
ZR702 015 02 15		15		•					
ZR702 020 01 06 S4	2	0.1	3	6	50	1.9	4	•	
ZR702 020 01 08 S4				8				•	
ZR702 020 01 10 S4				10				•	
ZR702 020 01 12 S4				12				•	
ZR702 020 01 16 S4				16				•	
ZR702 020 01 20 S4				20				•	
ZR702 020 02 06 S4		0.2		0.2				6	•
ZR702 020 02 08 S4								8	•
ZR702 020 02 10 S4								10	•
ZR702 020 02 12 S4								12	•
ZR702 020 02 16 S4								16	•
ZR702 020 02 20 S4								20	•
ZR702 020 03 06 S4	0.3	0.3	6	•					
ZR702 020 03 08 S4			8	•					
ZR702 020 03 10 S4			10	•					
ZR702 020 03 12 S4			12	•					
ZR702 020 03 16 S4			16	•					
ZR702 020 03 20 S4			2	•					

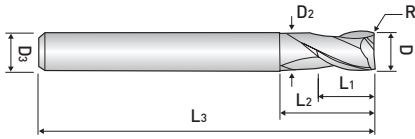

**2 FLUTE, STUB CUT LENGTH,
CORNER RADIUS with EXTENDED NECK**

- Applied various corner "Radius" and effected length.
- Suitable for dry cutting & high speed cutting due to newly developed raw-material and new coating.

ZR702series

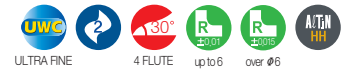

EDP. No.	D	R	L ₁	L ₂	L ₃	D ₂	D ₃	STOCK					
ZR702 020 05 06 S4	2	0.5	3	6	50	1.9	4	•					
ZR702 020 05 08 S4				8				•					
ZR702 020 05 10 S4				10				•					
ZR702 020 05 12 S4				12				•					
ZR702 020 05 16 S4				16				•					
ZR702 020 05 20 S4				20				•					
ZR702 020 01 08	2	0.1	3	8	50	1.9	6	•					
ZR702 020 01 12				12				•					
ZR702 020 02 06		0.2		6				•					
ZR702 020 02 09				9				•					
ZR702 020 02 16		0.3		16				•					
ZR702 020 03 06				6				•					
ZR702 020 05 06		0.5		6				•					
ZR702 020 05 09				9				•					
ZR702 020 05 12				12				•					
ZR702 020 05 16				16				•					
ZR702 025 02 08 S4		2.5		0.2				3.5	8	50	2.4	4	•
ZR702 025 02 10 S4									10				•
ZR702 025 02 12 S4	12		•										
ZR702 025 02 16 S4	16		•										
ZR702 025 03 08 S4	0.3		8	•									
ZR702 025 03 10 S4			10	•									
ZR702 025 03 12 S4			12	•									
ZR702 025 03 16 S4			16	•									
ZR702 025 05 08 S4	0.5		8	•									
ZR702 025 05 10 S4			10	•									
ZR702 025 05 12 S4			12	•									
ZR702 025 05 16 S4			16	•									
ZR702 030 01 08	3	0.1	*4.5	8	55	2.9	6	•					
ZR702 030 01 10				10				•					
ZR702 030 01 12				12				•					
ZR702 030 01 16				16				•					
ZR702 030 01 20				20				60	•				
ZR702 030 02 08				0.2				8	•				
ZR702 030 02 09	9	55	•										
ZR702 030 02 10	10	•											

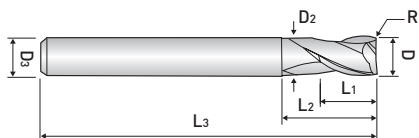

**2 FLUTE, STUB CUT LENGTH,
CORNER RADIUS with EXTENDED NECK**

- Applied various corner "Radius" and effected length.
- Suitable for dry cutting & high speed cutting due to newly developed raw-material and new coating.

ZR702series



EDP. No.	D	R	L ₁	L ₂	L ₃	D ₂	D ₃	STOCK						
ZR702 030 02 12	3	0.2	4.5	12	55	2.9	6	•						
ZR702 030 02 16				16				•						
ZR702 030 02 20				20				60	•					
ZR702 030 03 08	3	0.3	4.5	8	55	2.9	6	•						
ZR702 030 03 09				9				•						
ZR702 030 03 10				10				•						
ZR702 030 03 12				12				•						
ZR702 030 03 14				14				•						
ZR702 030 03 16				16				•						
ZR702 030 03 20				20				60	•					
ZR702 030 05 08				3				0.5	4.5	8	55	2.9	6	•
ZR702 030 05 09										9				•
ZR702 030 05 10										10				•
ZR702 030 05 12										12				•
ZR702 030 05 16	16	•												
ZR702 030 05 20	20	60	•											
ZR702 030 10 08	3	1.0	4.5	8	55	2.9	6	•						
ZR702 030 10 10				10				•						
ZR702 030 10 12				12				•						
ZR702 030 10 16				16				•						
ZR702 030 10 20				20				60	•					
ZR702 030 10 25	25	60	•											
ZR702 040 01 10	4	1.0	6	10	55	3.8	6	•						
ZR702 040 01 12				12				•						
ZR702 040 01 16				16				•						
ZR702 040 01 20				20				60	•					
ZR702 040 01 25				25				60	•					
ZR702 040 02 10		4		0.2	6			10	55	3.8	6	•		
ZR702 040 02 12								12				•		
ZR702 040 02 16								16				•		
ZR702 040 02 20								20				60	•	
ZR702 040 02 25								25				60	•	
ZR702 040 03 10								4				0.3	6	10
ZR702 040 03 12	12	•												
ZR702 040 03 16	16	•												
ZR702 040 03 20	20	60	•											
ZR702 040 03 25	25	60	•											

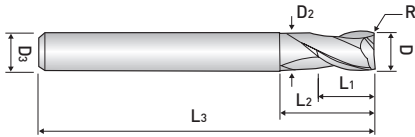

**2 FLUTE, STUB CUT LENGTH,
CORNER RADIUS with EXTENDED NECK**

- Applied various corner "Radius" and effected length.
- Suitable for dry cutting & high speed cutting due to newly developed raw-material and new coating.

ZR702series

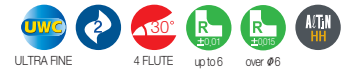

EDP. No.	D	R	L ₁	L ₂	L ₃	D ₂	D ₃	STOCK	
ZR702 040 05 10	4	0.5	6	10	55	3.8	6	•	
ZR702 040 05 12				12				•	
ZR702 040 05 16				16				•	
ZR702 040 05 20				20				•	
ZR702 040 05 25				25				•	
ZR702 040 05 30				30				•	
ZR702 040 10 10		1.0	6	6	10			55	•
ZR702 040 10 12					12				•
ZR702 040 10 16					16				•
ZR702 040 10 20					20				•
ZR702 040 10 25					25				•
ZR702 040 10 30					30				•
ZR702 050 03 18	5	0.3	8	18	60	4.8	6	•	
ZR702 060 02 20	6	0.2	9	20	60	5.8	6	•	
ZR702 060 03 20		0.3						•	
ZR702 060 05 20		0.5						•	
ZR702 060 10 20		1.0						•	
ZR702 060 15 20		1.5						•	
ZR702 060 20 20		2.0						•	
ZR702 080 02 25	8	0.2	12	25	60	7.8	8	•	
ZR702 080 03 25		0.3						•	
ZR702 080 05 25		0.5						•	
ZR702 080 10 25		1.0						•	
ZR702 080 15 25		1.5						•	
ZR702 100 02 32	10	0.2	15	32	70	9.7	10	•	
ZR702 100 03 32		0.3						•	
ZR702 100 05 32		0.5						•	
ZR702 100 10 32		1.0						•	
ZR702 100 15 32		1.5						•	
ZR702 100 20 32		2.0						•	
ZR702 120 03 38	12	0.3	18	38	80	11.7	12	•	
ZR702 120 05 38		0.5						•	
ZR702 120 10 38		1.0						•	
ZR702 120 15 38		1.5						•	
ZR702 120 20 38		2.0						•	

■ Tolerance

Mill Dia, (mm)		Shank Dia,
Diameter	Tolerance	
up to 6	0 ~ -0,012	h6
over 6	0 ~ -0,015	

※Items can be changed for quality improvement without notice.

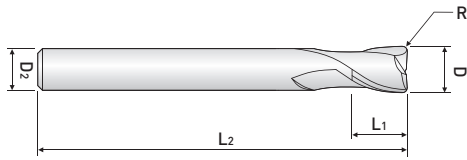

2 FLUTE, LONG SHANK, CORNER RADIUS

- Applied various corner "Radius" and effected length.
- Suitable for dry cutting & high speed cutting due to newly developed raw-material and new coating.

ZR732series



EDP. No.	Dia.	R	L ₁	L ₂	D ₂	STOCK
ZR732 010 01	1	0.1	2	50	6	•
ZR732 010 02		0.2				•
ZR732 010 03		0.3				•
ZR732 015 01	1.5	0.1	3	50	6	•
ZR732 015 02		0.2				•
ZR732 015 03		0.3				•
ZR732 015 05		0.5				•
ZR732 020 01	2	0.1	5	50	6	•
ZR732 020 02		0.2				•
ZR732 020 03		0.3				•
ZR732 020 05		0.5				•
ZR732 025 01	2.5	0.1	7	60	6	•
ZR732 025 02		0.2				•
ZR732 025 03		0.3				•
ZR732 025 05		0.5				•
ZR732 030 01	3	0.1	8	60	6	•
ZR732 030 02		0.2				•
ZR732 030 03		0.3				•
ZR732 030 05		0.5				•
ZR732 040 01	4	0.1	10	70	6	•
ZR732 040 02		0.2				•
ZR732 040 03		0.3				•
ZR732 040 05		0.5				•
ZR732 040 10		1.0				•

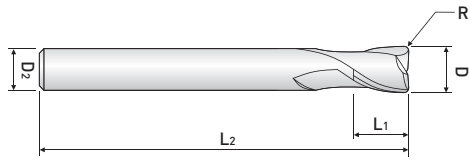

2 FLUTE, LONG SHANK, CORNER RADIUS

- Applied various corner "Radius" and effected length.
- Suitable for dry cutting & high speed cutting due to newly developed raw-material and new coating.

ZR732series

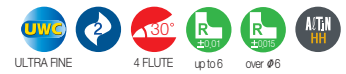

EDP. No.	Dia.	R	L ₁	L ₂	D ₂	STOCK
ZR732 050 01	5	0.1	13	80	6	•
ZR732 050 02		0.2				•
ZR732 050 03		0.3				•
ZR732 050 05		0.5				•
ZR732 050 10		1.0				•
ZR732 060 01	6	0.1	15	90	6	•
ZR732 060 02		0.2				•
ZR732 060 03		0.3				•
ZR732 060 05		0.5				•
ZR732 060 10		1.0				•
ZR732 080 01	8	0.1	20	100	8	•
ZR732 080 02		0.2				•
ZR732 080 03		0.3				•
ZR732 080 05		0.5				•
ZR732 080 10		1.0				•
ZR732 080 20		2.0				•
ZR732 100 02	10	0.2	25	100	10	•
ZR732 100 03		0.3				•
ZR732 100 05		0.5				•
ZR732 100 10		1.0				•
ZR732 100 20		2.0				•
ZR732 120 02	12	0.2	30	110	12	•
ZR732 120 03		0.3				•
ZR732 120 05		0.5				•
ZR732 120 10		1.0				•
ZR732 120 20		2.0				•

■ Tolerance

Mill Dia, (mm)		Shank Dia,
Diameter	Tolerance	
up to 6	0 ~ -0,012	h6
over 6	0 ~ -0,015	

※Items can be changed for quality improvement without notice.

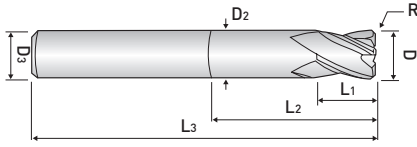

**4 FLUTE, STUB CUT LENGTH,
CORNER RADIUS with EXTENDED NECK**

- Applied various corner "Radius" and effected length.
- Suitable for dry cutting & high speed cutting due to newly developed raw-material and new coating.

ZR704series



EDP. No.	D	R	L ₁	L ₂	L ₃	D ₂	D ₃	STOCK	
ZR704 010 01 03 S4	1	0.1	2	3	50	0.95	4	•	
ZR704 010 01 04 S4				4				•	
ZR704 010 01 06 S4				6				•	
ZR704 010 02 03 S4		0.2		3				•	
ZR704 010 02 04 S4				4				•	
ZR704 010 02 06 S4				6				•	
ZR704 010 03 03 S4		0.3		3				•	
ZR704 010 03 04 S4				4				•	
ZR704 010 03 06 S4				6				•	
ZR704 015 01 04 S4	1.5	0.1	2.5	4	50	1.45	4	•	
ZR704 015 01 06 S4				6				•	
ZR704 015 02 04 S4		0.2		4				•	
ZR704 015 02 06 S4				6				•	
ZR704 015 03 04 S4				4				•	
ZR704 015 03 06 S4	6	•							
ZR704 020 01 06 S4	2	0.1	3	6	50	1.9	4	•	
ZR704 020 01 08 S4				8				•	
ZR704 020 02 06 S4		0.2		6				•	
ZR704 020 02 08 S4				8				•	
ZR704 020 03 06 S4				6				•	
ZR704 020 03 08 S4		0.3		8				•	
ZR704 020 05 06 S4				6				•	
ZR704 020 05 08 S4				8				•	
ZR704 020 02 08	2	0.2	3	8	50	1.9	6	•	
ZR704 020 02 10				10				•	
ZR704 020 02 12				12				•	
ZR704 025 01 06 S4	2.5	0.1	3.5	6	50	2.4	4	•	
ZR704 030 01 08	3	0.1	4	8	55	2.9	6	•	
ZR704 030 01 10				10				•	
ZR704 030 01 12				12				•	
ZR704 030 01 16				16				•	
ZR704 030 01 20				20				•	
ZR704 030 02 08		0.2		8	55			8	•
ZR704 030 02 10				10				•	
ZR704 030 02 12				12				•	
ZR704 030 02 16				16				•	
ZR704 030 02 20				20				•	

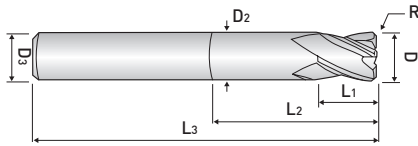

**4 FLUTE, STUB CUT LENGTH,
CORNER RADIUS with EXTENDED NECK**

- Applied various corner "Radius" and effected length.
- Suitable for dry cutting & high speed cutting due to newly developed raw-material and new coating.

ZR704series



EDP. No.	D	R	L ₁	L ₂	L ₃	D ₂	D ₃	STOCK								
ZR704 030 03 08	3	0.3	4	8	55	2.9	6	•								
ZR704 030 03 09				9				•								
ZR704 030 03 10				10				•								
ZR704 030 03 12				12				•								
ZR704 030 03 16				16				•								
ZR704 030 03 20				20				60	•							
ZR704 030 05 08		0.5		8	4			8	55	2.9	6	•				
ZR704 030 05 09				9				9				•				
ZR704 030 05 10				10				10				•				
ZR704 030 05 12				12				12				•				
ZR704 030 05 16				16				16				•				
ZR704 030 05 20				20				60				•				
ZR704 030 10 08	1.0	8	4	8	55	2.9	6	•								
ZR704 030 10 10		10		10				•								
ZR704 030 10 12		12		12				•								
ZR704 030 10 16		16		16				•								
ZR704 030 10 20		20		60				•								
ZR704 040 01 10		4		0.1				6	10			55	3.8	6	•	
ZR704 040 01 12	12				12				•							
ZR704 040 01 16	16				16				•							
ZR704 040 01 20	20				60				•							
ZR704 040 01 25	25				60				•							
ZR704 040 02 10	0.2				10				6	10	55				3.8	6
ZR704 040 02 12				12	12					•						
ZR704 040 02 16			16	16	•											
ZR704 040 02 20			20	60	•											
ZR704 040 02 25			25	60	•											
ZR704 040 03 10			0.3	10	6	10	55			3.8		6				
ZR704 040 03 12	12			12		•										
ZR704 040 03 16	16			16		•										
ZR704 040 03 20	20			60		•										
ZR704 040 03 25	25			60		•										
ZR704 040 05 10	0.5			10		6			10		55					
ZR704 040 05 12			12	12	•											
ZR704 040 05 16			16	16	•											
ZR704 040 05 20			20	60	•											
ZR704 040 05 25			25	60	•											

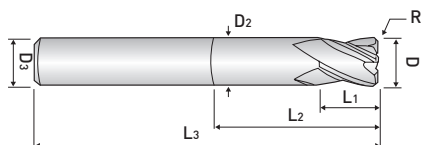

**4 FLUTE, STUB CUT LENGTH,
CORNER RADIUS with EXTENDED NECK**

- Applied various corner "Radius" and effected length.
- Suitable for dry cutting & high speed cutting due to newly developed raw-material and new coating.

ZR704series



EDP. No.	D	R	L ₁	L ₂	L ₃	D ₂	D ₃	STOCK
ZR704 040 10 10	4	1.0	6	10	55	3.8	6	•
ZR704 040 10 12				12				•
ZR704 040 10 16				16				•
ZR704 040 10 20				20	•			
ZR704 040 10 25				25	60			•
ZR704 060 02 20	6	0.2	9	20	60	5.8	6	•
ZR704 060 03 20		0.3						•
ZR704 060 05 20		0.5						•
ZR704 060 10 20		1.0						•
ZR704 060 15 20		1.5						•
ZR704 060 20 20		2.0						•
ZR704 080 02 25	8	0.2	12	25	60	7.8	8	•
ZR704 080 03 25		0.3						•
ZR704 080 05 25		0.5						•
ZR704 080 10 25		1.0						•
ZR704 080 15 25		1.5						•
ZR704 080 20 25		2.0						•
ZR704 100 02 32	10	0.2	15	32	70	9.7	10	•
ZR704 100 03 32		0.3						•
ZR704 100 05 32		0.5						•
ZR704 100 10 32		1.0						•
ZR704 100 15 32		1.5						•
ZR704 100 20 32		2.0						•
ZR704 120 03 38	12	0.3	18	38	80	11.7	12	•
ZR704 120 05 38		0.5						•
ZR704 120 10 38		1.0						•
ZR704 120 15 38		1.5						•
ZR704 120 20 38		2.0						•

■ Tolerance

Mill Dia. (mm)		Shank Dia.
Diameter	Tolerance	
up to 6	0 ~ -0,012	h6
over 6	0 ~ -0,015	

※Items can be changed for quality improvement without notice.

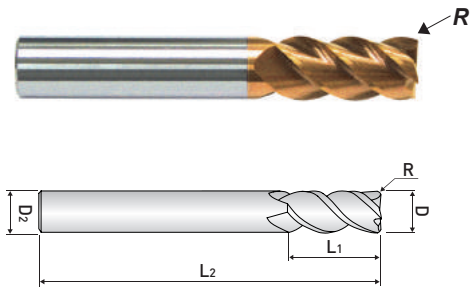

4FLUTE, 45° HELIX FINISHING MOLD & DIE

- Designed to machine high hardened material up to HRc 70.
- Suitable for dry cutting & high speed cutting due to newly developed raw-material and new coating.
- Possible to reduce machining cycle time by 2 x D finishing performance.

ZR714..... series

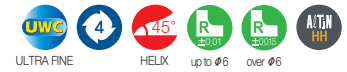

EDP. No.	Dia.	R	L ₁	L ₂	D ₂	STOCK
ZR7140303	3	0.3	8	50	6	•
ZR7140305		0.5				•
ZR7140403	4	0.3	11	50	6	•
ZR7140405		0.5				•
ZR7140410		1.0				•
ZR7140603	6	0.3	15	60	6	•
ZR7140605		0.5				•
ZR7140610		1.0				•
ZR7140803	8	0.3	20	60	8	•
ZR7140805		0.5				•
ZR7140810		1.0				•
ZR7140815		1.5				•
ZR7140820		2.0				•
ZR7141003	10	0.3	25	70	10	•
ZR7141005		0.5				•
ZR7141010		1.0				•
ZR7141015		1.5				•
ZR7141020		2.0				•
ZR7141025		2.5				•
ZR7141030	3.0	•				
ZR7141203	12	0.3	30	80	12	•
ZR7141205		0.5				•
ZR7141210		1.0				•
ZR7141215		1.5				•
ZR7141220		2.0				•
ZR7141225		2.5				•
ZR7141230	3.0	•				

■ Tolerance

Mill Dia. (mm)		Shank Dia.
Diameter	Tolerance	
up to 6	0 ~ -0,012	h6
over 6	0 ~ -0,015	

※Items can be changed for quality improvement without notice.

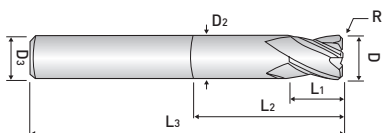

**4 FLUTE, STUB CUT LENGTH,
CORNER RADIUS with LONG SHANK**

- Applied various corner "Radius" and effected length.
- Suitable for dry cutting & high speed cutting due to newly developed raw-material and new coating.

ZR724series



EDP. No.	D	R	L ₁	L ₂	L ₃	D ₂	D ₃	STOCK
ZR7240600520	6	0.5	9	20	90	5.8	6	•
ZR7240601020		1.0						•
ZR7240800525	8	0.5	12	25	100	7.7	8	•
ZR7240801025		1.0						•
ZR7241000532	10	0.5	15	32	100	9.7	10	•
ZR7241001032		1.0						•
ZR7241002032		2.0						•
ZR7241200538	12	0.5	18	38	110	11.7	12	•
ZR7241201038		1.0						•
ZR7241202038		2.0						•

■ Tolerance

Mill Dia. (mm)		Shank Dia.
Diameter	Tolerance	
up to 6	0 ~ -0,012	h6
over 6	0 ~ -0,015	

*Items can be changed for quality improvement without notice.

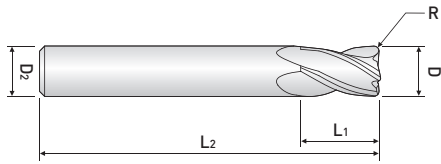

4 FLUTE, LONG SHANK, CORNER RADIUS

- Applied various corner "Radius" and effected length.
- Suitable for dry cutting & high speed cutting due to newly developed raw-material and new coating.

ZR734..... series



EDP. No.	Dia.	R	L ₁	L ₂	D ₂	STOCK
ZR734 010 01	1	0.1	2	50	6	•
ZR734 010 02		0.2				•
ZR734 010 03		0.3				•
ZR734 015 01	1.5	0.1	3	50	6	•
ZR734 015 02		0.2				•
ZR734 015 03		0.3				•
ZR734 015 05		0.5				•
ZR734 020 01	2	0.1	5	50	6	•
ZR734 020 02		0.2				•
ZR734 020 03		0.3				•
ZR734 020 05		0.5				•
ZR734 025 01	2.5	0.1	7	60	6	•
ZR734 025 02		0.2				•
ZR734 025 03		0.3				•
ZR734 025 05		0.5				•
ZR734 030 01	3	0.1	8	60	6	•
ZR734 030 02		0.2				•
ZR734 030 03		0.3				•
ZR734 030 05		0.5				•
ZR734 040 01	4	0.1	10	70	6	•
ZR734 040 02		0.2				•
ZR734 040 03		0.3				•
ZR734 040 05		0.5				•
ZR734 040 10		1.0				•

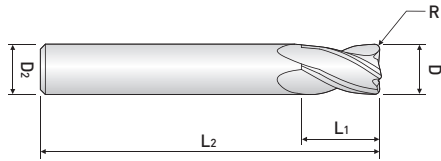

4 FLUTE, LONG SHANK, CORNER RADIUS

- Applied various corner "Radius" and effected length.
- Suitable for dry cutting & high speed cutting due to newly developed raw-material and new coating.

ZR734..... series



EDP. No.	Dia.	R	L ₁	L ₂	D ₂	STOCK
ZR734 050 01	5	0.1	13	80	6	•
ZR734 050 02		0.2				•
ZR734 050 03		0.3				•
ZR734 050 05		0.5				•
ZR734 050 10		1.0				•
ZR734 060 01	6	0.1	15	90	6	•
ZR734 060 02		0.2				•
ZR734 060 03		0.3				•
ZR734 060 05		0.5				•
ZR734 060 10		1.0				•
ZR734 080 01	8	0.1	20	100	8	•
ZR734 080 02		0.2				•
ZR734 080 03		0.3				•
ZR734 080 05		0.5				•
ZR734 080 10		1.0				•
ZR734 080 20		2.0				•
ZR734 100 02	10	0.2	25	100	10	•
ZR734 100 03		0.3				•
ZR734 100 05		0.5				•
ZR734 100 10		1.0				•
ZR734 100 20		2.0				•
ZR734 120 02	12	0.2	30	110	12	•
ZR734 120 03		0.3				•
ZR734 120 05		0.5				•
ZR734 120 10		1.0				•
ZR734 120 20		2.0				•

■ Tolerance

Mill Dia. (mm)		Shank Dia.
Diameter	Tolerance	
up to 6	0 ~ -0,012	h6
over 6	0 ~ -0,015	

※ Items can be changed for quality improvement without notice.

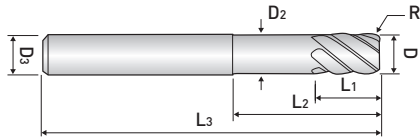

6 FLUTE, 45° HELIX STUB CUT LENGTH, CORNER RADIUS with EXTENDED NECK

- Applied various corner "Radius" and effected length.
- Suitable for dry cutting & high speed cutting due to newly developed raw-material and new coating.

ZR706series



EDP. No.	D	R	L ₁	L ₂	L ₃	D ₂	D ₃	STOCK
ZR7060600314	6	0.3	12	14	50	5.8	6	•
ZR7060600514		0.5						•
ZR7060800524	8	0.5	8	24	60	7.8	8	•
ZR7060801024		1.0						•
ZR7061000530	10	0.5	10	30	70	9.8	10	•
ZR7061001030		1.0						•
ZR7061200530	12	0.5	12	30	75	11.8	12	•
ZR7061201030		1.0						•

■ Tolerance

Mill Dia, (mm)	Shank Dia,
0 ~ -0,02	h6

※ Items can be changed for quality improvement without notice.

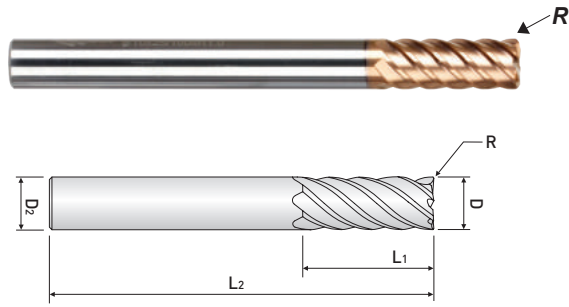

**6 FLUTE, 45°HELIX, LONG SHANK,
CORNER RADIUS**

- Applied various corner "Radius" and effected length.
- Suitable for dry cutting & high speed cutting due to newly developed raw-material and new coating.

ZR736 ...series

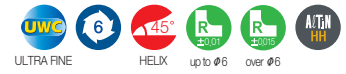

EDP. No.	Dia.	R	L ₁	L ₂	D ₂	STOCK
ZR736 060 05	6	0.5	15	90	6	•
ZR736 060 10		1.0				•
ZR736 080 05	8	0.5	20	100	8	•
ZR736 080 10		1.0				•
ZR736 100 05	10	0.5	25	100	10	•
ZR736 100 10		1.0				•
ZR736 120 05	12	0.5	30	110	12	•
ZR736 120 10		1.0				•

■ Tolerance

Mill Dia. (mm)	Shank Dia.
0 ~ -0,02	h6

※Items can be changed for quality improvement without notice.

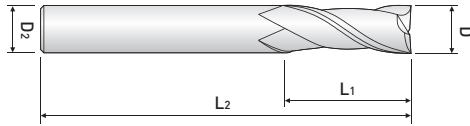

2 FLUTE, 35° HELIX REGULAR LENGTH

- Designed to machine high hardened materials up to HRC 70.
- Suitable for dry cutting & high speed cutting due to newly developed raw-material and new coating.

ZE712 ...series



EDP. No.	Dia.	L ₁	L ₂	D ₂	STOCK
ZE712010-02	1.0	2	40	6	•
ZE712010		3			•
ZE712010-04		4			•
ZE712012	1.2	3	40	6	•
ZE712015	1.5	4	40	6	•
ZE712015-06		6			•
ZE712015-08		8			•
ZE712020	2.0	5	40	6	•
ZE712020-08		8			•
ZE712020-10		10			50
ZE712025	2.5	6	40	6	•
ZE712030	3.0	8	45	6	•
ZE712030-10		10	50		•
ZE712030-12		12			•
ZE712035	3.5	10	45	6	•
ZE712040	4.0	10	45	6	•
ZE712040-12		12	50		•
ZE712040-16		16	60		•
ZE712045	4.5	11	45	6	•
ZE712050	5.0	13	50	6	•
ZE712055	5.5	13	50	6	•
ZE712060	6.0	13	50	6	•
ZE712060-15		15	60		•
ZE712065	6.5	16	60	8	•
ZE712070	7.0	18	60	8	•
ZE712080	8.0	19	60	8	•
ZE712100	10.0	22	70	10	•
ZE712100-25		25			•
ZE712120	12.0	26	75	12	•
ZE712120-30		30	80		•

■ Tolerance

Mill Dia, (mm)	Shank Dia,
0 ~ -0,02	h6

※ Items can be changed for quality improvement without notice.

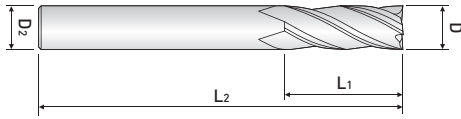

4 FLUTE, 45° HELIX REGULAR LENGTH

- Designed to machine high hardened materials up to HRc 70.
- Suitable for dry cutting & high speed cutting due to newly developed raw-material and new coating.

ZE714 ...series



EDP. No.	Dia.	L ₁	L ₂	D ₂	STOCK
ZE714 010	1.0	2.5	40	6	•
ZE714 012	1.2	3	40	6	•
ZE714 015	1.5	4	40	6	•
ZE714020	2.0	5	40	6	•
ZE714025	2.5	6	40	6	•
ZE714030	3.0	8	45	6	•
ZE714 035	3.5	9	45	6	•
ZE714040	4.0	10	45	6	•
ZE714050	5.0	13	50	6	•
ZE714060	6.0	13	50	6	•
ZE714 060-15		15	60		•
ZE714080	8.0	19	60	8	•
ZE714100	10.0	22	70	10	•
ZE714 100-25		25			•
ZE714120	12.0	26	75	12	•
ZE714 120-30		30	80		•

■ Tolerance

Mill Dia. (mm)	Shank Dia.
0 ~ -0.02	h6

※Items can be changed for quality improvement without notice.

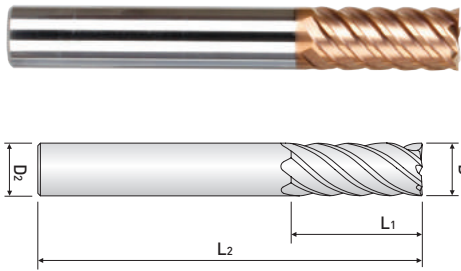

6 FLUTE, 50° HELIX REGULAR LENGTH

- Designed to machine high hardened materials up to HRc 70.
- Suitable for dry cutting & high speed cutting due to newly developed raw-material and new coating.

ZE716 ...series



EDP. No.	Dia.	L ₁	L ₂	D ₂	STOCK
ZE716060	6	13	50	6	•
ZE716080	8	18	60	8	•
ZE716100	10	22	70	10	•
ZE716120	12	26	75	12	•
ZE716160	16	35	90	16	•
ZE716200	20	44	100	20	•

■ Tolerance

Mill Dia. (mm)	Shank Dia.
0 ~ -0,02	h6

※Items can be changed for quality improvement without notice.











Neo Classic X-STAR Series















Neo Classic X-STAR Series



EDP. No.	APPEARANCE	FEATURE	STOCK	PAGE
XE505A ... series		5 FLUTES, STUB CUT LENGTH	•	93
XE515A ... series		5 FLUTES, REGULAR CUT LENGTH	•	94
XR505A ... series		5 FLUTES, STUB CUT LENGTH CORNER RADIUS	•	95
XR515A ... series		5 FLUTES, REGULAR CUT LENGTH CORNER RADIUS	•	96
XR525A ... series		5 FLUTES, REGULAR CUT LENGTH WITH EXTENDED NECK	•	97
XR535A ...series		5 FLUTES, REGULAR CUT LENGTH WITH LONG EXTENDED NECK	•	98
XE505 ... series		5 FLUTES, REGULAR CUT LENGTH	•	99
XE515 ... series		5 FLUTES, LONG CUT LENGTH	•	100
XR505 ... series		5 FLUTES, REGULAR CUT LENGTH CORNER RADIUS	•	101
XXB504 ...series		4 FLUTE, REGULAR LENGTH, BALL NOSE	•	102
XCE504 ...series		4 FLUTE, REGULAR LENGTH	•	103

Neo Classic X-STAR Series



EDP. No.	APPEARANCE	FEATURE	STOCK	PAGE
XCC504 ...series		4 FLUTE, REGULAR LENGTH	•	104
XCR504 ...series		4 FLUTE, REGULAR LENGTH	•	105
XCE503 ...series		3 FLUTE, REGULAR LENGTH	•	106
XCC503 ...series		3 FLUTE, REGULAR LENGTH	•	107
XCR503 ...series		3 FLUTE, REGULAR LENGTH	•	108
XE504 ...series		4 FLUTE, REGULAR LENGTH	•	109
XR504 ...series		4 FLUTE, REGULAR LENGTH	•	110
XE514 ...series		4 FLUTE, STUB CUT LENGTH with EXTENDED NECK	•	111
XE524 ...series		4 FLUTE, STUB CUT LENGTH with EXTENDED LONG NECK	•	112
XR514 ...series		4 FLUTE, REGULAR LENGTH	•	113

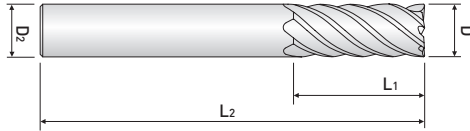

5 FLUTES, STUB CUT LENGTH

- Maintains Cutting Edge Strength & Sharpness for Improved Tool Life
- Strong Cutting Edges Allowing for Increased depths of cut at Elevated Cutting Speeds & Feeds
- Higher Feeds and Speeds for increased Productivity. Reduced Vibration Harmonics.

XE505A ... series

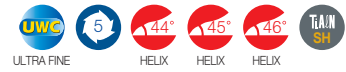

EDP. No.	D	L ₁	L ₂	D ₂	STOCK
XE505 A 016	1/4	3/8	2	1/4	•
XE505 A 020	5/16	7/16	2	5/16	•
XE505 A 024	3/8	1/2	2	3/8	•
XE505 A 028	7/16	9/16	2-1/2	7/16	•
XE505 A 032	1/2	5/8	2-1/2	1/2	•
XE505 A 040	5/8	3/4	3	5/8	•
XE505 A 048	3/4	1	3	3/4	•
XE505 A 064	1	1	4	1	•

■ Tolerance

Mill Dia. (inch)		Shank Dia.
from 1/8 up to 1/4	0 ~ -.0012	-.0001 ~ -.0003
over 1/4 up to 3/8	0 ~ -.0016	
over 3/8 up to 1	0 ~ -.002	-.0001 ~ -.0004

※Items can be changed for quality improvement without notice.

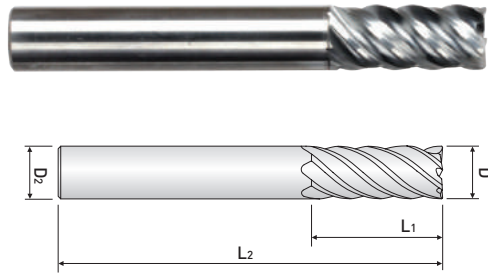

5 FLUTES, REGULAR CUT LENGTH

- Maintains Cutting Edge Strength & Sharpness for Improved Tool Life
- Strong Cutting Edges Allowing for Increased depths of cut at Elevated Cutting Speeds & Feeds
- Higher Feeds and Speeds for increased Productivity. Reduced Vibration Harmonics.

XE515A ... series

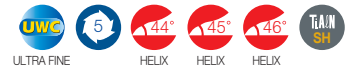

EDP. No.	D	L ₁	L ₂	D ₂	STOCK
XE515 A 016	1/4	5/8	2-1/2	1/4	•
XE515 A 018	9/32	5/8	2-1/2	5/16	•
XE515 A 020	5/16	13/16	2-1/2	5/16	•
XE515 A 022	11/32	13/16	2-1/2	3/8	•
XE515 A 024	3/8	7/8	2-1/2	3/8	•
XE515 A 026	13/32	7/8	2-3/4	7/16	•
XE515 A 028	7/16	1	2-3/4	7/16	•
XE515 A 030	15/32	1	3	1/2	•
XE515 A 032	1/2	1	3	1/2	•
XE515 A 036	9/16	1-1/8	3-1/2	9/16	•
XE515 A 040	5/8	1-1/4	3-1/2	5/8	•
XE515 A 048	3/4	1-1/2	4	3/4	•
XE515 A 064	1	1-1/2	4	1	•

■ Tolerance

Mill Dia. (inch)		Shank Dia.
from 1/8 up to 1/4	0 ~ -.0012	-.0001 ~ -.0003
over 1/4 up to 3/8	0 ~ -.0016	
over 3/8 up to 1	0 ~ -.002	-.0001 ~ -.0004

※Items can be changed for quality improvement without notice.

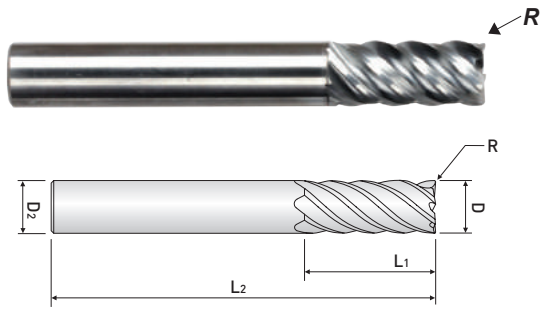

**5 FLUTES, STUB CUT LENGTH
CORNER RADIUS**

- Maintains Cutting Edge Strength & Sharpness for Improved Tool Life
- Strong Cutting Edges Allowing for Increased depths of cut at Elevated Cutting Speeds & Feeds
- Higher Feeds and Speeds for increased Productivity. Reduced Vibration Harmonics.

XR505A ... series

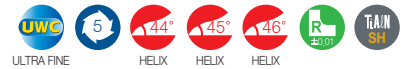

EDP. No.	D	R	L ₁	L ₂	D ₂	STOCK
XR505 A 016 015	1/4	.015	3/8	2	1/4	•
XR505 A 016 030		.030				•
XR505 A 020 015	5/16	.015	7/16	2	5/16	•
XR505 A 020 030		.030				•
XR505 A 024 015	3/8	.015	1/2	2	3/8	•
XR505 A 024 030		.030				•
XR505 A 028 015	7/16	.015	9/16	2-1/2	7/16	•
XR505 A 028 030		.030				•
XR505 A 032 015	1/2	.015	5/8	2-1/2	1/2	•
XR505 A 032 030		.030				•
XR505 A 040 015	5/8	.015	3/4	3	5/8	•
XR505 A 040 030		.030				•
XR505 A 040 045		.045				•
XR505 A 048 015	3/4	.015	1	3	3/4	•
XR505 A 048 030		.030				•
XR505 A 048 045		.045				•
XR505 A 064 015	1	.015	1-1/2	4	1	•
XR505 A 064 030		.030				•
XR505 A 064 045		.045				•
XR505 A 064 060		.060				•
XR505 A 064 090		.090				•
XR505 A 064 125		.125				•

■ Tolerance

Mill Dia. (inch)		Shank Dia.
from 1/8 up to 1/4	0 ~ -.0012	-.0001 ~ -.0003
over 1/4 up to 3/8	0 ~ -.0016	
over 3/8 up to 1	0 ~ -.002	-.0001 ~ -.0004

※Items can be changed for quality improvement without notice.

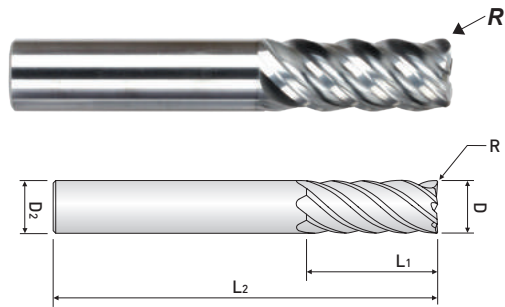

5 FLUTES, REGULAR CUT LENGTH CORNER RADIUS

- Maintains Cutting Edge Strength & Sharpness for Improved Tool Life
- Strong Cutting Edges Allowing for Increased depths of cut at Elevated Cutting Speeds & Feeds
- Higher Feeds and Speeds for increased Productivity. Reduced Vibration Harmonics.

XR515A ... series

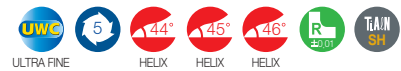

EDP. No.	D	R	L ₁	L ₂	D ₂	STOCK
XR515 A 016 015	1/4	.015	5/8	2-1/2	1/4	•
XR515 A 016 030		.030				•
XR515 A 018 015	9/32	.015	5/8	2-1/2	5/16	•
XR515 A 018 030		.030				•
XR515 A 020 015	5/16	.015	13/16	2-1/2	5/16	•
XR515 A 020 030		.030				•
XR515 A 022 015	11/32	.015	13/16	2-1/2	3/8	•
XR515 A 022 030		.030				•
XR515 A 024 015	3/8	.015	7/8	2-1/2	3/8	•
XR515 A 024 030		.030				•
XR515 A 026 015	13/32	.015	7/8	2-3/4	7/16	•
XR515 A 026 030		.030				•
XR515 A 028 015	7/16	.015	1	2-3/4	7/16	•
XR515 A 028 030		.030				•
XR515 A 030 015	15/32	.015	1	3	1/2	•
XR515 A 030 030		.030				•
XR515 A 032 015	1/2	.015	1	3	1/2	•
XR515 A 032 030		.030				•
XR515 A 032 045		.045				•
XR515 A 032 060		.060				•
XR515 A 032 090		.090				•
XR515 A 032 125		.125				•
XR515 A 036 015		9/16				.015
XR515 A 036 030	.030		•			
XR515 A 040 015	5/8	.015	1-1/4	3-1/2	5/8	•
XR515 A 040 030		.030				•
XR515 A 040 045		.045				•
XR515 A 040 060		.060				•
XR515 A 040 090		.090				•
XR515 A 040 125		.125				•
XR515 A 048 015	3/4	.015	1-1/2	4	3/4	•
XR515 A 048 030		.030				•
XR515 A 048 045		.045				•
XR515 A 048 060		.060				•
XR515 A 048 090		.090				•
XR515 A 048 125		.125				•

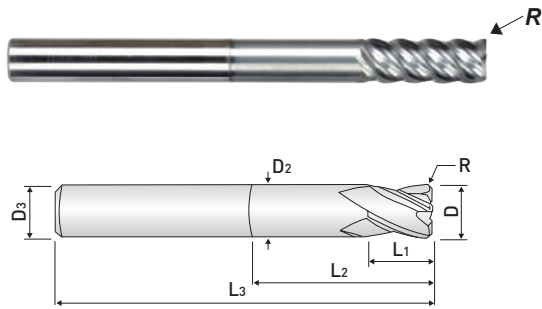

5 FLUTES, REGULAR CUT LENGTH WITH EXTENDED NECK

- Maintains Cutting Edge Strength & Sharpness for Improved Tool Life
- Strong Cutting Edges Allowing for Increased depths of cut at Elevated Cutting Speeds & Feeds
- Higher Feeds and Speeds for increased Productivity. Reduced Vibration Harmonics.

XR525A ... series

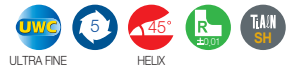

EDP. No.	D	R	L ₁	L ₂	L ₃	D ₂	D ₃	STOCK
XR525 A 016 015	1/4	.015	3/4	2-1/8	4	.242	1/4	•
XR525 A 016 030		.030						•
XR525 A 020 015	5/16	.015	1	2-1/8	4	.305	5/16	•
XR525 A 020 030		.030						•
XR525 A 024 015	3/8	.015	1	2-1/8	4	.367	3/8	•
XR525 A 024 030		.030						•
XR525 A 028 015	7/16	.015	-1/4	2-1/8	4	.430	7/16	•
XR525 A 028 030		.030						•
XR525 A 032 015	1/2	.015	1-1/4	2-1/8	4	.492	1/2	•
XR525 A 032 030		.030						•
XR525 A 032 015L		.015	1-3/8	3-1/8	5			•
XR525 A 032 030L		.030						•
XR525 A 040 015	5/8	.015	1-1/2	2-1/8	4	.617	5/8	•
XR525 A 040 030		.030						•
XR525 A 040 045		.045						•
XR525 A 040 015L		.015	1-3/4	3-1/8	5			•
XR525 A 040 030L		.030						•
XR525 A 040 045L		.045						•
XR525 A 048 015	3/4	.015	1-7/8	3	5	.742	3/4	•
XR525 A 048 030		.030						•
XR525 A 048 045		.045						•
XR525 A 064 015	1	.015	2-1/4	3	5	.992	1	•
XR525 A 064 030		.030						•
XR525 A 064 045		.045						•

■ Tolerance

Mill Dia. (inch)		Shank Dia.
from 1/8 up to 1/4	0 ~ -.0012	-.0001 ~ -.0003
over 1/4 up to 3/8	0 ~ -.0016	
over 3/8 up to 1	0 ~ -.002	

※Items can be changed for quality improvement without notice.

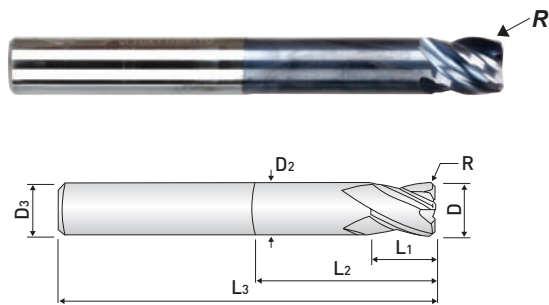

5 FLUTES, REGULAR CUT LENGTH WITH LONG EXTENDED NECK

- Maintains Cutting Edge Strength & Sharpness for Improved Tool Life
- Strong Cutting Edges Allowing for Increased depths of cut at Elevated Cutting Speeds & Feeds
- Higher Feeds and Speeds for increased Productivity. Reduced Vibration Harmonics.

XR535A ...series

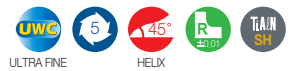

EDP. No.	D	R	L ₁	L ₂	L ₃	D ₂	D ₃	STOCK
XR535 A 024 015	3/8	.015	1-1/4	3-3/8	6	.367	3/8	•
XR535 A 024 030		.030						•
XR535 A 028 015	7/16	.015	1-1/2	3-3/8	6	.430	7/16	•
XR535 A 028 030		.030						•
XR535 A 032 015	1/2	.015	1-1/2	4-1/8	6	.492	1/2	•
XR535 A 032 030		.030						•
XR535 A 040 015	5/8	.015	2	4	6	.617	5/8	•
XR535 A 040 030		.030						•
XR535 A 040 045		.045						•
XR535 A 048 015	3/4	.015	2-1/4	4	6	.742	3/4	•
XR535 A 048 030		.030						•
XR535 A 048 045		.045						•
XR535 A 064 015	1	.015	3	4	6	.992	1	•
XR535 A 064 030		.030						•
XR535 A 064 045		.045						•

■ Tolerance

Mill Dia. (inch)		Shank Dia.
from 1/8 up to 1/4	0 ~ -.0012	-.0001 ~ -.0003
over 1/4 up to 3/8	0 ~ -.0016	
over 3/8 up to 1	0 ~ -.002	-.0001 ~ -.0004

※Items can be changed for quality improvement without notice.

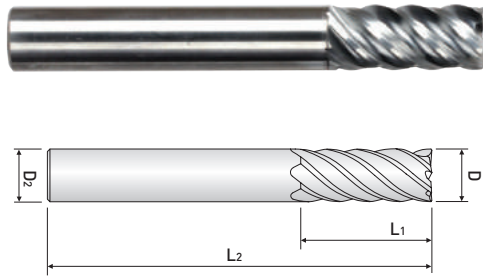

5 FLUTES, REGULAR CUT LENGTH

- Maintains Cutting Edge Strength & Sharpness for Improved Tool Life
- Strong Cutting Edges Allowing for Increased depths of cut at Elevated Cutting Speeds & Feeds
- Higher Feeds and Speeds for increased Productivity. Reduced Vibration Harmonics.

XE505 ... series

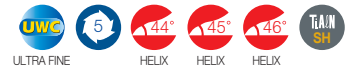

EDP. No.	D	L ₁	L ₂	D ₂	STOCK
XE505 060	6	13	57	6	•
XE505 080	8	19	63	8	•
XE505 100	10	22	72	10	•
XE505 120	12	26	83	12	•
XE505 140	14	26	83	14	•
XE505 160	16	32	92	16	•
XE505 180	18	32	92	18	•
XE505 200	20	38	104	20	•
XE505 250	25	38	104	25	•

■ Tolerance

Mill Dia. (mm)		Shank Dia.
Diameter	Tolerance	
up to 8	0 ~ -0,04	h6
over 8	0 ~ -0,05	

※Items can be changed for quality improvement without notice.

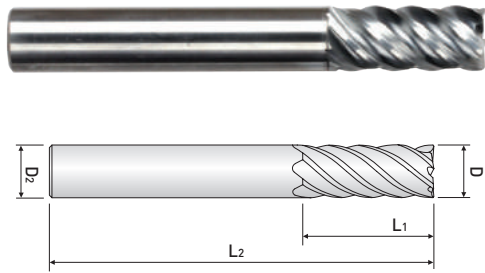

5 FLUTES, LONG CUT LENGTH

- Maintains Cutting Edge Strength & Sharpness for Improved Tool Life
- Strong Cutting Edges Allowing for Increased depths of cut at Elevated Cutting Speeds & Feeds
- Higher Feeds and Speeds for increased Productivity. Reduced Vibration Harmonics.

XE515 ... series



EDP. No.	D	L ₁	L ₂	D ₂	STOCK
XE515 060	6	25	75	6	•
XE515 080	8	30	75	8	•
XE515 100	10	45	100	10	•
XE515 120	12	75	150	12	•
XE515 160	16	75	150	16	•
XE515 200	20	75	150	20	•

■ Tolerance

Mill Dia, (mm)		Shank Dia, h6
Diameter	Tolerance	
up to 8	0 ~ -0.04	
over 8	0 ~ -0.05	

※Items can be changed for quality improvement without notice.

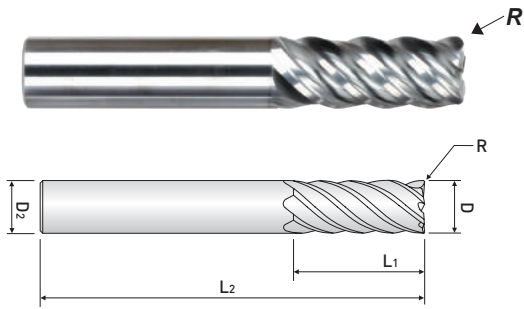

**5 FLUTES, REGULAR CUT LENGTH
CORNER RADIUS**

- Maintains Cutting Edge Strength & Sharpness for Improved Tool Life
- Strong Cutting Edges Allowing for Increased depths of cut at Elevated Cutting Speeds & Feeds
- Higher Feeds and Speeds for increased Productivity. Reduced Vibration Harmonics.

XR505 ... series

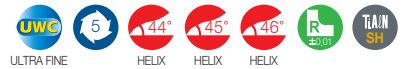

EDP. No.	D	R	L ₁	L ₂	D ₂	STOCK
XR505 06 050	6	0.5	13	57	6	•
XR505 08 050	8	0.5	19	63	8	•
XR505 10 050	10	0.5	22	72	10	•
XR505 12 075	12	0.75	26	83	12	•
XR505 14 075	14	0.75	26	83	14	•
XR505 14 075 S16				92	16	•
XR505 16 100	16	1.0	32	92	16	•
XR505 18 100	18	1.0	32	92	18	•
XR505 18 100 S20				104	20	•
XR505 20 100	20	1.0	38	104	20	•
XR505 25 100	25	1.0	38	104	25	•

■ Tolerance

Mill Dia. (mm)		Shank Dia.
Diameter	Tolerance	
up to 8	0 ~ -0,04	
over 8	0 ~ -0,05	

※ Items can be changed for quality improvement without notice.

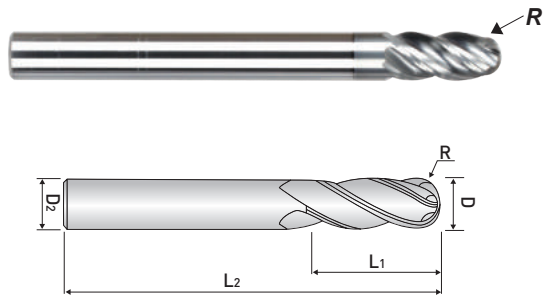

4 FLUTE, REGULAR LENGTH, BALL NOSE

- High precision and excellent surface due to each 4F broken index geometry
- The unique patented design decrease chatter and resonance.
- Strengthened cutting edge geometry designed for excellent performance on high-temp alloys, high tensile stainless steel, inconel and titanium.

XXB504 ...series

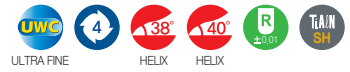

EDP. No.	D	R	L ₁	L ₂	D ₂	STOCK
XXB504040	4	2	8	70	4	•
XXB504060	6	3	12	90	6	•
XXB504080	8	4	15	100	8	•
XXB504100	10	5	20	100	10	•
XXB504120	12	6	25	110	12	•

※ Flat shank is available upon request
ex) XXB504100F : Flat shank

■ Tolerance

Mill Dia. (mm)	Shank Dia.
0 ~ -0.02	h6

※ Items can be changed for quality improvement without notice.

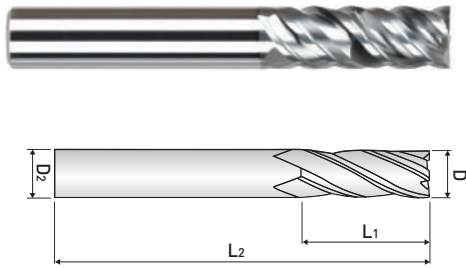

4 FLUTE, REGULAR LENGTH

- High precision and excellent surface due to each 4F broken index geometry
- The unique patented design decrease chatter and resonance, can achieve an Axial Depth 1XD
- Reinforced bending moment because of double core geometry

XCE504 ...series



EDP. No.	D	L ₁	L ₂	D ₂	STOCK
XCE504060	6	15	50	6	•
XCE504080	8	20	60	8	•
XCE504100	10	25	70	10	•
XCE504120	12	30	75	12	•
XCE504160	16	40	90	16	•
XCE504200	20	45	100	20	•
XCE504250	25	50	120	25	•

※ Flat shank is available upon request
ex) XCE504100F : Flat shank

■ Tolerance

Mill Dia, (mm)	Shank Dia,
0 ~ -0,02	h6

※Items can be changed for quality improvement without notice.

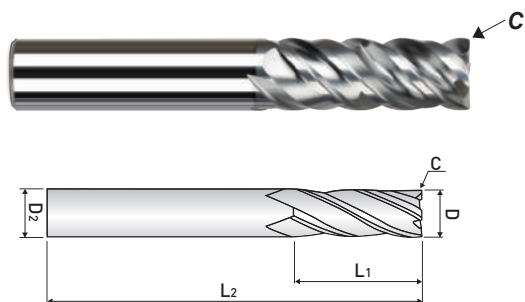

4 FLUTE, REGULAR LENGTH

- High precision and excellent surface due to each 4F broken index geometry
 - The unique patented design decrease chatter and resonance, can achieve an Axial Depth 1XD
 - Reinforced bending moment because of double core geometry
- * corner chamfer type

XCC504 ...series



EDP. No.	D	C	L ₁	L ₂	D ₂	STOCK
XCC504060	6	0.075	15	50	6	•
XCC504080	8	0.1	20	60	8	•
XCC504100	10	0.125	25	70	10	•
XCC504120	12	0.15	30	75	12	•
XCC504160	16	0.2	40	90	16	•
XCC504200	20	0.3	45	100	20	•
XCC504250	25	0.3	50	120	25	•

※ Flat shank is available upon request
ex) XCC504100F : Flat shank

■ Tolerance

Mill Dia. (mm)	Shank Dia.
0 ~ -0.02	h6

※ Items can be changed for quality improvement without notice.

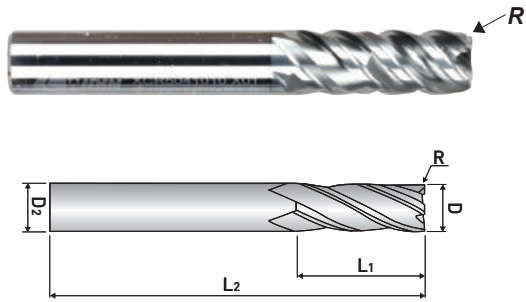

4 FLUTE, REGULAR LENGTH

- High precision and excellent surface due to each 4F broken index geometry
- The unique patented design decrease chatter and resonance, can achieve an Axial Depth 1XD
- Reinforced bending moment because of double core geometry

XCR504 ...series

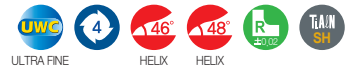

EDP. No.	D	R	L ₁	L ₂	D ₂	STOCK
XCR5040602	6	0.2	15	50	6	•
XCR5040605		0.5				•
XCR5040610		1				•
XCR5040805	8	0.5	20	60	8	•
XCR5040810		1				•
XCR5041005	10	0.5	25	70	10	•
XCR5041010		1				•
XCR5041205	12	0.5	30	75	12	•
XCR5041210		1				•
XCR5041605	16	0.5	40	90	16	•
XCR5041610		1				•
XCR5042005	20	0.5	45	100	20	•
XCR5042010		1				•
XCR5042505	25	0.5	50	120	25	•
XCR5042510		1				•

※ Flat shank is available upon request
ex) XCR5041010F : Flat shank

■ Tolerance

Mill Dia, (mm)	Shank Dia,
0 ~ -0,02	h6

※Items can be changed for quality improvement without notice.

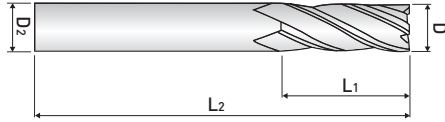

3 FLUTE, REGULAR LENGTH

- High precision and excellent surface due to each 4F broken index geometry
- The unique patented design decrease chatter and resonance, can achieve an Axial Depth 1XD
- Reinforced bending moment because of double core geometry

XCE503 ...series



EDP. No.	D	L ₁	L ₂	D ₂	STOCK
XCE503020	2	6	50	6	•
XCE503025	2.5	8	50	6	•
XCE503030	3	10	50	6	•
XCE503035	3.5	10	50	6	•
XCE503040	4	12	50	6	•
XCE503045	4.5	14	50	6	•
XCE503050	5	15	50	6	•
XCE503055	5.5	15	50	6	•
XCE503060	6	15	50	6	•
XCE503080	8	20	60	8	•
XCE503100	10	25	70	10	•
XCE503120	12	30	75	12	•
XCE503160	16	40	90	16	•
XCE503200	20	45	100	20	•
XCE503250	25	50	120	25	•

※ Flat shank is available upon request
ex) XCE503100F : Flat shank

■ Tolerance

Mill Dia. (mm)	Shank Dia.
0 ~ -0.02	h6

※ Items can be changed for quality improvement without notice.

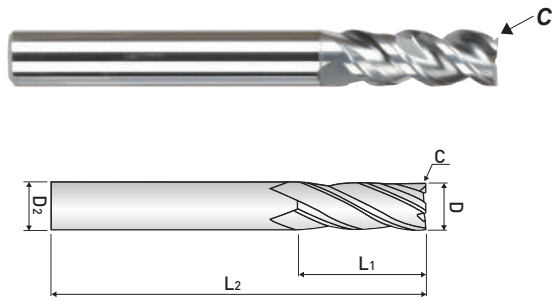

3 FLUTE, REGULAR LENGTH

- High precision and excellent surface due to each 4F broken index geometry
 - The unique patented design decrease chatter and resonance, can achieve an Axial Depth 1XD
 - Reinforced bending moment because of double core geometry
- * corner chamfer type

XCC503 ...series

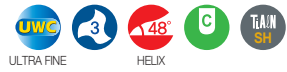

EDP. No.	D	C	L ₁	L ₂	D ₂	STOCK
XCC503020	2	0.025	6	50	6	•
XCC503025	2.5	0.025	8	50	6	•
XCC503030	3	0.035	10	50	6	•
XCC503035	3.5	0.035	10	50	6	•
XCC503040	4	0.045	12	50	6	•
XCC503045	4.5	0.045	14	50	6	•
XCC503050	5	0.055	15	50	6	•
XCC503055	5.5	0.055	15	50	6	•
XCC503060	6	0.075	15	50	6	•
XCC503080	8	0.1	20	60	8	•
XCC503100	10	0.125	25	70	10	•
XCC503120	12	0.150	30	75	12	•
XCC503160	16	0.200	40	90	16	•
XCC503200	20	0.250	45	100	20	•
XCC503250	25	0.300	50	120	25	•

※ Flat shank is available upon request
ex) XCC503100F : Flat shank

■ Tolerance

Mill Dia, (mm)	Shank Dia,
0 ~ -0,02	h6

※Items can be changed for quality improvement without notice.

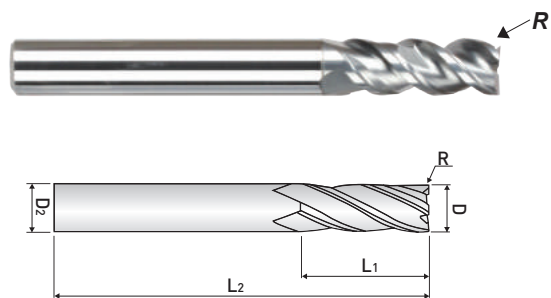

3 FLUTE, REGULAR LENGTH

- High precision and excellent surface due to each 4F broken index geometry
- The unique patented design decrease chatter and resonance, can achieve an Axial Depth 1XD
- Reinforced bending moment because of double core geometry

XCR503 ...series



EDP. No.	D	R	L ₁	L ₂	D ₂	STOCK
XCR5030502	5	0.2	15	50	6	•
XCR5030602	6	0.2	15	50	6	•
XCR5030605		0.5				•
XCR5030610		1				•
XCR5030805	8	0.5	20	60	8	•
XCR5030810		1				•
XCR5031005	10	0.5	25	70	10	•
XCR5031010		1				•
XCR5031205	12	0.5	30	75	12	•
XCR5031210		1				•
XCR5031605	16	0.5	40	90	16	•
XCR5031610		1				•
XCR5032005	20	0.5	45	100	20	•
XCR5032010		1				•
XCR5032505	25	0.5	50	120	25	•
XCR5032510		1				•

※ Flat shank is available upon request
ex) XCR5031010F : Flat shank

■ Tolerance

Mill Dia. (mm)	Shank Dia.
0 ~ -0.02	h6

※ Items can be changed for quality improvement without notice.

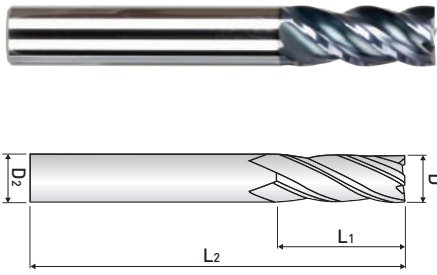

4 FLUTE, REGULAR LENGTH

- High precision and excellent surface due to each 4F broken index geometry
- The unique patented design decrease chatter and resonance, can achieve an Axial Depth 1XD
- Sharp cutting edge geometry designed for excellent performance on mild mold steel and stainless steel

XE504 ...series



EDP. No.	D	L ₁	L ₂	D ₂	STOCK
XE504010	1	2.5	45	4	•
XE504020	2	5	45	4	•
XE504030	3	8	50	6	•
XE504040	4	11	50	6	•
XE504050	5	13	50	6	•
XE504060	6	13	50	6	•
XE504070	7	16	60	8	•
XE504080	8	19	60	8	•
XE504090	9	19	70	10	•
XE504100	10	22	70	10	•
XE504110	11	22	75	12	•
XE504120	12	26	75	12	•
XE504130	13	26	80	12	•
XE504140	14	26	80	14	•
XE504160	16	32	90	16	•
XE504180	18	32	100	18	•
XE504200	20	38	100	20	•
XE504250	25	45	120	25	•

※ Flat shank is available upon request
ex) XE504100F : Flat shank

■ Tolerance

Mill Dia. (mm)		Shank Dia.
Diameter	Tolerance	
up to 12	0 ~ -0,02	h6
over 12	0 ~ -0,03	

※Items can be changed for quality improvement without notice.

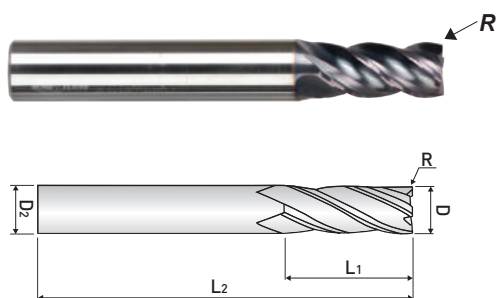

4 FLUTE, REGULAR LENGTH

- High precision and excellent surface due to each 4F broken index geometry
- The unique patented design decrease chatter and resonance, can achieve an Axial Depth 1XD
- Sharp cutting edge geometry designed for excellent performance on mild mold steel and stainless steel

XR504 ...series



EDP. No.	D	R	L ₁	L ₂	D ₂	STOCK
XR504020	2	0.1	5	45	4	•
XR504030	3	0.1	8	50	6	•
XR504040	4	0.2	11	50	6	•
XR504050	5	0.2	13	50	6	•
XR504060	6	0.2	13	50	6	•
XR504070	7	0.2	16	60	8	•
XR504080	8	0.2	19	60	8	•
XR504090	9	0.2	19	70	10	•
XR504100	10	0.3	22	70	10	•
XR504110	11	0.3	22	75	12	•
XR504120	12	0.3	26	75	12	•
XR504130	13	0.3	26	80	12	•
XR504140	14	0.3	26	80	14	•
XR504160	16	0.3	32	90	16	•
XR504180	18	0.3	32	100	18	•
XR504200	20	0.3	38	100	20	•
XR504250	25	0.3	45	120	25	•

※ Flat shank is available upon request
ex) XR504100F : Flat shank

■ Tolerance

Mill Dia. (mm)		Shank Dia.
Diameter	Tolerance	
up to 12	0 ~ -0,02	h6
over 12	0 ~ -0,03	

※ Items can be changed for quality improvement without notice.

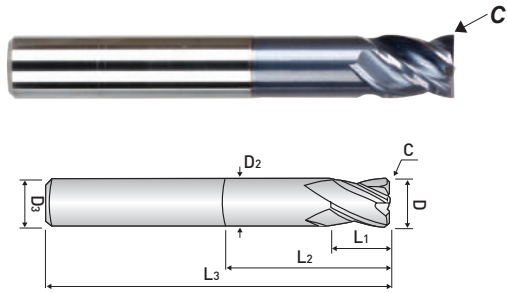

4 FLUTE, STUB CUT LENGTH with EXTENDED NECK

- High precision and excellent surface due to each 4F broken index geometry
- The unique patented design decrease chatter and resonance, can achieve an Axial Depth 1XD
- Sharp cutting edge geometry designed for excellent performance on mild mold steel and stainless steel
- * corner chamfer type

XE514 ...series

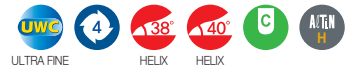

EDP. No.	D	L ₁	L ₂	L ₃	D ₂	D ₃	STOCK
XE514010	1	2	10	45	0.8	4	•
XE514020	2	3	12	45	1.8	4	•
XE514030	3	4	14	50	2.8	6	•
XE514040	4	5	16	50	3.8	6	•
XE514050	5	6	18	50	4.8	6	•
XE514060	6	7	20	50	5.8	6	•
XE514080	8	9	26	60	7.8	8	•
XE514100	10	11	31	70	9.8	10	•
XE514120	12	13	37	75	11.8	12	•
XE514160	16	17	43	90	15.8	16	•
XE514200	20	21	53	100	19.8	20	•

※ Flat shank is available upon request
ex) XE514100F : Flat shank

■ Tolerance

Mill Dia. (mm)		Shank Dia.
Diameter	Tolerance	
up to 12	0 ~ -0.02	h6
over 12	0 ~ -0.03	

※Items can be changed for quality improvement without notice.

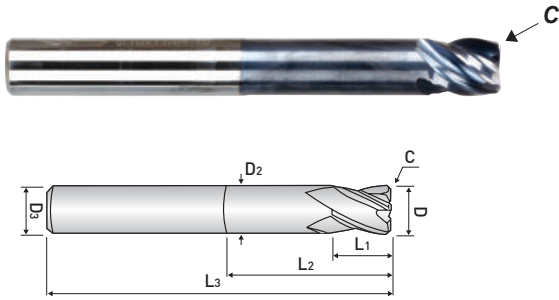

**4 FLUTE, STUB CUT LENGTH
with EXTENDED LONG NECK**

- High precision and excellent surface due to each 4F broken index geometry
 - The unique patented design decrease chatter and resonance, can achieve an Axial Depth 1XD
 - Sharp cutting edge geometry designed for excellent performance on mild mold steel and stainless steel
- * corner chamfer type

XE524 ...series

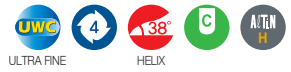

EDP. No.	D	L ₁	L ₂	L ₃	D ₂	D ₃	STOCK
XE524060	6	7	33	70	5.8	6	•
XE524080	8	9	43	80	7.8	8	•
XE524100	10	11	43	84	9.8	10	•
XE524120	12	13	51	97	11.8	12	•
XE524160	16	17	66	115	15.8	16	•

※ Flat shank is available upon request
ex) XE524100F : Flat shank

■ Tolerance

Mill Dia. (mm)		Shank Dia.
Diameter	Tolerance	
up to 12	0 ~ -0,02	h6
over 12	0 ~ -0,03	

※ Items can be changed for quality improvement without notice.

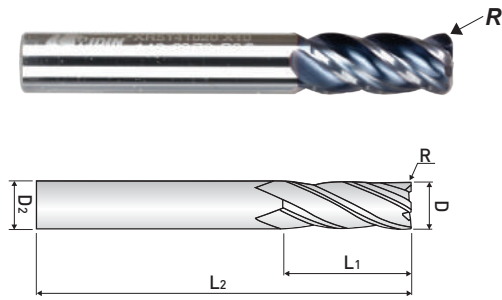

4 FLUTE, REGULAR LENGTH

- High precision and excellent surface due to each 4F broken index geometry
- The unique patented design decrease chatter and resonance, can achieve an Axial Depth 1XD
- Applied various corner radius.
- Sharp cutting edge geometry designed for excellent performance on mild mold steel and stainless steel

XR514 ...series

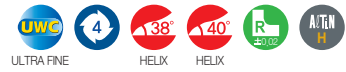

EDP. No.	D	R	L ₁	L ₂	D ₂	STOCK
XR5140201	2	0.1	5	45	4	•
XR5140202		0.2				•
XR5140302	3	0.2	8	50	6	•
XR5140303		0.3				•
XR5140305		0.5				•
XR5140403	4	0.3	10	50	6	•
XR5140405		0.5				•
XR5140410		1.0				•
XR5140505	5	0.5	13	50	6	•
XR5140510		1.0				•
XR5140605	6	0.5	13	50	6	•
XR5140610		1.0				•
XR5140615		1.5				•
XR5140805	8	0.5	19	60	8	•
XR5140810		1.0				•
XR5140815		1.5				•
XR5140820		2.0				•
XR5141005	10	0.5	22	70	10	•
XR5141010		1.0				•
XR5141015		1.5				•
XR5141020		2.0				•
XR5141205	12	0.5	26	75	12	•
XR5141210		1.0				•
XR5141215		1.5				•
XR5141220		2.0				•
XR5141230		3.0				•
XR5141615	16	1.5	32	90	16	•
XR5141620		2.0				•
XR5141630		3.0				•
XR5142030	20	3.0	38	100	20	•
XR5142040		4.0				•
XR5142050		5.0				•

※ Flat shank is available upon request ex) XR514100F : Flat shank

■ Tolerance

Mill Dia. (mm)		Shank Dia.
Diameter	Tolerance	
up to 12	0 ~ -0,02	h6
over 12	0 ~ -0,03	

※Items can be changed for quality improvement without notice.

Zamus Classic Series







Zamus Classic Series

WIDIN

EDP. No.	APPEARANCE	FEATURE	STOCK	PAGE
DB402 ...series		2 FLUTE, SHORT LENGTH, BALL NOSE	•	118
DB412 ...series		2 FLUTE, 15° HELIX STUB CUT LENGTH, BALL NOSE with EXTENDED NECK	•	119
DB512 ...series		2 FLUTE, LONG LENGTH, BALL NOSE	•	120
DB514 ...series		4 FLUTE, LONG LENGTH, BALL NOSE	•	121
DB502 ...series		2 FLUTE, STUB CUT LENGTH, BALL NOSE with EXTENDED NECK	•	122
DB522 ...series		2 FLUTE, EXTENDED NECK-LONG SHANK	•	123
DB532 ...series		2 FLUTE, MMC-SPHERE TYPE	•	124
DB534 ...series		4 FLUTE, MMC-SPHERE TYPE	•	125
DB54(5)2 ...series		2 FLUTE, BALL NOSE with TAPER NECK	•	126
ZE502 ...series		2 FLUTE, REGULAR LENGTH	•	127
ZE504 ...series		4 FLUTE, REGULAR LENGTH	•	128
ZE503 ...series		3 FLUTE, REGULAR LENGTH	•	129
ZE506 ...series		6 FLUTE, REGULAR & LONG LENGTH	•	130
ZM502 ...series		2 FLUTE, MEDIUM LENGTH	•	131
ZM504 ...series		4 FLUTE, MEDIUM LENGTH	•	132
ZM522 ...series		2 FLUTE, MEDIUM CUT, LONG SHANK TYPE	•	133
ZM524 ...series		4 FLUTE, MEDIUM CUT, LONG SHANK TYPE	•	134

Zamus Classic Series



EDP. No.	APPEARANCE	FEATURE	STOCK	PAGE
ZE522 ...series		2 FLUTE, LONG LENGTH	•	135
ZE524 ...series		4 FLUTE, LONG LENGTH	•	136
ZE534 ...series		4 FLUTE, EXTRA LONG LENGTH	•	137
ZE512 ...series		2 FLUTE 35° HELIX REGULAR LENGTH	•	138
ZE514 ...series		4 FLUTE 45° HELIX REGULAR LENGTH	•	139
ZE516 ...series		6 FLUTE 50° HELIX REGULAR LENGTH	•	140
ZE612 ...series		2 FLUTE, for RIB PROCESSING	•	141
DB612 ...series		2 FLUTE, for RIB PROCESSING	•	145
ZR502 ...series		2 FLUTE, STUB CUT LENGTH, CORNER RADIUS with EXTENDED NECK	•	149
ZR504 ...series		4 FLUTE, STUB CUT LENGTH, CORNER RADIUS with EXTENDED NECK	•	150
ZR512 ...series		2 FLUTE, REGULAR LENGTH, CORNER RADIUS	•	151
ZR514 ...series		4 FLUTE, REGULAR LENGTH, CORNER RADIUS	•	152
ZR522 ...series		2 FLUTE, LONG LENGTH, CORNER RADIUS	•	153
ZR524 ...series		4 FLUTE, LONG LENGTH, CORNER RADIUS	•	154
TPRB4 ...-050 series		MULTIPLE FLUTES - TAPER BALL ENDMILLS for RIB PROCESSING		155
TPRB4 ...-075 series		MULTIPLE FLUTES - TAPER BALL ENDMILLS for RIB PROCESSING		156

Zamus Classic Series



EDP. No.	APPEARANCE	FEATURE	STOCK	PAGE
TPRB4 ...-100 series		MULTIPLE FLUTES - TAPER BALL ENDMILLS for RIB PROCESSING		157
TPRB4 ...-150 series		MULTIPLE FLUTES - TAPER BALL ENDMILLS for RIB PROCESSING		159
TPRB4 ...-200 series		MULTIPLE FLUTES - TAPER BALL ENDMILLS for RIB PROCESSING		161
TPRE4 ...-050 series		MULTIPLE FLUTES - TAPER ENDMILLS for RIB PROCESSING		163
TPRE4 ...-075 series		MULTIPLE FLUTES - TAPER ENDMILLS for RIB PROCESSING		165
TPRE4 ...-100 series		MULTIPLE FLUTES - TAPER ENDMILLS for RIB PROCESSING		167
TPRE4 ...-150 series		MULTIPLE FLUTES - TAPER ENDMILLS for RIB PROCESSING		169
TPRE4 ...-200 series		MULTIPLE FLUTES - TAPER ENDMILLS for RIB PROCESSING		171
TPRE4 ...-300 series		MULTIPLE FLUTES - TAPER ENDMILLS for RIB PROCESSING		173
TE503series		3 FLUTE, TAPER END MILL		174
TB503 ...series		3 FLUTE, TAPER BALL END MILL		175
TB504 ...series		4 FLUTE, TAPER BALL END MILL		176
ZF60series		ROUGHING END MILL	•	177
ZF61 ...series		ROUGHING END MILL - FINE PITCH	•	178
PK503 ...series		Z - AXIS ROUGHING END MILL	•	179

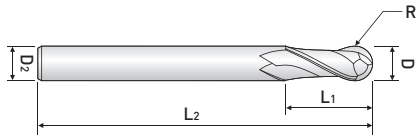

2 FLUTE, SHORT LENGTH, BALL NOSE

- Designed to machine tool steel, alloy steel, mold steel and other high hardened materials.
- Suitable for copy milling.

DB402 ...series



EDP. No.	Dia.	R	L ₁	L ₂	D ₂	STOCK
DB402010	1	0.5	3	38	4	•
DB402012	1.2	0.6	3	38	4	•
DB402015	1.5	0.75	3	42	4	•
DB402020	2	1	3	42	6	•
DB402025	2.5	1.25	3	42	6	•
DB402030	3	1.5	4	50	6	•
DB402035	3.5	1.75	4	50	6	•
DB402040	4	2	5	50	6	•
DB402045	4.5	2.25	5	50	6	•
DB402050	5	2.5	6	50	6	•
DB402055	5.5	2.75	6	50	6	•
DB402060	6	3	7	50	6	•
DB402070	7	3.5	8	60	8	•
DB402080	8	4	9	60	8	•
DB402090	9	4.5	10	70	10	•
DB402100	10	5	11	70	10	•
DB402120	12	6	12	75	12	•
DB402140	14	7	14	80	14	•
DB402160	16	8	16	82	16	•
DB402200	20	10	20	100	20	•

■ Tolerance

Mill Dia. (mm)	Shank Dia.
0 ~ -0.02	h6

※Items can be changed for quality improvement without notice.

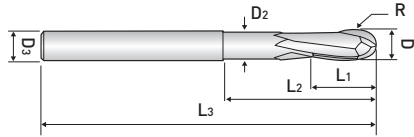

2 FLUTE, 15° HELIX STUB CUT LENGTH,
BALL NOSE with EXTENDED NECK

- Designed for high hardened materials up to HRC 62.
- Suitable for high speed machining.

DB412 ...series



EDP. No.	D	R	L ₁	L ₂	L ₃	D ₂	D ₃	STOCK
DB412010	1	0.5	1	3	50	0.95	4	•
DB412015	1.5	0.75	2	5	50	1.4	4	•
DB412020	2	1	3	6	50	1.9	6	•
DB412030S	3	1.5	4	8	50	2.9	4	•
DB412030					75		6	•
DB412030L								•
DB412040S	4	2	5	10	50	3.9	4	•
DB412040					75		6	•
DB412040L								•
DB412050	5	2.5	5	10	50	4.9	6	•
DB412060S	6	3	6	12	50	5.9	6	•
DB412060				75	6			•
DB412060L				16	100			•
DB412080	8	4	8	16	60	7.9	8	•
DB412080L				25	100			•
DB412100	10	5	10	20	70	9.9	10	•
DB412100L				30	100			•

■ Tolerance

Mill Dia. (mm)	Shank Dia.
0 ~ -0,03	h6

※Items can be changed for quality improvement without notice.

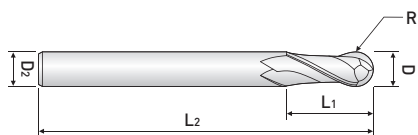

2 FLUTE, LONG LENGTH, BALL NOSE

- Designed to machine tool steel, alloy steel, mold steel and other high hardened materials.
- Suitable for copy milling.

DB512 ...series



EDP. No.	Dia.	R	L ₁	L ₂	D ₂	STOCK
DB512010	1	0.5	3	50	4	•
DB512010					6	•
DB512015	1.5	0.75	4	50	6	•
DB512020	2	1	5	60	4	•
DB512020					6	•
DB512025	2.5	1.25	6	60	6	•
DB512030	3	1.5	8	70	4	•
DB512030					6	•
DB512035	3.5	1.75	8	70	6	•
DB512040	4	2	8	70	4	•
DB512040					6	•
DB512045	4.5	2.25	10	70	6	•
DB512050	5	2.5	12	80	6	•
DB512055	5.5	2.75	12	80	6	•
DB512060	6	3	12	90	6	•
DB512065	6.5	3.25	12	90	8	•
DB512070	7	3.5	15	90	8	•
DB512080	8	4	15	100	8	•
DB512090	9	4.5	20	100	10	•
DB512100	10	5	20	100	10	•
DB512101			25	150		•
DB512110	11	5.5	25	110	12	•
DB512120	12	6	25	110	12	•
DB512121			30	150		•
DB512122			35	200		•
DB512130	13	6.5	30	110	14	•
DB512140	14	7	30	110	14	•
DB512150	15	7.5	35	140	16	•
DB512160	16	8	35	140	16	•
DB512161			40	200		•
DB512162			45	250		•
DB512180	18	9	40	150	18	•
DB512200	20	10	40	160	20	•
DB512201			45	200		•
DB512202			50	250		•
DB512250	25	12.5	50	180	25	•

■ Tolerance

Mill Dia. (mm)	Shank Dia.
0 ~ -0.02	h6

※Items can be changed for quality improvement without notice.

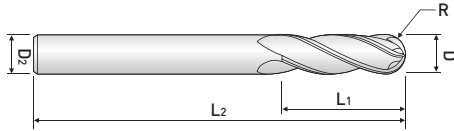

4 FLUTE, LONG LENGTH, BALL NOSE

- Designed to machine tool steel, alloy steel, mold steel and other high hardened materials.
- Suitable for copy milling.

DB514 ...series



EDP. No.	Dia.	R	L ₁	L ₂	D ₂	STOCK
DB514030	3	1.5	8	70	6	•
DB514040	4	2	8	70	6	•
DB514050	5	2.5	10	80	6	•
DB514060	6	3	12	90	6	•
DB514070	7	3.5	15	90	8	•
DB514080	8	4	15	100	8	•
DB514090	9	4.5	20	100	10	•
DB514100	10	5	20	100	10	•
DB514110	11	5.5	25	110	12	•
DB514120	12	6	25	110	12	•
DB514130	13	6.5	30	110	14	•
DB514140	14	7	30	110	14	•
DB514150	15	7.5	35	140	16	•
DB514160	16	8	35	140	16	•
DB514180	18	9	40	150	18	•
DB514200	20	10	40	160	20	•
DB514250	25	12.5	50	180	25	•

■ Tolerance

Mill Dia. (mm)	Shank Dia.
0 ~ -0,02	h6

※ Items can be changed for quality improvement without notice.

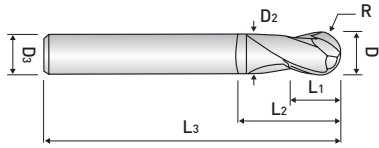

**2 FLUTE, STUB CUT LENGTH,
BALL NOSE with EXTENDED NECK**

- Designed to machine tool steel, alloy steel, mold steel and other high hardened materials.
- Suitable for copy milling.
- Designed to high strength.

DB502 ...series

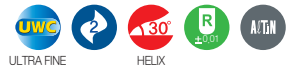

EDP. No.	D	R	L ₁	L ₂	L ₃	D ₂	D ₃	STOCK
DB502010	1	0.5	1	3	50	0.95	6	•
DB502015	1.5	0.75	1.5	4	50	1.45	6	•
DB502020	2	1	2	6	60	1.9	6	•
DB502030	3	1.5	4	9	70	2.85	6	•
DB502040	4	2	5	12	70	3.85	6	•
DB502050	5	2.5	6	15	80	4.7	6	•
DB502060	6	3	7	18	90	5.7	6	•
DB502080	8	4	10	24	90	7.7	8	•
DB502100	10	5	12	30	100	9.5	10	•
DB502120	12	6	14	36	110	11.5	12	•

■ Tolerance

Mill Dia. (mm)	Shank Dia.
0 ~ -0.02	h6

※Items can be changed for quality improvement without notice.

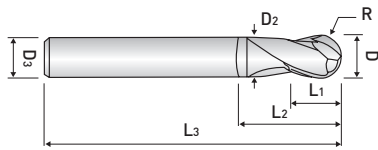

2 FLUTE, EXTENDED NECK-LONG SHANK

- Designed to machine tool steel, alloy steel, mold steel and other high hardened materials.
- Suitable for copy milling.
- Suitable for deep copy milling with long neck type.

DB522 ...series



EDP. No.	D	R	L ₁	L ₂	L ₃	D ₂	D ₃	STOCK
DB522030	3	1.5	4	35	100	2.9	6	•
DB522040	4	2	6	35	100	3.9	6	•
DB522050	5	2.5	7	40	115	4.9	6	•
DB522060	6	3	8	45	115	5.9	6	•
DB522061							8	•
DB522070	7	3.5	10	45	125	6.9	8	•
DB522080	8	4	12	55	125	7.9	8	•
DB522081							10	•
DB522090	9	4.5	15	65	140	8.9	10	•
DB522100	10	5	15	65	140	9.9	10	•
DB522120	12	6	18	75	150	11.9	12	•
DB522140	14	7	23	75	155	13.9	14	•
DB522160	16	8	30	75	155	15.9	16	•

■ Tolerance

Mill Dia. (mm)	Shank Dia.
0 ~ -0,02	h6

※Items can be changed for quality improvement without notice.

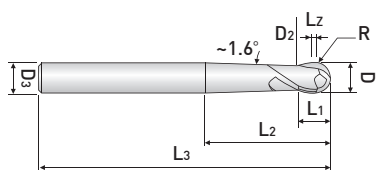

2 FLUTE, MMC-SPHERE TYPE

- For copy milling & steep sloped machining in mold & die.
- AlTiN coated for high wear resistance.

DB532 ...series



EDP. No.	D	R	L ₁	L ₂	L ₃	D ₂	D ₃	L _z	STOCK
DB532030	3	1.5	4	30	80	2.5	6	1.5	•
DB532031			2.3					-	
DB532040	4	2	5	30	80	3.3	6	1.5	•
DB532041			3.1					-	
DB532050	5	2.5	6	43	80	4.1	6	2	•
DB532051			3.9	38				-	
DB532060	6	3	7	30	100	4.7	6	2	•
DB532061			4.9	28				-	
DB532080	8	4	9	36	100	6.5	8	3	•
DB532081			6.3	33				-	
DB532100	10	5	11	43	100	8.2	10	3	•
DB532101			7.9	40				-	
DB532120	12	6	13	52	100	9.8	12	3	•
DB532121			9.5	49				-	
DB532160	16	8	15	61	150	13.4	16	3	•
DB532161			12.4	59				-	

■ Tolerance

Mill Dia. (mm)	Shank Dia.
0 ~ -0.02	h6

※Items can be changed for quality improvement without notice.

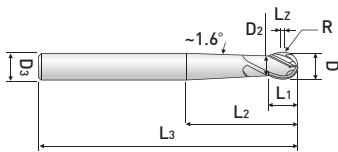

4 FLUTE, MMC-SPHERE TYPE

- For copy milling & Steep sloped machining in Mold & Die.
- AlTiN coated for high wear resistance.

DB534 ...series



EDP. No.	D	R	L ₁	L ₂	L ₃	D ₂	D ₃	L _z	STOCK
DB534050	5	2.5	6	43	80	4.1	6	2	•
DB534051			3.9	38				-	
DB534060	6	3	7	30	100	4.7	6	2	•
DB534061			4.9	28				-	
DB534080	8	4	9	36	100	6.5	8	3	•
DB534081			6.3	33				-	
DB534100	10	5	11	43	100	8.2	10	3	•
DB534101			7.9	40				-	
DB534120	12	6	13	52	100	9.8	12	3	•
DB534121			9.5	49				-	
DB534160	16	8	15	61	150	13.4	16	3	•
DB534161			12.4	59				-	

■ Tolerance

Mill Dia. (mm)	Shank Dia.
0 ~ -0,02	h6

※ Items can be changed for quality improvement without notice.

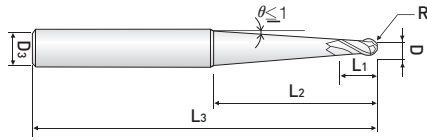

2 FLUTE, BALL NOSE with TAPER NECK

- Designed to machine tool steel, alloy steel, mold steel and other high hardened materials.
- Suitable for copy milling.
- Suitable for deep copy milling with taper long neck type.

DB54(5)2 ...series

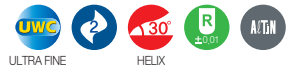

EDP. No.	D	R	L ₁	L ₂	L ₃	D ₃	STOCK
DB542020	2	1.0	3	63	110	6	•
DB552020			5	85	155		•
DB542030	3	1.5	5	65	110	6	•
DB552030			7	87	155		•
DB542040	4	2.0	7	67	110	6	•
DB552040			10	90	155	8	•
DB542050	5	2.5	10	70	110	6	•
DB552050			15	95	155	8	•
DB542060	6	3.0	18	78	155	10	•
DB552060			20	110	200		•
DB542080	8	4.0	30	100	155	12	•
DB552080				120	200		•
DB542100	10	5.0	40	100	155	12	•
DB552100				120	200		•
DB542120	12	6.0	50	110	155	16	•
DB552120				130	200		•

■ Tolerance

Mill Dia. (mm)	Shank Dia.
0 ~ -0.02	h6

※Items can be changed for quality improvement without notice.

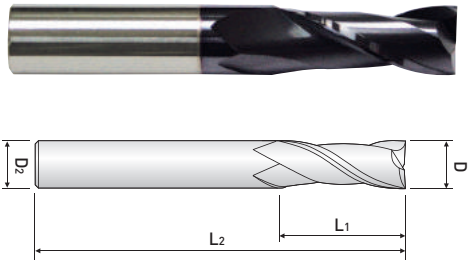

2 FLUTE, REGULAR LENGTH

- Designed to machine tool steel, alloy steel, mold steel and other high hardened materials.
- Superior workpiece finishes.

ZE502 ...series



EDP. No.	Dia.	L ₁	L ₂	D ₂	STOCK
ZE502010	1	3	42	4	•
ZE502010				6	•
ZE502015	1.5	4	42	6	•
ZE502020				4	•
ZE502020	2	6	42	6	•
ZE502025				6	•
ZE502025	2.5	8	42	6	•
ZE502030				4	•
ZE502030	3	10	50	6	•
ZE502035				6	•
ZE502040	4	12	50	4	•
ZE502040				6	•
ZE502045	4.5	14	50	6	•
ZE502050	5	15	50	6	•
ZE502055	5.5	15	50	6	•
ZE502060	6	15	50	6	•
ZE502065	6.5	18	60	8	•
ZE502070	7	20	60	8	•
ZE502075	7.5	20	60	8	•
ZE502080	8	20	60	8	•
ZE502085	8.5	23	70	10	•
ZE502090	9	25	70	10	•
ZE502095	9.5	25	70	10	•
ZE502100	10	25	70	10	•
ZE502105	10.5	28	75	12	•
ZE502110	11	30	75	12	•
ZE502115	11.5	30	75	12	•
ZE502120	12	30	75	12	•
ZE502125S12	12.5	30	80	12	•
ZE502130S12	13	30	80	12	•
ZE502130			85	14	•
ZE502130S16			90	16	•
ZE502140	14	35	85	14	•
ZE502140S16			90	16	•
ZE502150			90	16	•
ZE502160	15	40	90	16	•
ZE502170	16	40	90	16	•
ZE502170	17	40	100	16	•
ZE502180	18	45	100	18	•
ZE502190	19	45	100	20	•
ZE502200	20	45	100	20	•
ZE502220	22	45	100	20	•
ZE502240	24	50	120	25	•
ZE502250	25	50	120	25	•

■ Tolerance

Mill Dia, (mm)	Shank Dia,
0 ~ -0,02	h6

※Items can be changed for quality improvement without notice.

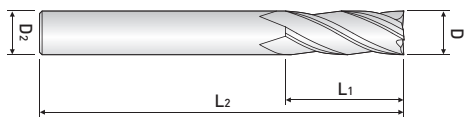

4 FLUTE, REGULAR LENGTH

- Designed to machine tool steel, alloy steel, mold steel and other high hardened materials.
- Superior workpiece finishes.

ZE504 ...series



EDP. No.	Dia.	L ₁	L ₂	D ₂	STOCK
ZE504010	1	2.5	42	6	•
ZE504015	1.5	4	42	6	•
ZE504020S4	2	6	42	4	•
ZE504020				6	•
ZE504025	2.5	8	42	6	•
ZE504030S4	3	10	50	4	•
ZE504030				6	•
ZE504035	3.5	10	50	6	•
ZE504040S4	4	12	50	4	•
ZE504040				6	•
ZE504045	4.5	14	50	6	•
ZE504050	5	15	50	6	•
ZE504055	5.5	15	50	6	•
ZE504060	6	15	50	6	•
ZE504065	6.5	18	60	8	•
ZE504070	7	20	60	8	•
ZE504075	7.5	20	60	8	•
ZE504080	8	20	60	8	•
ZE504085	8.5	23	70	10	•
ZE504090	9	25	70	10	•
ZE504095	9.5	25	70	10	•
ZE504100	10	25	70	10	•
ZE504105	10.5	28	75	12	•
ZE504110	11	30	75	12	•
ZE504115	11.5	30	75	12	•
ZE504120	12	30	75	12	•
ZE504125S12	12.5	30	80	12	•
ZE504130S12		30	80	12	•
ZE504130	13	35	85	14	•
ZE504130S16			90	16	•
ZE504140	14	35	85	14	•
ZE504140S16			90	16	•
ZE504150	15	40	90	16	•
ZE504160	16	40	90	16	•
ZE504170	17	40	100	16	•
ZE504180	18	45	100	18	•
ZE504190	19	45	100	20	•
ZE504200	20	45	100	20	•
ZE504220	22	45	100	20	•
ZE504240	24	50	120	25	•
ZE504250	25	50	120	25	•

■ Tolerance

Mill Dia. (mm)	Shank Dia.
0 ~ -0.02	h6

※Items can be changed for quality improvement without notice.

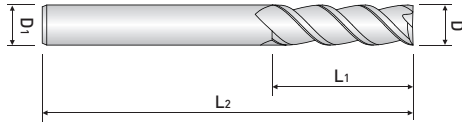

3 FLUTE, REGULAR LENGTH

- Designed to machine tool steel, alloy steel, mold steel and other high hardened materials.
- Superior workpiece finishes.

ZE503 ...series



EDP. No.	Dia.	L ₁	L ₂	D ₂	STOCK
ZE503060	6	15	50	6	•
ZE503070	7	18	60	8	•
ZE503080	8				•
ZE503090	9	22	70	10	•
ZE503100	10				•
ZE503110	11	26	75	12	•
ZE503120	12				•
ZE503130	13	32	85	14	•
ZE503140	14				•
ZE503150	15	35	90	16	•
ZE503160	16				•
ZE503180	18	40	100	18	•
ZE503200	20	40	100	20	•
ZE503250	25	50	120	25	•
ZE503320	32	70	150	32	•

■ Tolerance

Mill Dia. (mm)	Shank Dia.
0 ~ -0,03	h6

※ Items can be changed for quality improvement without notice.

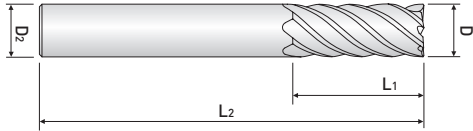

6 FLUTE, REGULAR & LONG LENGTH

- Designed for highly hardened materials up to HRc 55.
- Suitable for high speed & finishing machining.

ZE506 ...series



EDP. No.	Dia.	L ₁	L ₂	D ₂	STOCK
ZE506060	6	15	50	6	•
ZE506061		26	70		•
ZE506070	7	18	60	8	•
ZE506080	8	18	60	8	•
ZE506081		36	90		•
ZE506090	9	22	70	10	•
ZE506100	10	22	70	10	•
ZE506101		46	100		•
ZE506110	11	26	75	12	•
ZE506120	12	26	75	12	•
ZE506121		56	110		•
ZE506130	13	32	85	14	•
ZE506140	14	32	85	14	•
ZE506150	15	35	90	16	•
ZE506160	16	35	90	16	•
ZE506161		66	130		•
ZE506180	18	44	100	18	•
ZE506200	20	44	100	20	•
ZE506201		76	150		•
ZE506250	25	50	120	25	•
ZE506251		92	180		•
ZE506320	32	70	150	32	•

■ Tolerance

Mill Dia. (mm)	Shank Dia.
0 ~ -0,03	h6

※Items can be changed for quality improvement without notice.

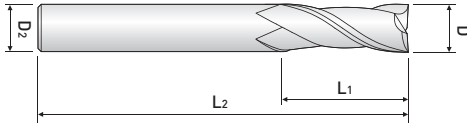

2 FLUTE, MEDIUM LENGTH

- Designed to machine tool steel, alloy steel, mold steel and other high hardened materials.
- Superior workpiece finishes.

ZM502 ...series



EDP. No.	Dia.	L ₁	L ₂	D ₂	STOCK
ZM502020	2	8	40	4	•
ZM502030	3	12	50	6	•
ZM502040	4	15	50	6	•
ZM502050	5	20	60	6	•
ZM502060	6	20	60	6	•
ZM502080	8	25	70	8	•
ZM502100	10	30	90	10	•
ZM502120	12	30	90	12	•
ZM502140	14	40	110	16	•
ZM502160	16	50	110	16	•
ZM502180	18	50	110	20	•
ZM502200	20	55	110	20	•
ZM502250	25	75	140	25	•

■ Tolerance

Mill Dia, (mm)	Shank Dia,
0 ~ -0,03	h6

※ Items can be changed for quality improvement without notice.

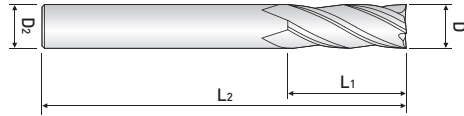

4 FLUTE, MEDIUM LENGTH

- Designed to machine tool steel, alloy steel, mold steel and other high hardened materials.
- Superior workpiece finishes.

ZM504 ...series



EDP. No.	Dia.	L ₁	L ₂	D ₂	STOCK
ZM504020	2	8	40	4	•
ZM504030	3	12	50	6	•
ZM504040	4	15	50	6	•
ZM504050	5	20	60	6	•
ZM504060	6	20	60	6	•
ZM504080	8	25	70	8	•
ZM504100	10	30	90	10	•
ZM504120	12	30	90	12	•
ZM504140	14	40	110	16	•
ZM504160	16	50	110	16	•
ZM504180	18	50	110	20	•
ZM504200	20	55	110	20	•
ZM504250	25	75	140	25	•

■ Tolerance

Mill Dia. (mm)	Shank Dia.
0 ~ -0,03	h6

※ Items can be changed for quality improvement without notice.

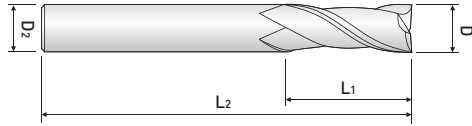

2 FLUTE, MEDIUM CUT LONG SHANK TYPE

- Designed to machine tool steel, alloy steel, mold steel and other high hardened materials.
- Superior workpiece finishes.

ZM522 ...series



EDP. No.	Dia.	L ₁	L ₂	D ₂	STOCK
ZM522030	3	10	70	6	•
ZM522040	4	12	70	6	•
ZM522050	5	15	80	6	•
ZM522060	6	15	80	6	•
ZM522080	8	20	100	8	•
ZM522100	10	25	100	10	•
ZM522120	12	30	110	12	•
ZM522160	16	40	125	16	•
ZM522200	20	45	150	20	•

■ Tolerance

Mill Dia, (mm)	Shank Dia,
0 ~ -0,03	h6

※ Items can be changed for quality improvement without notice.

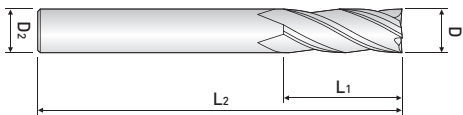

4 FLUTE, MEDIUM CUT LONG SHANK TYPE

- Designed to machine tool steel, alloy steel, mold steel and other high hardened materials.
- Superior workpiece finishes.

ZM524 ...series



EDP. No.	Dia.	L ₁	L ₂	D ₂	STOCK
ZM524030	3	10	70	6	•
ZM524040	4	12	70	6	•
ZM524050	5	15	80	6	•
ZM524060	6	15	80	6	•
ZM524080	8	20	100	8	•
ZM524100	10	25	100	10	•
ZM524120	12	30	110	12	•
ZM524160	16	40	125	16	•
ZM524200	20	45	150	20	•

■ Tolerance

Mill Dia. (mm)	Shank Dia.
0 ~ -0.03	h6

※Items can be changed for quality improvement without notice.

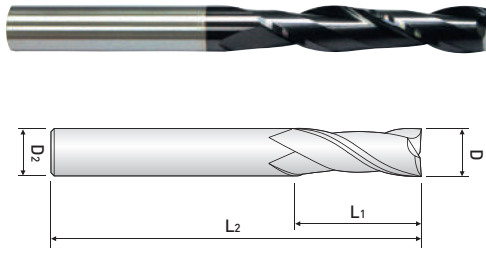

2 FLUTE, LONG LENGTH

- Designed to machine tool steel, alloy steel, mold steel and other high hardened materials.
- Superior workpiece finishes.

ZE522 ...series



EDP. No.	Dia.	L ₁	L ₂	D ₂	STOCK
ZE522030	3	25	75	6	•
ZE522040	4	25	75	6	•
ZE522050	5	30	80	6	•
ZE522060	6	30	80	6	•
ZE522070	7	35	85	8	•
ZE522080	8	35	85	8	•
ZE522090	9	45	100	10	•
ZE522100	10	45	100	10	•
ZE522101		60	155		•
ZE522110	11	50	110	12	•
ZE522120	12	55	120	12	•
ZE522121		65	155		•
ZE522140	14	60	120	14	•
ZE522160	16	60	120	16	•
ZE522161		75	165		•
ZE522180	18	60	120	18	•
ZE522200	20	60	120	20	•
ZE522201		75	165		•

■ Tolerance

Mill Dia. (mm)	Shank Dia.
0 ~ -0,03	h6

※ Items can be changed for quality improvement without notice.

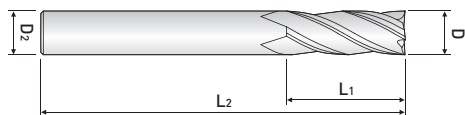

4 FLUTE, LONG LENGTH

- Designed to machine tool steel, alloy steel, mold steel and other high hardened materials.
- Superior workpiece finishes.

ZE524 ...series



EDP. No.	Dia.	L ₁	L ₂	D ₂	STOCK
ZE524030	3	25	75	6	•
ZE524040	4	25	75	6	•
ZE524050	5	30	80	6	•
ZE524060	6	30	80	6	•
ZE524070	7	35	85	8	•
ZE524080	8	35	85	8	•
ZE524090	9	45	100	10	•
ZE524100	10	45	100	10	•
ZE524110	11	50	110	12	•
ZE524120	12	55	120	12	•
ZE524140	14	60	120	14	•
ZE524160	16	60	120	16	•
ZE524180	18	60	120	18	•
ZE524200	20	60	120	20	•

■ Tolerance

Mill Dia. (mm)	Shank Dia.
0 ~ -0,03	h6

※ Items can be changed for quality improvement without notice.

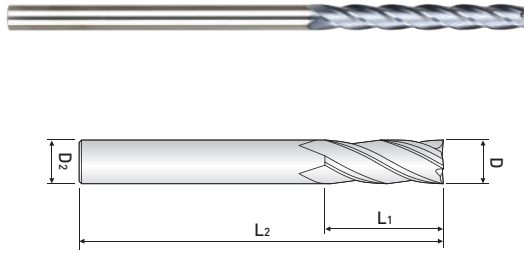

4 FLUTE, EXTRA LONG LENGTH

- Designed to machine tool steel, alloy steel, mold steel and other high hardened materials.
- Superior workpiece finishes.

ZE534 ...series



EDP. No.	Dia.	L ₁	L ₂	D ₂	STOCK
ZE534040	4	30	130	6	•
ZE534050	5	35	130	6	•
ZE534060	6	40	130	6	•
ZE534061		50	155		•
ZE534081	8	60	155	8	•
ZE534082		80	200		•
ZE534101	10	60	155	10	•
ZE534102		80	200		•
ZE534121	12	60	155	12	•
ZE534122		80	200		•
ZE534161	16	80	155	16	•
ZE534162		100	200		•
ZE534163		120	250		•
ZE534201	20	80	165	20	•
ZE534202		100	200		•
ZE534203		130	250		•
ZE534252	25	100	200	25	•
ZE534253		150	250		•

■ Tolerance

Mill Dia, (mm)	Shank Dia,
0 ~ -0,03	h6

※Items can be changed for quality improvement without notice.

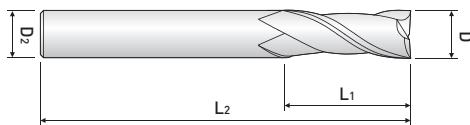

2 FLUTE, 35° HELIX REGULAR LENGTH

- Designed for high hardened materials up to HRc 62.
- Suitable for high speed machining.

ZE512 ...series



EDP. No.	Dia.	L ₁	L ₂	D ₂	STOCK
ZE512010	1	3	40	6	•
ZE512015	1.5	4	40	6	•
ZE512020	2	5	40	6	•
ZE512025	2.5	6	40	6	•
ZE512030	3	8	45	6	•
ZE512035	3.5	10	45	6	•
ZE512040	4	10	45	6	•
ZE512045	4.5	11	45	6	•
ZE512050	5	13	50	6	•
ZE512055	5.5	13	50	6	•
ZE512060	6	13	50	6	•
ZE512065	6.5	16	60	8	•
ZE512070	7	18	60	8	•
ZE512080	8	19	60	8	•
ZE512100	10	22	70	10	•
ZE512120	12	26	75	12	•

■ Tolerance

Mill Dia. (mm)	Shank Dia.
0 ~ -0,02	h6

※Items can be changed for quality improvement without notice.

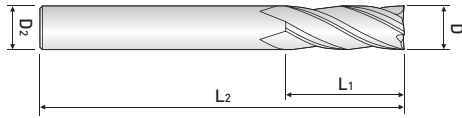

4 FLUTE, 45° HELIX REGULAR LENGTH

- Designed for high hardened materials up to HRc 62.
- Suitable for high speed machining.

ZE514 ...series



EDP. No.	Dia.	L ₁	L ₂	D ₂	STOCK
ZE514020	2	5	40	6	•
ZE514025	2.5	6	40	6	•
ZE514030	3	8	45	6	•
ZE514040	4	10	45	6	•
ZE514050	5	13	50	6	•
ZE514060	6	13	50	6	•
ZE514080	8	19	60	8	•
ZE514100	10	22	70	10	•
ZE514120	12	26	75	12	•

■ Tolerance

Mill Dia, (mm)	Shank Dia,
0 ~ -0,02	h6

※Items can be changed for quality improvement without notice.

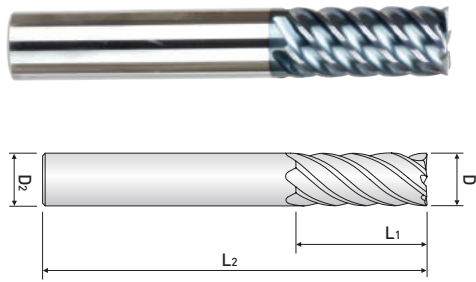

6 FLUTE, 50° HELIX REGULAR LENGTH

- Designed for high hardened materials up to HRc 62.
- Suitable for high speed machining.

ZE516 ...series



EDP. No.	Dia.	L ₁	L ₂	D ₂	STOCK
ZE516060	6	13	50	6	•
ZE516080	8	18	60	8	•
ZE516100	10	22	70	10	•
ZE516120	12	26	75	12	•
ZE516160	16	35	90	16	•
ZE516200	20	44	100	20	•

■ Tolerance

Mill Dia. (mm)	Shank Dia.
0 ~ -0,02	h6

※Items can be changed for quality improvement without notice.

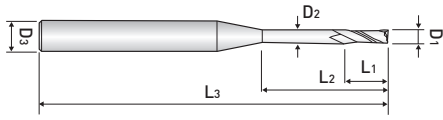

2 FLUTE, for RIB PROCESSING

- Designed for machine tool steel, alloy steel, mold steel and other high hardened materials.
- Long neck design for deep machining near walls.

ZE612 ...series



EDP. No.	D ₁	L ₁	L ₂	L ₃	D ₂	D ₃	STOCK
ZE6120402	0.4	0.6	2	45	0.37	4	•
ZE6120403			3				•
ZE6120404			4				•
ZE6120405			5				•
ZE6120406			6				•
ZE6120408			8				•
ZE6120502	0.5	0.7	2	45	0.45	4	•
ZE6120503			3				•
ZE6120504			4				•
ZE6120505			5				•
ZE6120506			6				•
ZE6120508			8				•
ZE6120510			10				•
ZE6120602	0.6	0.9	2	45	0.55	4	•
ZE6120603			3				•
ZE6120604			4				•
ZE6120605			5				•
ZE6120606			6				•
ZE6120608			8				•
ZE6120610			10				•
ZE6120612			12				•
ZE6120702	0.7	1	2	45	0.65	4	•
ZE6120704			4				•
ZE6120706			6				•
ZE6120708			8				•
ZE6120710			10				•
ZE6120802	0.8	1.2	2	45	0.75	4	•
ZE6120804			4				•
ZE6120806			6				•
ZE6120808			8				•
ZE6120810			10				•
ZE6120812			12				•
ZE6120906	0.9	1.4	6	45	0.85	4	•
ZE6120908			8				•
ZE6120910			10				•
ZE6121003	1	1.5	3	45	0.95	4	

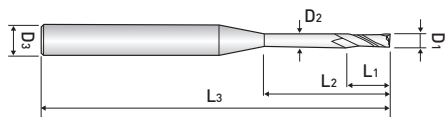

2 FLUTE, for RIB PROCESSING

- Designed for machine tool steel, alloy steel, mold steel and other high hardened materials.
- Long neck design for deep machining near walls.

ZE612 ...series



EDP. No.	D ₁	L ₁	L ₂	L ₃	D ₂	D ₃	STOCK
ZE6121004	1	1.5	4	45	0.95	4	•
ZE6121005			5				•
ZE6121006			6				•
ZE6121008			8				•
ZE6121010			10				•
ZE6121012			12				•
ZE6121014			14	•			
ZE6121016			16	50			•
ZE6121018			18				•
ZE6121020			20				•
ZE6121025			25	60			•
ZE6121206			1.2	1.8			6
ZE6121208	8	•					
ZE6121210	10	•					
ZE6121212	12	50			•		
ZE6121216	16				•		
ZE6121220	20				•		
ZE6121225	25				60	•	
ZE6121406	1.4	2.1	6	45	1.35	4	•
ZE6121408			8				•
ZE6121410			10				•
ZE6121412			12	50			•
ZE6121414			14				•
ZE6121416			16				•
ZE6121420			20				•
ZE6121506	1.5	2.3	6	45	1.45	4	•
ZE6121508			8				•
ZE6121510			10				•
ZE6121512			12				50
ZE6121514			14	•			
ZE6121516			16	•			
ZE6121518			18	55			•
ZE6121520			20				•
ZE6121525			25				60
ZE6121606			1.6	2.5			6
ZE6121608	8	•					

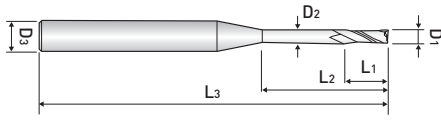

2 FLUTE, for RIB PROCESSING

- Designed for machine tool steel, alloy steel, mold steel and other high hardened materials.
- Long neck design for deep machining near walls.

ZE612 ...series



EDP. No.	D ₁	L ₁	L ₂	L ₃	D ₂	D ₃	STOCK
ZE6121610	1.6	2.5	10	45	1.55	4	•
ZE6121612			12				•
ZE6121614			14	50			•
ZE6121616			16				•
ZE6121618			18	55			•
ZE6121620			20				•
ZE6121806	1.8	2.8	6	45	1.75	4	•
ZE6121808			8				•
ZE6121810			10				•
ZE6121812			12				50
ZE6121814			14	•			
ZE6121816			16	55			•
ZE6121818			18				•
ZE6121820			20	•			
ZE6122006	2	3	6	45	1.95	4	•
ZE6122008			8				•
ZE6122010			10				•
ZE6122012			12				50
ZE6122014			14	•			
ZE6122016			16	55			•
ZE6122018			18				•
ZE6122020			20	60			•
ZE6122022			22				•
ZE6122025			25	70			•
ZE6122030			30				•
ZE6122035			35	80			•
ZE6122040			40				•
ZE6122508			2.5	3.7			8
ZE6122510	10	•					
ZE6122512	12	50			•		
ZE6122514	14				•		
ZE6122516	16	55			•		
ZE6122518	18				•		
ZE6122520	20	60			•		
ZE6122525	25				•		
ZE6122530	30	70			•		

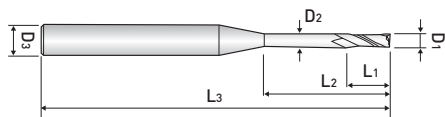

2 FLUTE, for RIB PROCESSING

- Designed for machine tool steel, alloy steel, mold steel and other high hardened materials.
- Long neck design for deep machining near walls.

ZE612 ...series



EDP. No.	D ₁	L ₁	L ₂	L ₃	D ₂	D ₃	STOCK
ZE6122535	2.5	3.7	35	70	2.45	4	•
ZE6122540			40	80			•
ZE6123008	3	4.5	8	45	2.85	6	•
ZE6123010			10				•
ZE6123012			12				•
ZE6123014			14	50			•
ZE6123016			16				•
ZE6123018			18	55			•
ZE6123020			20				•
ZE6123025			25	60			•
ZE6123030			30	70			•
ZE6123035			35	80			•
ZE6123040	40	90	•				
ZE6123045	45		•				
ZE6123050	50	100	•				
ZE6124010	4	6	10	50	3.85	6	•
ZE6124012			12				•
ZE6124016			16	60			•
ZE6124020			20				•
ZE6124025			25	70			•
ZE6124030			30				•
ZE6124035			35	80			•
ZE6124040			40	90			•
ZE6124045			45				•
ZE6124050			50	100			•
ZE6125016	5	7.5	16	60	4.85	6	•
ZE6125020			20				•
ZE6125025			25	70			•
ZE6125030			30				•
ZE6125035			35	80			•
ZE6125040			40	90			•
ZE6125045			45	100			•
ZE6125050			50				•

■ Tolerance

Mill Dia. (mm)	Shank Dia.
0 ~ -0.02	h6

※Items can be changed for quality improvement without notice.

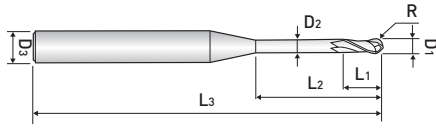

2 FLUTE, for RIB PROCESSING

- Designed for machine tool steel, alloy steel, mold steel and other high hardened materials.
- Long neck design for deep machining near walls.

DB612 ...series

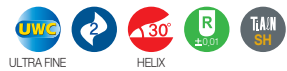

EDP. No.	D ₁	R	L ₁	L ₂	L ₃	D ₂	D ₃	STOCK
DB6120502	0.5	0.25	0.5	2	45	0.45	4	•
DB6120503				3				•
DB6120504				4				•
DB6120505				5				•
DB6120506				6				•
DB6120508				8				•
DB6120510				10				•
DB6120602	0.6	0.3	0.6	2	45	0.55	4	•
DB6120603				3				•
DB6120604				4				•
DB6120605				5				•
DB6120606				6				•
DB6120608				8				•
DB6120610				10				•
DB6120612	12	•						
DB6120702	0.7	0.35	0.7	2	45	0.65	4	•
DB6120704				4				•
DB6120708				8				•
DB6120802	0.8	0.4	0.8	2	45	0.75	4	•
DB6120804				4				•
DB6120805				5				•
DB6120806				6				•
DB6120807				7				•
DB6120808				8				•
DB6120810				10				•
DB6120812				12				•
DB6120816				16	50			•
DB6121003	1	0.5	1	3	45	0.95	4	•
DB6121004				4				•
DB6121005				5				•
DB6121006				6				•
DB6121007				7				•
DB6121008				8				•
DB6121009				9				•
DB6121010				10				•
DB6121012				12				•

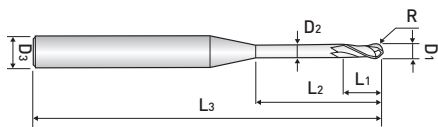

2 FLUTE, for RIB PROCESSING

- Designed for machine tool steel, alloy steel, mold steel and other high hardened materials.
- Long neck design for deep machining near walls.

DB612 ...series



EDP. No.	D ₁	R	L ₁	L ₂	L ₃	D ₂	D ₃	STOCK	
DB6121014	1	0.5	1	14	50	0.95	4	•	
DB6121016				16				•	
DB6121018				18				•	
DB6121020				20	55			•	
DB6121022				22	60			•	
DB6121025				25				•	
DB6121204	1.2	0.6	1.2	4	45	1.15	4	•	
DB6121206				6				•	
DB6121208				8				•	
DB6121210				10				•	
DB6121212				12	50			•	
DB6121216				16				•	
DB6121220				20				55	•
DB6121224				24				60	•
DB6121406	1.4	0.7	1.4	6	45	1.35	4	•	
DB6121408				8				•	
DB6121412				12	•				
DB6121416				16	50			•	
DB6121503	1.5	0.75	1.5	3	45	1.45	4	•	
DB6121504				4				•	
DB6121506				6				•	
DB6121508				8				•	
DB6121510				10				•	
DB6121512				12				50	•
DB6121514				14	•				
DB6121516				16	50				•
DB6121518				18	•				
DB6121520				20	55			•	
DB6121522				22	60			•	
DB6121525				25				•	
DB6121530				30				70	•
DB6121535				35	•				
DB6121606	1.6	0.8	1.6	6	45	1.55	4	•	
DB6121608				8				•	
DB6121610				10				•	
DB6121612				12				•	

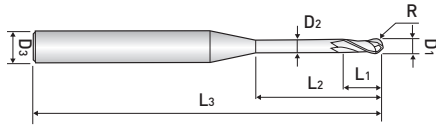

2 FLUTE, for RIB PROCESSING

- Designed for machine tool steel, alloy steel, mold steel and other high hardened materials.
- Long neck design for deep machining near walls.

DB612 ...series

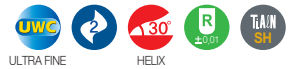

EDP. No.	D ₁	R	L ₁	L ₂	L ₃	D ₂	D ₃	STOCK
DB6121616	1.6	0.8	1.6	16	50	1.55	4	•
DB6121620				20	55			•
DB6121806	1.8	0.9	1.8	6	45	1.75	4	•
DB6121808				8				•
DB6121812				12				•
DB6121816				16	50			•
DB6121820				20	55			•
DB6122004	2	1	2	4	45	1.95	4	•
DB6122006				6				•
DB6122008				8				•
DB6122010				10				•
DB6122012				12				•
DB6122014				14	50			•
DB6122016				16	•			
DB6122018				18	55			•
DB6122020				20	•			
DB6122022				22	60			•
DB6122025				25	65			•
DB6122030				30	70			•
DB6122035				35	•			
DB6122040	40	80	•					
DB6122045	45	•						
DB6122508	2.5	1.25	2.5	8	50	2.4	4	•
DB6122510				10				•
DB6122516				16				•
DB6122520				20	60			•
DB6122525				25	•			
DB6122530				30	70			•
DB6122535	35	•						
DB6123006	3	1.5	3	6	50	2.85	6	•
DB6123008				8				•
DB6123010				10				•
DB6123012				12				•
DB6123014				14	55			•
DB6123016				16	•			
DB6123018				18	60			•

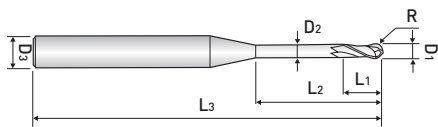

2 FLUTE, for RIB PROCESSING

- Designed for machine tool steel, alloy steel, mold steel and other high hardened materials.
- Long neck design for deep machining near walls.

DB612 ...series



EDP. No.	D ₁	R	L ₁	L ₂	L ₃	D ₂	D ₃	STOCK
DB6123020	3	1.5	3	20	60	2.85	6	•
DB6123025				25	65			•
DB6123030				30	70			•
DB6123035				35	80			•
DB6123040				40				•
DB6123045				45	90			•
DB6123050				50	100			•
DB6123060				60				•
DB6124008				4	2			4
DB6124010	10	•						
DB6124012	12	•						
DB6124016	16	65	•					
DB6124020	20		•					
DB6124025	25	70	•					
DB6124030	30	80	•					
DB6124035	35		•					
DB6124040	40	90	•					
DB6124045	45	100	•					
DB6124050	50		•					
DB6124060	60	•						
DB6125015	5	2.5	5			15	60	
DB6125020				20	•			
DB6125025				25	70	•		
DB6125030				30	80	•		
DB6125035				35		•		
DB6125040				40	90	•		
DB6125045				45	100	•		
DB6125050				50		•		
DB6125060				60	•			

■ Tolerance

Mill Dia. (mm)	Shank Dia.
0 ~ -0.02	h6

※Items can be changed for quality improvement without notice.

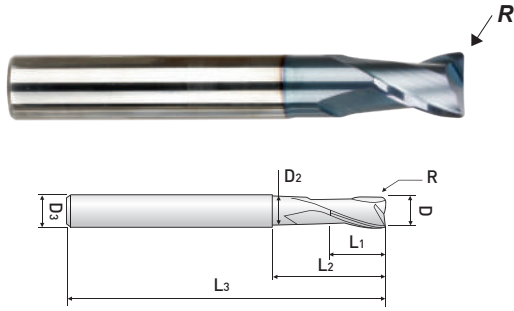

**2 FLUTE, STUB CUT LENGTH,
CORNER RADIUS with EXTENDED NECK**

- Designed to machine tool steel, alloy steel, mold steel and other high hardened materials.
- Superior workpiece finishes.
- Increased feed rate.

ZR502 ...series



EDP. No.	D	R	L ₁	L ₂	L ₃	D ₂	D ₃	STOCK
ZR5020405	4	0.5	6	10	55	3.7	6	•
ZR5020410		1						•
ZR5020605	6	0.5	8	15	55	5.7	6	•
ZR5020610		1						•
ZR5020805	8	0.5	10	20	65	7.7	8	•
ZR5020810		1						•
ZR5020815		1.5						•
ZR5020820		2						•
ZR5021005	10	0.5	12	28	80	9.5	10	•
ZR5021010		1						•
ZR5021015		1.5						•
ZR5021020		2						•
ZR5021205	12	0.5	15	30	82	11.5	12	•
ZR5021210		1						•
ZR5021215		1.5						•
ZR5021220		2						•

■ Tolerance

Mill Dia, (mm)	Shank Dia,
0 ~ -0,02	h6

※Items can be changed for quality improvement without notice.

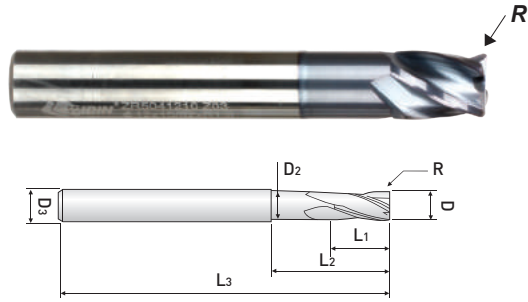

**4 FLUTE, STUB CUT LENGTH,
CORNER RADIUS with EXTENDED NECK**

- Designed to machine tool steel, alloy steel, mold steel and other high hardened materials.
- Superior workpiece finishes.
- Increased feed rate.

ZR504 ...series



EDP. No.	D	R	L ₁	L ₂	L ₃	D ₂	D ₃	STOCK
ZR5040405	4	0.5	6	10	55	3.7	6	•
ZR5040410		1						•
ZR5040605	6	0.5	8	15	55	5.7	6	•
ZR5040610		1						•
ZR5040805	8	0.5	10	20	65	7.7	8	•
ZR5040810		1						•
ZR5040815		1.5						•
ZR5040820		2						•
ZR5041005	10	0.5	12	28	80	9.5	10	•
ZR5041010		1						•
ZR5041015		1.5						•
ZR5041020		2						•
ZR5041205	12	0.5	15	30	82	11.5	12	•
ZR5041210		1						•
ZR5041215		1.5						•
ZR5041220		2						•

■ Tolerance

Mill Dia. (mm)	Shank Dia.
0 ~ -0.02	h6

※ Items can be changed for quality improvement without notice.

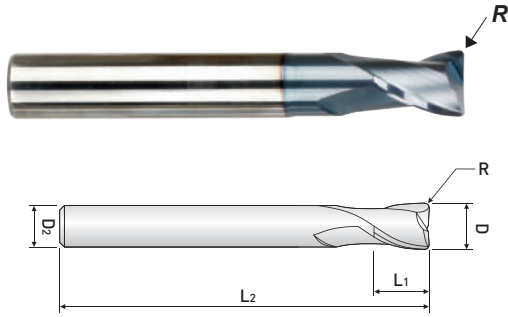

**2 FLUTE, REGULAR LENGTH,
CORNER RADIUS**

- Designed to machine tool steel, alloy steel, mold steel and other high hardened materials.
- Superior workpiece finishes.
- Increased feed rate.

ZR512 ...series

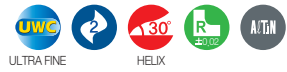

EDP. No.	Dia.	R	L ₁	L ₂	D ₂	STOCK
ZR5120605	6	0.5	15	55	6	•
ZR5120610		1				•
ZR5120805	8	0.5	20	65	8	•
ZR5120810		1				•
ZR5120815		1.5				•
ZR5120820		2				•
ZR5121005	10	0.5	25	80	10	•
ZR5121010		1				•
ZR5121015		1.5				•
ZR5121020		2				•
ZR5121025		2.5				•
ZR5121030	3	•				
ZR5121205	12	0.5	30	82	12	•
ZR5121210		1				•
ZR5121215		1.5				•
ZR5121220		2				•
ZR5121225		2.5				•
ZR5121230	3	•				
ZR5121605	16	0.5	40	100	16	•
ZR5121610		1				•
ZR5121615		1.5				•
ZR5121620		2				•
ZR5121630	3	•				
ZR5122005	20	0.5	45	110	20	•
ZR5122010		1				•
ZR5122015		1.5				•
ZR5122020		2				•
ZR5122030		3				•

■ Tolerance

Mill Dia. (mm)	Shank Dia.
0 ~ -0,03	h6

※ Items can be changed for quality improvement without notice.

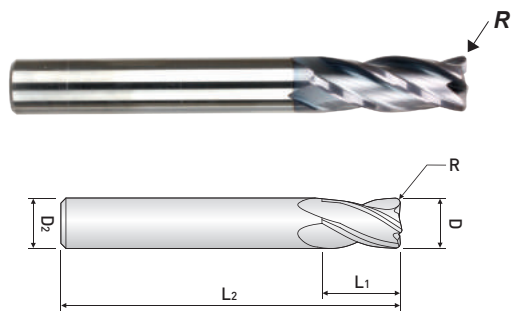

4 FLUTE, REGULAR LENGTH, CORNER RADIUS

- Designed to machine tool steel, alloy steel, mold steel and other high hardened materials.
- Superior workpiece finishes.
- Increased feed rate.

ZR514 ...series



EDP. No.	Dia.	R	L ₁	L ₂	D ₂	STOCK
ZR5140605	6	0.5	15	55	6	•
ZR5140610		1				•
ZR5140805	8	0.5	20	65	8	•
ZR5140810		1				•
ZR5140815		1.5				•
ZR5140820		2				•
ZR5141005	10	0.5	25	80	10	•
ZR5141010		1				•
ZR5141015		1.5				•
ZR5141020		2				•
ZR5141025		2.5				•
ZR5141030	3	•				
ZR5141205	12	0.5	30	82	12	•
ZR5141210		1				•
ZR5141215		1.5				•
ZR5141220		2				•
ZR5141225		2.5				•
ZR5141230	3	•				
ZR5141605	16	0.5	40	100	16	•
ZR5141610		1				•
ZR5141615		1.5				•
ZR5141620		2				•
ZR5141630	3	•				
ZR5142005	20	0.5	45	110	20	•
ZR5142010		1				•
ZR5142015		1.5				•
ZR5142020		2				•
ZR5142030		3				•

■ Tolerance

Mill Dia. (mm)	Shank Dia.
0 ~ -0.03	h6

※Items can be changed for quality improvement without notice.

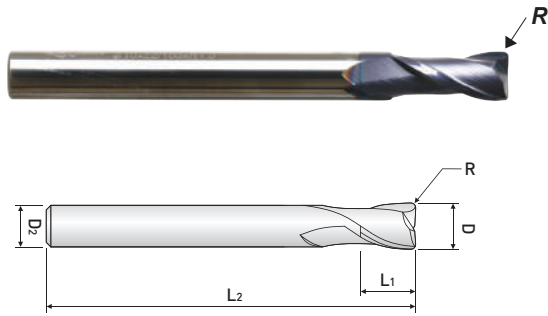

2 FLUTE, LONG LENGTH, CORNER RADIUS

- Designed to machine tool steel, alloy steel, mold steel and other high hardened materials.
- Superior workpiece finishes.
- Increased feed rate.

ZR522 ...series



EDP. No.	Dia.	R	L ₁	L ₂	D ₂	STOCK
ZR5220302S4	3	0.2	8	60	4	•
ZR5220302					6	•
ZR5220305S4		0.5			4	•
ZR5220305					6	•
ZR5220402S4	4	0.2	11	70	4	•
ZR5220402	4	0.2	11	70	6	•
ZR5220405S4		0.5			4	•
ZR5220405		0.5			6	•
ZR5220410		1			6	•
ZR5220502	5	0.2	13	80	6	•
ZR5220505		0.5				•
ZR5220510		1				•
ZR5220602	6	0.2	13	90	6	•
ZR5220605		0.5				•
ZR5220610		1				•
ZR5220805	8	0.5	19	100	8	•
ZR5220810		1				•
ZR5220815		1.5				•
ZR5220820		2				•
ZR5221005	10	0.5	22	100	10	•
ZR5221010		1				•
ZR5221015		1.5				•
ZR5221020		2				•
ZR5221025		2.5				•
ZR5221205	12	0.5	26	110	12	•
ZR5221210		1				•
ZR5221215		1.5				•
ZR5221220		2				•
ZR5221225		2.5				•
ZR5221230		3				•

■ Tolerance

Mill Dia, (mm)	Shank Dia,
0 ~ -0,02	h6

※ Items can be changed for quality improvement without notice.

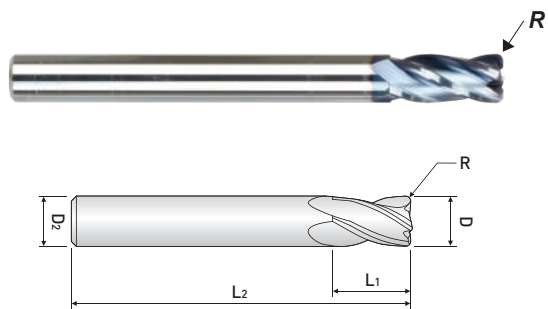

4 FLUTE, LONG LENGTH, CORNER RADIUS

- Designed to machine tool steel, alloy steel, mold steel and other high hardened materials.
- Superior workpiece finishes.
- Increased feed rate.

ZR524 ...series



EDP. No.	Dia.	R	L ₁	L ₂	D ₂	STOCK		
ZR5240302S4	3	0.2	8	60	4	•		
ZR5240302					6	•		
ZR5240305S4	3	0.5	8	60	4	•		
ZR5240305					6	•		
ZR5240402S4	4	0.2	11	70	4	•		
ZR5240402					6	•		
ZR5240405S4		0.5			4	•		
ZR5240405					6	•		
ZR5240410S4	4	1	11	70	4	•		
ZR5240410					6	•		
ZR5240502	5	0.2			13	80	6	•
ZR5240505		0.5						•
ZR5240510		1	•					
ZR5240602	6	0.2	13	90	6	•		
ZR5240605		0.5				•		
ZR5240610		1				•		
ZR5240805	8	0.5	19	100	8	•		
ZR5240810		1				•		
ZR5240815		1.5				•		
ZR5240820		2				•		
ZR5241005	10	0.5	22	100	10	•		
ZR5241010		1				•		
ZR5241015		1.5				•		
ZR5241020		2				•		
ZR5241025		2.5				•		
ZR5241205	12	0.5	26	110	12	•		
ZR5241210		1				•		
ZR5241215		1.5				•		
ZR5241220		2				•		
ZR5241225		2.5				•		
ZR5241230		3				•		

■ Tolerance

Mill Dia. (mm)	Shank Dia.
0 ~ -0.02	h6

※Items can be changed for quality improvement without notice.

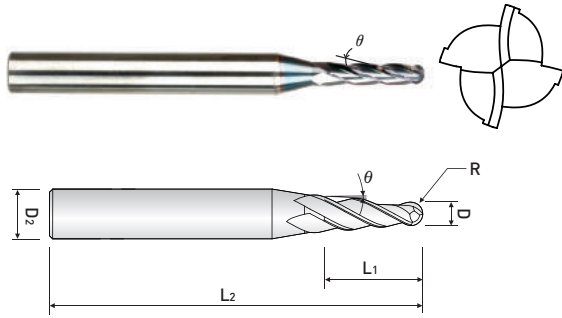

MULTIPLE FLUTES – TAPER BALL ENDMILLS for RIB PROCESSING

- Applying high hardened taper angle on the tool leads to highly efficient Rib processing
- Suitable to do machining performance on the inclined workpiece for electricity and electronic precise mold
- Taper Tolerance : $\pm 10'$

TPRB4...-050 series



EDP. No.	R	θ	L ₁	L ₂	D ₂	STOCK
TPRB4006-04-050	0.3	30'	4	40	4	
TPRB4006-06-050			6			
TPRB4008-06-050	0.4	30'	6	45	4	
TPRB4008-08-050			8			
TPRB4008-10-050			10			
TPRB4010-06-050	0.5	30'	6	45	4	
TPRB4010-08-050			8			
TPRB4010-10-050			10			
TPRB4010-12-050			12			
TPRB4010-16-050			16			
TPRB4012-06-050	0.6	30'	6	45	4	
TPRB4012-08-050			8			
TPRB4012-10-050			10			
TPRB4012-12-050			12			
TPRB4012-16-050			16	50		
TPRB4015-08-050	0.75	30'	8	45	4	
TPRB4015-10-050			10			
TPRB4015-12-050			12			
TPRB4015-16-050			16			
TPRB4015-20-050			20			
TPRB4016-08-050	0.8	30'	8	45	4	
TPRB4016-10-050			10			
TPRB4016-12-050			12			
TPRB4016-16-050			16			
TPRB4016-20-050			20			
TPRB4018-08-050	0.9	30'	8	45	4	
TPRB4018-10-050			10			
TPRB4018-12-050			12			
TPRB4018-16-050			16			
TPRB4018-20-050			20			
TPRB4020-10-050	1.0	30'	10	45	4	
TPRB4020-12-050			12			
TPRB4020-16-050			16			
TPRB4020-20-050			20			
TPRB4020-25-050			25			
TPRB4025-10-050	1.25	30'	10	45	4	
TPRB4025-12-050			12			
TPRB4025-16-050			16			
TPRB4025-20-050			20			
TPRB4025-25-050			25			

※ These tools are manufactured based on order received.

■ Tolerance

Radius (mm)	Shank Dia.
$\pm 0,01$	h6

※ Items can be changed for quality improvement without notice.

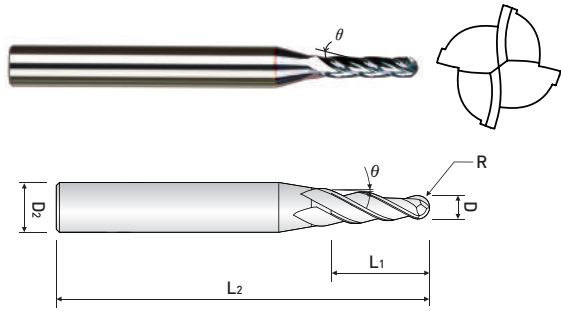

MULTIPLE FLUTES – TAPER BALL ENDMILLS for RIB PROCESSING

- Applying high hardened taper angle on the tool leads to highly efficient Rib processing
- Suitable to do machining performance on the inclined workpiece for electricity and electronic precise mold
- Taper Tolerance : $\pm 10'$

TPRB4...-075 series



EDP. No.	R	θ	L ₁	L ₂	D ₂	STOCK
TPRB4006-04-075	0.3	45°	4	40	4	
TPRB4006-06-075			6			
TPRB4008-06-075	0.4	45°	6	45	4	
TPRB4008-08-075			8			
TPRB4008-10-075			10			
TPRB4010-08-075	0.5	45°	8	45	4	
TPRB4010-10-075			10			
TPRB4010-12-075			12			
TPRB4012-08-075	0.6	45°	8	45	4	
TPRB4012-10-075			10			
TPRB4012-12-075			12			
TPRB4012-16-075			16			
TPRB4015-08-075	0.75	45°	8	45	4	
TPRB4015-10-075			10			
TPRB4015-12-075			12			
TPRB4015-16-075			16			
TPRB4015-20-075			20			
TPRB4016-08-075	0.8	45°	8	45	4	
TPRB4016-10-075			10			
TPRB4016-12-075			12			
TPRB4016-16-075			16			
TPRB4016-20-075			20			
TPRB4018-08-075	0.9	45°	8	45	4	
TPRB4018-10-075			10			
TPRB4018-12-075			12			
TPRB4018-16-075			16			
TPRB4018-20-075			20			
TPRB4020-10-075	1.0	45°	10	45	4	
TPRB4020-12-075			12			
TPRB4020-16-075			16			
TPRB4020-20-075			20			
TPRB4020-25-075			25			
TPRB4025-10-075	1.25	45°	10	45	4	
TPRB4025-12-075			12			
TPRB4025-16-075			16			
TPRB4025-20-075			20			
TPRB4025-25-075			25			

※ These tools are manufactured based on order received.

■ Tolerance

Radius (mm)	Shank Dia.
± 0.01	h6

※ Items can be changed for quality improvement without notice.

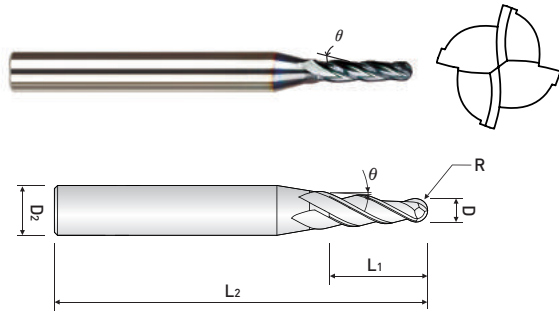

MULTIPLE FLUTES – TAPER BALL ENDMILLS for RIB PROCESSING

- Applying high hardened taper angle on the tool leads to highly efficient Rib processing
- Suitable to do machining performance on the inclined workpiece for electricity and electronic precise mold
- Taper Tolerance : $\pm 10'$

TPRB4...-100 series



EDP. No.	R	θ	L ₁	L ₂	D ₂	STOCK
TPRB4006-04-100	0.3	1°00'	4	40	4	
TPRB4006-06-100			6			
TPRB4008-06-100	0.4	1°00'	6	45	4	
TPRB4008-08-100			8			
TPRB4008-10-100			10			
TPRB4010-06-100	0.5	1°00'	6	45	4	
TPRB4010-08-100			8			
TPRB4010-10-100			10			
TPRB4010-12-100			12			
TPRB4010-16-100			16			
TPRB4012-06-100	0.6	1°00'	6	45	4	
TPRB4012-08-100			8			
TPRB4012-10-100			10			
TPRB4012-12-100			12			
TPRB4012-16-100			16			
TPRB4015-08-100	0.75	1°00'	8	45	4	
TPRB4015-10-100			10			
TPRB4015-12-100			12			
TPRB4015-16-100			16			
TPRB4015-20-100			20			
TPRB4016-08-100	0.8	1°00'	8	45	4	
TPRB4016-10-100			10			
TPRB4016-12-100			12			
TPRB4016-16-100			16			
TPRB4016-20-100			20			
TPRB4018-08-100	0.9	1°00'	8	45	4	
TPRB4018-10-100			10			
TPRB4018-12-100			12			
TPRB4018-16-100			16			
TPRB4018-20-100			20			

※ These tools are manufactured based on order received.

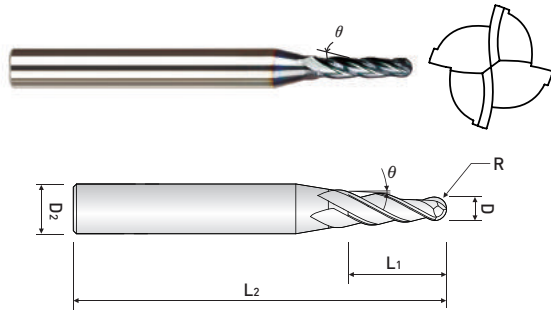

MULTIPLE FLUTES – TAPER BALL ENDMILLS for RIB PROCESSING

- Applying high hardened taper angle on the tool leads to highly efficient Rib processing
- Suitable to do machining performance on the inclined workpiece for electricity and electronic precise mold
- Taper Tolerance : $\pm 10'$

TPRB4...-100 series



EDP. No.	R	θ	L ₁	L ₂	D ₂	STOCK
TPRB4020-10-100	1.0	1°00'	10	45	4	
TPRB4020-12-100			12			
TPRB4020-16-100			16	50		
TPRB4020-20-100			20	55		
TPRB4020-25-100			25			
TPRB4025-10-100	1.25	1°00'	10	45	4	
TPRB4025-12-100			12			
TPRB4025-16-100			16	50		
TPRB4025-20-100			20	55		
TPRB4025-25-100			25			

※ These tools are manufactured based on order received.

■ Tolerance

Radius (mm)	Shank Dia.
$\pm 0,01$	h6

※ Items can be changed for quality improvement without notice.

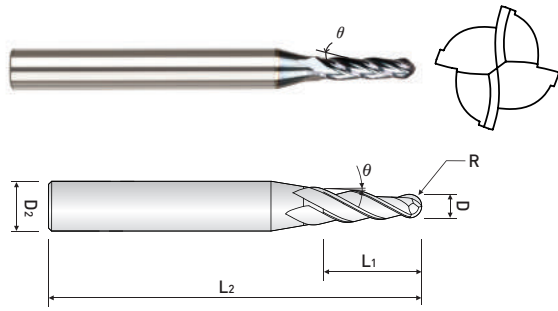

MULTIPLE FLUTES – TAPER BALL ENDMILLS for RIB PROCESSING

- Applying high hardened taper angle on the tool leads to highly efficient Rib processing
- Suitable to do machining performance on the inclined workpiece for electricity and electronic precise mold
- Taper Tolerance : $\pm 10'$

TPRB4...-150 series



EDP. No.	R	θ	L ₁	L ₂	D ₂	STOCK
TPRB4006-04-150	0.3	1°30'	4	40	4	
TPRB4006-06-150			6			
TPRB4008-06-150	0.4	1°30'	6	45	4	
TPRB4008-08-150			8			
TPRB4008-10-150			10			
TPRB4010-06-150	0.5	1°30'	6	45	4	
TPRB4010-08-150			8			
TPRB4010-10-150			10			
TPRB4010-12-150			12			
TPRB4010-16-150			16			
TPRB4012-06-150	0.6	1°30'	6	45	4	
TPRB4012-08-150			8			
TPRB4012-10-150			10			
TPRB4012-12-150			12			
TPRB4012-16-150			16			
TPRB4015-08-150	0.75	1°30'	8	45	4	
TPRB4015-10-150			10			
TPRB4015-12-150			12			
TPRB4015-16-150			16			
TPRB4015-20-150			20			
TPRB4016-08-150	0.8	1°30'	8	45	4	
TPRB4016-10-150			10			
TPRB4016-12-150			12			
TPRB4016-16-150			16			
TPRB4016-20-150			20			
TPRB4018-08-150	0.9	1°30'	8	45	4	
TPRB4018-10-150			10			
TPRB4018-12-150			12			
TPRB4018-16-150			16			
TPRB4018-20-150			20			

※ These tools are manufactured based on order received.

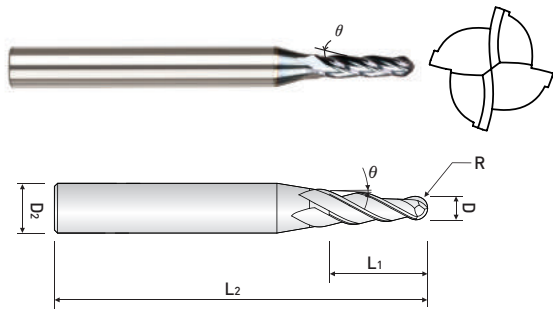

MULTIPLE FLUTES – TAPER BALL ENDMILLS for RIB PROCESSING

- Applying high hardened taper angle on the tool leads to highly efficient Rib processing
- Suitable to do machining performance on the inclined workpiece for electricity and electronic precise mold
- Taper Tolerance : $\pm 10'$

TPRB4...-150 series



EDP. No.	R	θ	L ₁	L ₂	D ₂	STOCK
TPRB4020-10-150	1.0	1°30'	10	45	4	
TPRB4020-12-150			12			
TPRB4020-16-150			16	50		
TPRB4020-20-150			20	55		
TPRB4020-25-150			25	60		
TPRB4020-30-150			30	60		
TPRB4025-10-150	1.25	1°30'	10	45	4	
TPRB4025-12-150			12			
TPRB4025-16-150			16	50		
TPRB4025-20-150			20	55		
TPRB4025-25-150			25	60		
TPRB4025-30-150			30	60		

※ These tools are manufactured based on order received.

■ Tolerance

Radius (mm)	Shank Dia.
$\pm 0,01$	h6

※ Items can be changed for quality improvement without notice.

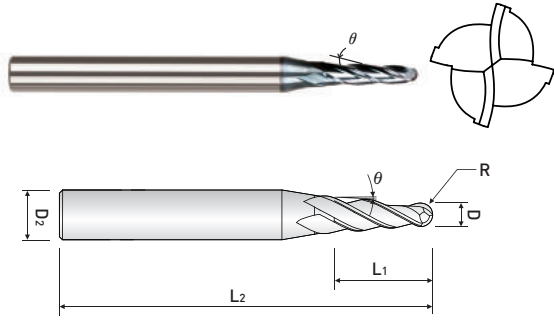

MULTIPLE FLUTES – TAPER BALL ENDMILLS for RIB PROCESSING

- Applying high hardened taper angle on the tool leads to highly efficient Rib processing
- Suitable to do machining performance on the inclined workpiece for electricity and electronic precise mold
- Taper Tolerance : $\pm 10'$

TPRB4...-200 series



EDP. No.	R	θ	L ₁	L ₂	D ₂	STOCK
TPRB4006-04-200	0.3	2°00'	4	40	4	
TPRB4006-06-200			6			
TPRB4008-06-200	0.4	2°00'	6	45	4	
TPRB4008-08-200			8			
TPRB4008-10-200			10			
TPRB4010-06-200	0.5	2°00'	6	45	4	
TPRB4010-08-200			8			
TPRB4010-10-200			10			
TPRB4010-12-200			12			
TPRB4010-16-200			16			
TPRB4012-06-200	0.6	2°00'	6	45	4	
TPRB4012-08-200			8			
TPRB4012-10-200			10			
TPRB4012-12-200			12			
TPRB4012-16-200			16			
TPRB4015-08-200	0.75	2°00'	8	45	4	
TPRB4015-10-200			10			
TPRB4015-12-200			12			
TPRB4015-16-200			16			
TPRB4015-20-200			20			
TPRB4016-08-200	0.8	2°00'	8	45	4	
TPRB4016-10-200			10			
TPRB4016-12-200			12			
TPRB4016-16-200			16			
TPRB4016-20-200			20			
TPRB4018-08-200	0.9	2°00'	8	45	4	
TPRB4018-10-200			10			
TPRB4018-12-200			12			
TPRB4018-16-200			16			
TPRB4018-20-200			20			

※ These tools are manufactured based on order received.

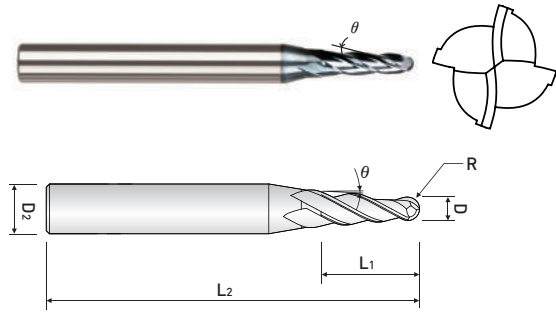

MULTIPLE FLUTES – TAPER BALL ENDMILLS for RIB PROCESSING

- Applying high hardened taper angle on the tool leads to highly efficient Rib processing
- Suitable to do machining performance on the inclined workpiece for electricity and electronic precise mold
- Taper Tolerance : $\pm 10'$

TPRB4...-200 series



EDP. No.	R	θ	L ₁	L ₂	D ₂	STOCK
TPRB4020-10-200	1.0	2°00'	10	45	4	
TPRB4020-12-200			12			
TPRB4020-16-200			16	50		
TPRB4020-20-200			20	55		
TPRB4020-25-200			25	60		
TPRB4020-30-200			30	60		
TPRB4025-10-200	1.25	2°00'	10	45	4	
TPRB4025-12-200			12			
TPRB4025-16-200			16	50		
TPRB4025-20-200			20	55		
TPRB4025-25-200			25	60		
TPRB4025-30-200			30	60		

※ These tools are manufactured based on order received.

■ Tolerance

Radius (mm)	Shank Dia.
$\pm 0,01$	h6

※ Items can be changed for quality improvement without notice.

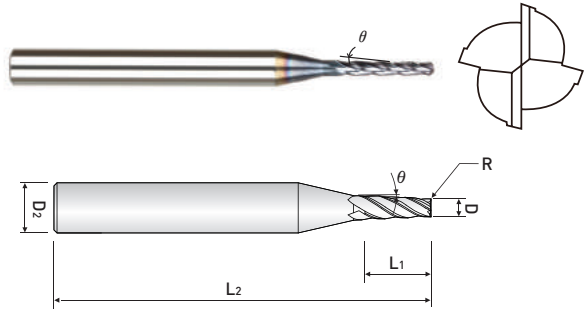

**MULTIPLE FLUTES - TAPER ENDMILLS
for RIB PROCESSING**

- Rigid taper end mill for highly productive rib processing.
- Can also be used for side milling operation.
- Taper Tolerance : $\pm 10'$

TPRE4...-050 series



EDP. No.	Dia.	θ	L ₁	L ₂	D ₂	STOCK
TPRE4004-02-050	0.4	30°	2	40	4	
TPRE4004-03-050			3			
TPRE4004-04-050			4			
TPRE4005-02-050	0.5	30°	2	40	4	
TPRE4005-04-050			4			
TPRE4005-06-050			6			
TPRE4006-04-050	0.6	30°	4	40	4	
TPRE4006-06-050			6			
TPRE4007-06-050	0.7	30°	6	40	4	
TPRE4007-08-050			8			
TPRE4008-06-050	0.8	30°	6	45	4	
TPRE4008-08-050			8			
TPRE4008-10-050			10			
TPRE4009-06-050	0.9	30°	6	45	4	
TPRE4009-08-050			8			
TPRE4009-10-050			10			
TPRE4010-06-050	1.0	30°	6	45	4	
TPRE4010-08-050			8			
TPRE4010-10-050			10			
TPRE4010-12-050			12			
TPRE4010-16-050			16	50		
TPRE4012-06-050	1.2	30°	6	45	4	
TPRE4012-08-050			8			
TPRE4012-10-050			10			
TPRE4012-12-050			12			
TPRE4012-16-050			16	50		
TPRE4014-08-050	1.4	30°	8	45	4	
TPRE4014-12-050			12			
TPRE4014-16-050			16	50		

※ These tools are manufactured based on order received.

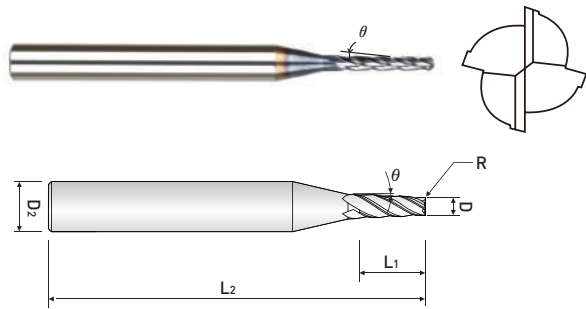

MULTIPLE FLUTES - TAPER ENDMILLS for RIB PROCESSING

- Rigid taper end mill for highly productive rib processing.
- Can also be used for side milling operation.
- Taper Tolerance : $\pm 10'$

TPRE4...-050 series



EDP. No.	Dia.	θ	L ₁	L ₂	D ₂	STOCK
TPRE4015-08-050	1.5	30°	8	45	4	
TPRE4015-10-050			10			
TPRE4015-12-050			12			
TPRE4015-16-050			16			
TPRE4015-20-050			20			
TPRE4016-08-050	1.6	30°	8	45	4	
TPRE4016-10-050			10			
TPRE4016-12-050			12			
TPRE4016-16-050			16			
TPRE4016-20-050			20			
TPRE4018-08-050	1.8	30°	8	45	4	
TPRE4018-10-050			10			
TPRE4018-12-050			12			
TPRE4018-16-050			16			
TPRE4018-20-050			20			
TPRE4020-10-050	2.0	30°	10	45	4	
TPRE4020-12-050			12			
TPRE4020-16-050			16			
TPRE4020-20-050			20			
TPRE4020-25-050			25			
TPRB4025-10-050	2.5	30°	10	45	4	
TPRB4025-12-050			12			
TPRB4025-16-050			16			
TPRB4025-20-050			20			
TPRB4025-25-050			25			
TPRB4025-30-050			30			

※ These tools are manufactured based on order received.

■ Tolerance

Mill Dia. (mm)	Shank Dia.
0 ~ -0.03	h6

※ Items can be changed for quality improvement without notice.

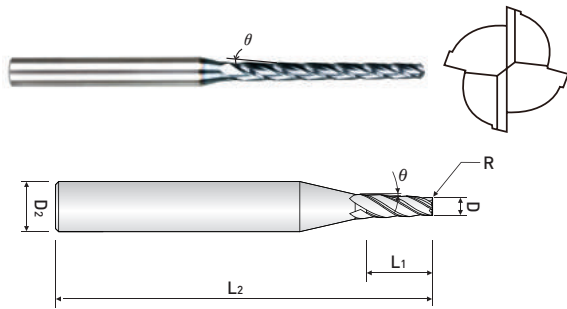

**MULTIPLE FLUTES - TAPER ENDMILLS
for RIB PROCESSING**

- Rigid taper end mill for highly productive rib processing.
- Can also be used for side milling operation.
- Taper Tolerance : $\pm 10'$

TPRE4...-075 series



EDP. No.	Dia.	θ	L ₁	L ₂	D ₂	STOCK
TPRE4004-02-075	0.4	45'	2	40	4	
TPRE4004-03-075			3			
TPRE4004-04-075			4			
TPRE4005-04-075	0.5	45'	4	40	4	
TPRE4005-06-075			6			
TPRE4006-04-075	0.6	45'	4	40	4	
TPRE4006-06-075			6			
TPRE4007-06-075	0.7	45'	6	40	4	
TPRE4007-08-075			8			
TPRE4008-06-075	0.8	45'	6	45	4	
TPRE4008-08-075			8			
TPRE4008-10-075			10			
TPRE4009-06-075	0.9	45'	6	45	4	
TPRE4009-08-075			8			
TPRE4009-10-075			10			
TPRE4010-08-075	1.0	45'	8	45	4	
TPRE4010-10-075			10			
TPRE4010-12-075			12			
TPRE4012-08-075	1.2	45'	8	45	4	
TPRE4012-10-075			10			
TPRE4012-12-075			12			
TPRE4012-16-075			16	50		
TPRE4015-08-075	1.5	45'	8	45	4	
TPRE4015-10-075			10			
TPRE4015-12-075			12			
TPRE4015-16-075			16	50		
TPRE4015-20-075			20	55		

※ These tools are manufactured based on order received.

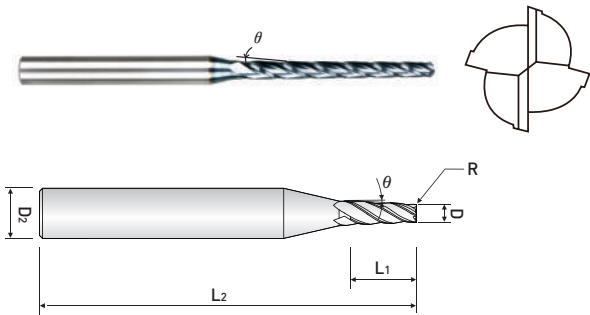

MULTIPLE FLUTES - TAPER ENDMILLS for RIB PROCESSING

- Rigid taper end mill for highly productive rib processing.
- Can also be used for side milling operation.
- Taper Tolerance : $\pm 10'$

TPRE4...-075 series



EDP. No.	Dia.	θ	L ₁	L ₂	D ₂	STOCK
TPRE4016-08-075	1.6	45°	8	45	4	
TPRE4016-10-075			10			
TPRE4016-12-075			12			
TPRE4016-16-075			16			
TPRE4016-20-075			20			
TPRE4018-08-075	1.8	45°	8	45	4	
TPRE4018-10-075			10			
TPRE4018-12-075			12			
TPRE4018-16-075			16			
TPRE4018-20-075			20			
TPRE4020-10-075	2.0	45°	10	45	4	
TPRE4020-12-075			12			
TPRE4020-16-075			16	50		
TPRE4020-20-075			20			
TPRE4020-25-075			25	55		
TPRE4025-10-075	2.5	45°	10	45	4	
TPRE4025-12-075			12			
TPRE4025-16-075			16	50		
TPRE4025-20-075			20			
TPRE4025-25-075			25	55		
TPRE4025-30-075			30			
TPRE4030-25-075	3.0	45°	25	55	4	
TPRE4030-40-075			40	80	6	

※ These tools are manufactured based on order received.

■ Tolerance

Mill Dia. (mm)	Shank Dia.
0 ~ -0.03	h6

※ Items can be changed for quality improvement without notice.

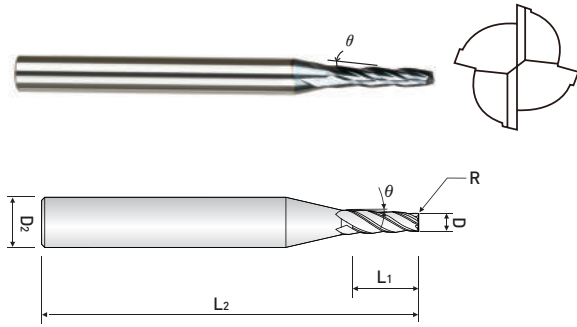

MULTIPLE FLUTES - TAPER ENDMILLS for RIB PROCESSING

- Rigid taper end mill for highly productive rib processing.
- Can also be used for side milling operation.
- Taper Tolerance : $\pm 10'$

TPRE4...-100 series



EDP. No.	Dia.	θ	L ₁	L ₂	D ₂	STOCK
TPRE4004-02-100	0.4	1°00'	2	40	4	
TPRE4004-03-100			3			
TPRE4004-04-100			4			
TPRE4005-02-100	0.5	1°00'	2	40	4	
TPRE4005-04-100			4			
TPRE4005-06-100			6			
TPRE4006-04-100	0.6	1°00'	4	40	4	
TPRE4006-06-100			6			
TPRE4007-06-100	0.7	1°00'	6	40	4	
TPRE4007-08-100			8			
TPRE4008-06-100	0.8	1°00'	6	45	4	
TPRE4008-08-100			8			
TPRE4008-10-100			10			
TPRE4009-06-100	0.9	1°00'	6	45	4	
TPRE4009-08-100			8			
TPRE4009-10-100			10			
TPRE4010-06-100	1.0	1°00'	6	45	4	
TPRE4010-08-100			8			
TPRE4010-10-100			10			
TPRE4010-12-100			12			
TPRE4010-16-100			16	50		
TPRE4012-06-100	1.2	1°00'	6	45	4	
TPRE4012-08-100			8			
TPRE4012-10-100			10			
TPRE4012-12-100			12			
TPRE4012-16-100			16	50		
TPRE4014-08-100	1.4	1°00'	8	45	4	
TPRE4014-12-100			12			
TPRE4014-16-100			16	50		

※ These tools are manufactured based on order received.

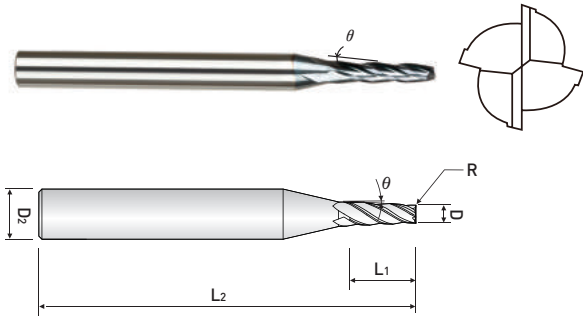

MULTIPLE FLUTES - TAPER ENDMILLS for RIB PROCESSING

- Rigid taper end mill for highly productive rib processing.
- Can also be used for side milling operation.
- Taper Tolerance : $\pm 10'$

TPRE4...-100 series



EDP. No.	Dia.	θ	L ₁	L ₂	D ₂	STOCK
TPRE4015-08-100	1.5	1°00'	8	45	4	
TPRE4015-10-100			10			
TPRE4015-12-100			12			
TPRE4015-16-100			16			
TPRE4015-20-100			20			
TPRE4016-08-100	1.6	1°00'	8	45	4	
TPRE4016-10-100			10			
TPRE4016-12-100			12			
TPRE4016-16-100			16			
TPRE4016-20-100			20			
TPRE4018-08-100	1.8	1°00'	8	45	4	
TPRE4018-10-100			10			
TPRE4018-12-100			12			
TPRE4018-16-100			16			
TPRE4018-20-100			20			
TPRE4020-10-100	2.0	1°00'	10	45	4	
TPRE4020-12-100			12			
TPRE4020-16-100			16			
TPRE4020-20-100			20			
TPRE4020-25-100			25			
TPRE4025-10-100	2.5	1°00'	10	45	4	
TPRE4025-12-100			12			
TPRE4025-16-100			16			
TPRE4025-20-100			20			
TPRE4025-25-100			25			
TPRE4025-30-100			30			
TPRE4030-25-100	3.0	1°00'	25	55	4	
TPRE4030-40-100			40	80	6	

※ These tools are manufactured based on order received.

■ Tolerance

Mill Dia. (mm)	Shank Dia.
0 ~ -0.03	h6

※ Items can be changed for quality improvement without notice.

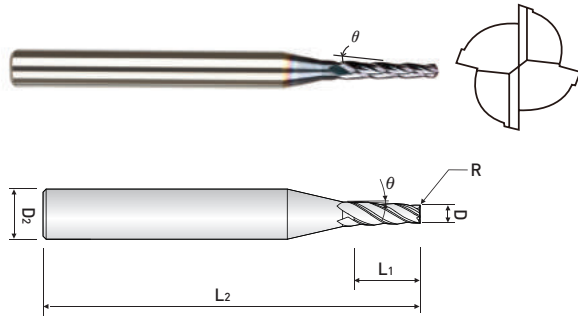

MULTIPLE FLUTES - TAPER ENDMILLS for RIB PROCESSING

- Rigid taper end mill for highly productive rib processing.
- Can also be used for side milling operation.
- Taper Tolerance : $\pm 10'$

TPRE4...-150 series



EDP. No.	Dia.	θ	L ₁	L ₂	D ₂	STOCK
TPRE4004-02-150	0.4	1°30'	2	40	4	
TPRE4004-03-150			3			
TPRE4004-04-150			4			
TPRE4005-04-150	0.5	1°30'	4	40	4	
TPRE4005-06-150			6			
TPRE4006-04-150	0.6	1°30'	4	40	4	
TPRE4006-06-150			6			
TPRE4007-06-150	0.7	1°30'	6	40	4	
TPRE4007-08-150			8			
TPRE4008-06-150	0.8	1°30'	6	45	4	
TPRE4008-08-150			8			
TPRE4008-10-150			10			
TPRE4009-06-150	0.9	1°30'	6	45	4	
TPRE4009-08-150			8			
TPRE4009-10-150			10			
TPRE4010-06-150	1.0	1°30'	6	45	4	
TPRE4010-08-150			8			
TPRE4010-10-150			10			
TPRE4010-12-150			12			
TPRE4010-16-150			16	50		
TPRE4012-06-150	1.2	1°30'	6	45	4	
TPRE4012-08-150			8			
TPRE4012-10-150			10			
TPRE4012-12-150			12			
TPRE4012-16-150			16	50		
TPRE4014-08-150	1.4	1°30'	8	45	4	
TPRE4014-12-150			12			
TPRE4014-16-150			16	50		

※ These tools are manufactured based on order received.

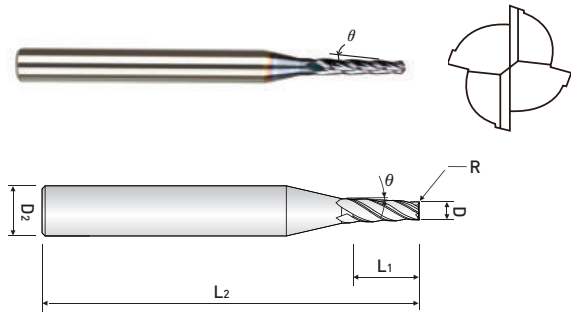

MULTIPLE FLUTES - TAPER ENDMILLS for RIB PROCESSING

- Rigid taper end mill for highly productive rib processing.
- Can also be used for side milling operation.
- Taper Tolerance : $\pm 10'$

TPRE4...-150 series



EDP. No.	Dia.	θ	L ₁	L ₂	D ₂	STOCK
TPRE4015-08-150	1.5	1°30'	8	45	4	
TPRE4015-10-150			10			
TPRE4015-12-150			12			
TPRE4015-16-150			16			
TPRE4015-20-150			20			
TPRE4016-08-150	1.6	1°30'	8	45	4	
TPRE4016-10-150			10			
TPRE4016-12-150			12			
TPRE4016-16-150			16			
TPRE4016-20-150			20			
TPRE4018-08-150	1.8	1°30'	8	45	4	
TPRE4018-10-150			10			
TPRE4018-12-150			12			
TPRE4018-16-150			16			
TPRE4018-20-150			20			
TPRE4020-10-150	2.0	1°30'	10	45	4	
TPRE4020-12-150			12			
TPRE4020-16-150			16			
TPRE4020-20-150			20			
TPRE4020-25-150			25			
TPRE4025-10-150	2.5	1°30'	10	45	4	
TPRE4025-12-150			12			
TPRE4025-16-150			16			
TPRE4025-20-150			20			
TPRE4025-25-150			25			
TPRE4025-30-150			30			
TPRE4030-25-150	3.0	1°30'	25	60	6	
TPRE4030-40-150			40	80		

※ These tools are manufactured based on order received.

■ Tolerance

Mill Dia. (mm)	Shank Dia.
0 ~ -0.03	h6

※ Items can be changed for quality improvement without notice.

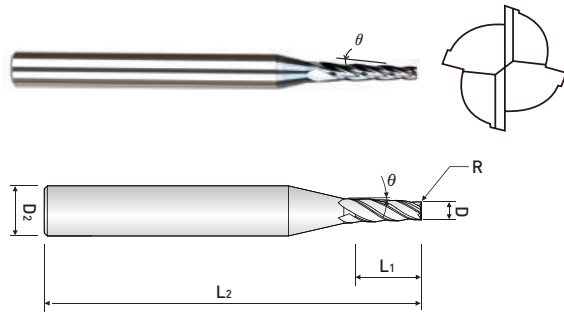

**MULTIPLE FLUTES - TAPER ENDMILLS
for RIB PROCESSING**

- Rigid taper end mill for highly productive rib processing.
- Can also be used for side milling operation.
- Taper Tolerance : $\pm 10'$

TPRE4...-200 series



EDP. No.	Dia.	θ	L ₁	L ₂	D ₂	STOCK
TPRE4004-02-200	0.4	2°00'	2	40	4	
TPRE4004-03-200			3			
TPRE4004-04-200			4			
TPRE4005-04-200	0.5	2°00'	4	40	4	
TPRE4005-06-200			6			
TPRE4006-04-200	0.6	2°00'	4	40	4	
TPRE4006-06-200			6			
TPRE4007-06-200	0.7	2°00'	6	40	4	
TPRE4007-08-200			8			
TPRE4008-06-200	0.8	2°00'	6	45	4	
TPRE4008-08-200			8			
TPRE4008-10-200			10			
TPRE4009-06-200	0.9	2°00'	6	45	4	
TPRE4009-08-200			8			
TPRE4009-10-200			10			
TPRE4010-06-200	1.0	2°00'	6	45	4	
TPRE4010-08-200			8			
TPRE4010-10-200			10			
TPRE4010-12-200			12			
TPRE4010-16-200			16	50		
TPRE4012-06-200	1.2	2°00'	6	45	4	
TPRE4012-08-200			8			
TPRE4012-10-200			10			
TPRE4012-12-200			12			
TPRE4012-16-200			16	50		
TPRE4014-08-200	1.4	2°00'	8	45	4	
TPRE4014-12-200			12			
TPRE4014-16-200			16	50		

※ These tools are manufactured based on order received.

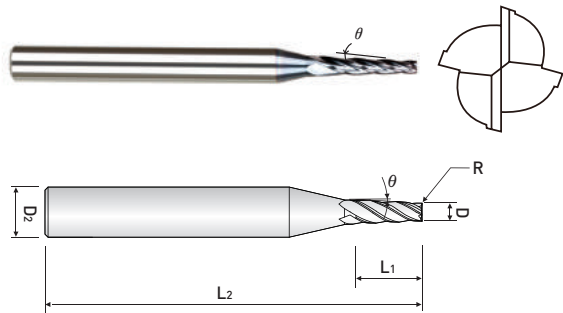

MULTIPLE FLUTES - TAPER ENDMILLS for RIB PROCESSING

- Rigid taper end mill for highly productive rib processing.
- Can also be used for side milling operation.
- Taper Tolerance : $\pm 10'$

TPRE4...-200 series



EDP. No.	Dia.	θ	L ₁	L ₂	D ₂	STOCK
TPRE4015-08-200	1.5	2°00'	8	45	4	
TPRE4015-10-200			10			
TPRE4015-12-200			12			
TPRE4015-16-200			16			
TPRE4015-20-200			20			
TPRE4016-08-200	1.6	2°00'	8	45	4	
TPRE4016-10-200			10			
TPRE4016-12-200			12			
TPRE4016-16-200			16			
TPRE4016-20-200			20			
TPRE4018-08-200	1.8	2°00'	8	45	4	
TPRE4018-10-200			10			
TPRE4018-12-200			12			
TPRE4018-16-200			16			
TPRE4018-20-200			20			
TPRE4020-10-200	2.0	2°00'	10	45	4	
TPRE4020-12-200			12			
TPRE4020-16-200			16			
TPRE4020-20-200			20			
TPRE4020-25-200			25			
TPRE4025-10-200	2.5	2°00'	10	45	4	
TPRE4025-12-200			12			
TPRE4025-16-200			16			
TPRE4025-20-200			20	55	6	
TPRE4025-25-200			25	60		
TPRE4025-30-200			30	65		
TPRE4030-25-200	3.0	2°00'	25	60	6	
TPRE4030-40-200			40	80		

※ These tools are manufactured based on order received.

■ Tolerance

Mill Dia. (mm)	Shank Dia.
0 ~ -0.03	h6

※ Items can be changed for quality improvement without notice.

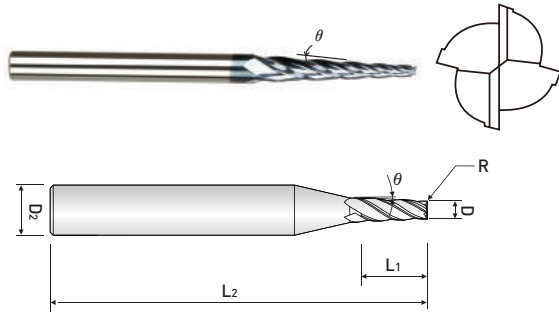

MULTIPLE FLUTES - TAPER ENDMILLS for RIB PROCESSING

- Rigid taper end mill for highly productive rib processing.
- Can also be used for side milling operation.
- Taper Tolerance : $\pm 10'$

TPRE4...-300 series



EDP. No.	Dia.	θ	L ₁	L ₂	D ₂	STOCK
TPRE4005-04-300	0.5	3°00'	4	40	4	
TPRE4006-04-300	0.6	3°00'	4	40	4	
TPRE4007-06-300	0.7	3°00'	6	40	4	
TPRE4008-06-300	0.8	3°00'	6	45	4	
TPRE4008-10-300			10			
TPRE4009-08-300	0.9	3°00'	8	45	4	
TPRE4010-08-300	1.0	3°00'	8	45	4	
TPRE4010-12-300			12			
TPRE4012-10-300	1.2	3°00'	10	45	4	
TPRE4012-16-300			16	50		
TPRE4015-12-300	1.5	3°00'	12	45	4	
TPRE4015-20-300			20	55		
TPRE4016-12-300	1.6	3°00'	12	45	4	
TPRE4016-20-300			20	55		
TPRE4018-12-300	1.8	3°00'	12	45	4	
TPRE4018-20-300			20	55		
TPRE4020-16-300	2.0	3°00'	16	50	4	
TPRE4020-25-300			25	60	6	
TPRE4025-20-300	2.5	3°00'	20	60	6	
TPRE4025-30-300			30	65		
TPRE4030-25-300	3.0	2°00'	25	60	6	
TPRE4030-40-300			40	80	8	

※ These tools are manufactured based on order received.

■ Tolerance

Mill Dia, (mm)	Shank Dia,
0 ~ -0,03	h6

※ Items can be changed for quality improvement without notice.

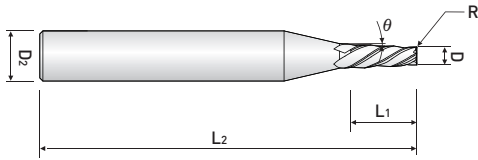

3 FLUTE, TAPER END MILL

- Designed to machine tool steel, alloy steel, mold steel and other high hardened materials.
- ALTiN coated for high wear resistance.

TE503series



EDP. No.	Dia.	θ°	L ₁	N.D	L ₂	D ₂	STOCK
TE50303106	3	1	10	3.4	50	6	
TE50303206		2		3.7			
TE50303306		3		4			
TE50303506		5		4.8			
TE50304106	4	1	15	4.5	50	6	
TE50304206		2		5			
TE50304306		3		5.6			
TE50304508		5		6.6			
TE50305106	5	1	20	5.7	60	6	
TE50305208		2		6.4			
TE50305308		3		7.1			
TE50305508		5		(17.1)		8.5	
TE50306108	6	1	20	6.7	60	8	
TE50306208		2		7.4			
TE50306308		3		8.1			
TE50306510		5		9.5			
TE50308110	8	1	25	8.9	70	10	
TE50308210		2		9.8			
TE50308312		3		10.6			
TE50308512		5		(22.8)			
TE50310112	10	1	35	11.2	90	12	
TE50310212		2	28	12.4			
TE50310314		3	35	13.7			
TE50310516		5	35	16.1			

※ These tools are manufactured based on order received.

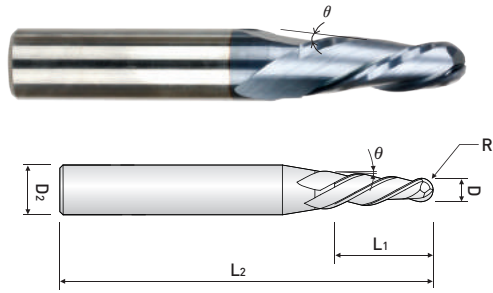

3 FLUTE, TAPER BALL END MILL

- Designed to machine tool steel, alloy steel, mold steel and other high hardened materials.
- ALTiN coated for high wear resistance.

TB503 ...series



EDP. No.	Dia.	R	θ	L ₁	L ₂	D ₂	STOCK
TB50315306	3	1.5	3°	12	60	6	
TB50320306	4	2		15	60	6	
TB50325308	5	2.5		18	60	8	
TB50330310	6	3		22	70	10	
TB50340312	8	4		26	75	12	
TB50350312	10	5		19	75	12	
TB50360316	12	6		36	90	16	
TB50315506	3	1.5	5°	12	60	6	
TB50320508	4	2		15	60	8	
TB50325510	5	2.5		18	70	10	
TB50330510	6	3		22	70	10	
TB50340512	8	4		26	75	12	
TB50350516	10	5		30	90	16	
TB50360520	12	6		36	100	20	
TB50315706	3	1.5	7°	12	60	6	
TB50320708	4	2		15	60	8	
TB50325710	5	2.5		18	70	10	
TB50330712	6	3		22	75	12	
TB50340716	8	4		26	90	16	
TB50350716	10	5		30	90	16	
TB50360720	12	6		36	100	20	

※ These tools are manufactured based on order received.

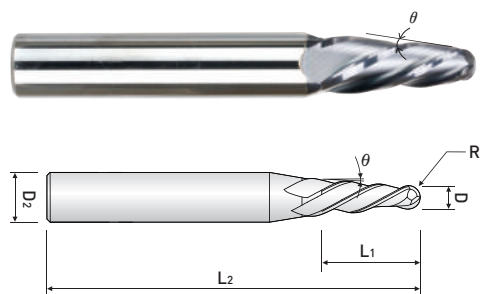

4 FLUTE, TAPER BALL END MILL

- Designed to machine tool steel, alloy steel, mold steel and other high hardened materials.
- ALTiN coated for high wear resistance.

TB504 ...series



EDP. No.	Dia.	R	θ	L ₁	L ₂	D ₂	STOCK
TB50425308	5	2.5	3°	18	60	8	
TB50430310	6	3		22	70	10	
TB50440312	8	4		26	75	12	
TB50450312	10	5		19	75	12	
TB50460316	12	6		36	90	16	
TB50425510	5	2.5	5°	18	70	10	
TB50430510	6	3		22	70	10	
TB50440512	8	4		26	75	12	
TB50450516	10	5		30	90	16	
TB50460520	12	6		36	100	20	
TB50425710	5	2.5	7°	18	70	10	
TB50430712	6	3		22	75	12	
TB50440716	8	4		26	90	16	
TB50450716	10	5		30	90	16	
TB50460720	12	6		36	100	20	

※ These tools are manufactured based on order received.

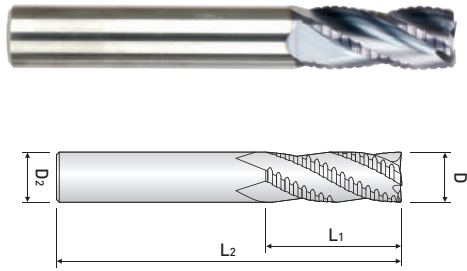

3~6 FLUTE, ROUGHING & FINISHING END MILL

- Designed to machine tool steel, alloy steel, mold steel and other high hardened materials.
- ALTiN coated for high wear resistance.
- Rough & finish type.

ZF60series



EDP. No.	Dia.	L ₁	L ₂	D ₂	STOCK
ZF603040	4	10	50	6	•
ZF603050	5	13	50	6	•
ZF603060	6	15	50	6	•
ZF603070	7	18	60	8	•
ZF603080	8	18	60	8	•
ZF604090	9	22	70	10	•
ZF604100	10	22	70	10	•
ZF604110	11	26	75	12	•
ZF604120	12	26	75	12	•
ZF604130	13	32	85	14	•
ZF604140	14	32	85	14	•
ZF604150	15	35	90	16	•
ZF604160	16	35	90	16	•
ZF604180	18	44	100	18	•
ZF604200	20	44	100	20	•
ZF605250	25	50	120	25	•
ZF606320	32	70	150	32	•

■ Tolerance μm = 1/1000mm

Tolerance \ Dia.	from 1 to 3	over 3 to 6	over 6 to 10	over 10 to 18	over 18 to 30
Cutting Edge(h10)	0 -40	0 -48	0 -58	0 -70	0 -84
Shank(h6)	0 -6	0 -8	0 -9	0 -11	0 -13

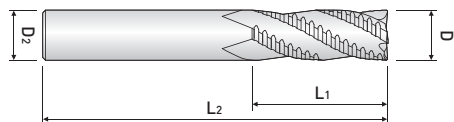

**3~5 FLUTE, ROUGHING END MILL - FINE Pitch
DIN6527L / DIN6535-HA, DIN6535-HB**

- Designed for machine tool steel, alloy steel, mold steel and other highly hardened materials.
- High velocity milling of hardened steels.
- For dry and wet milling.
- Fast chip ejection.

ZF61series



EDP. No.		Dia.	L ₁	L ₂	D ₂	STOCK
PLAIN SHANK	FLAT SHANK					
ZF613040	ZF613040F	4	10	50	6	•
ZF613050	ZF613050F	5	13	50	6	•
ZF613060	ZF613060F	6	16	57	6	•
ZF613070	ZF613070F	7	16	63	8	•
ZF613080	ZF613080F	8	16	63	8	•
ZF614090	ZF614090F	9	19	72	10	•
ZF614100	ZF614100F	10	22	72	10	•
ZF614120	ZF614120F	12	26	83	12	•
ZF614140	ZF614140F	14	32	83	14	•
ZF614160	ZF614160F	16	35	92	16	•
ZF614180	ZF614180F	18	40	100	18	•
ZF614200	ZF614200F	20	44	104	20	•
ZF615250	ZF615250F	25	50	120	25	•

■ Tolerance

Tolerance	Dia.	μm = 1/1000mm				
		from 1 to 3	over 3 to 6	over 6 to 10	over 10 to 18	over 18 to 30
Cutting Edge(h10)	0	0	0	0	0	
	-40	-48	-58	-70	-84	
Shank(h6)	0	0	0	0	0	
	-6	-8	-9	-11	-13	

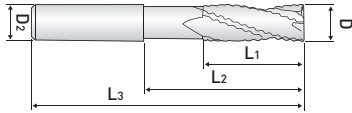

3 FLUTE, Z - AXIS ROUGHING END MILL

- Reducing cycle time by 1 pass operating from Z-axis to slotting.
- Preventing the working interruption as Neck type.

PK503 ...series



EDP. No.	D	L ₁	L ₂	L ₃	D ₂	Z	STOCK
PK503060	6	9	15	57	6	3	•
PK503080	8	12	20	63	8		•
PK503100	10	15	25	72	10		•
PK503120	12	18	30	83	12		•
PK503140	14	21	35	83	14		•
PK503160	16	24	40	92	16		•
PK503200	20	30	50	104	20		•

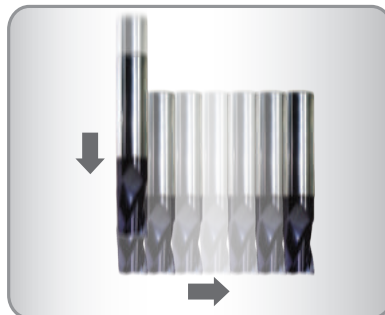

■ Tolerance μm = 1/1000mm













Tolerance \ Dia.	from 1 to 3	over 3 to 6	over 6 to 10	over 10 to 18	over 18 to 30
Cutting Edge(d11)	-20 -85	-30 -105	-40 -150	-50 -180	-65 -225
Shank(h6)	0 -6	0 -8	0 -9	0 -11	0 -13

Zamus Thunder Series



Zamus Thunder Series



EDP. No.	APPEARANCE	FEATURE	STOCK	PAGE
DB312 ...series		2 FLUTE, LONG LENGTH, BALL NOSE	•	183
DB342 ...series		2 FLUTE, BALL NOSE with TAPER NECK	•	184
ZE302 ...series		2 FLUTE, REGULAR LENGTH	•	185
ZE304 ...series		4 FLUTE, REGULAR LENGTH	•	186
ZE322 ...series		2 FLUTE, LONG LENGTH	•	187
ZE324 ...series		4 FLUTE, LONG LENGTH	•	188
ZR322series		2 FLUTE, CORNER RADIUS LONG LENGTH	•	189
ZR324series		4 FLUTE, CORNER RADIUS LONG LENGTH	•	190
ZR304H ...series		4 FLUTE, 45° HELIX STUB CUT LENGTH, CORNER RADIUS with EXTENDED NECK		191
ZR324H ...series		4 FLUTE, 45° HELIX STUB CUT LENGTH, CORNER RADIUS with LONG SHANK		192
TX302...series		2 FLUTE, REGULAR LENGTH	•	193
TX304...series		4 FLUTE, REGULAR LENGTH	•	194

Zamus Thunder Series



EDP. No.	APPEARANCE	FEATURE	STOCK	PAGE
TX304H...series		4 FLUTE, 45° HELIX, REGULAR LENGTH		195
TXB302...series		2 FLUTE, REGULAR LENGTH, BALL NOSE	•	196
TXB304...series		4 FLUTE, REGULAR LENGTH, BALL NOSE	•	197
TX202...series		2 FLUTE, SHORT LENGTH	•	198
TX222...series		2 FLUTE, LONG LENGTH	•	199
TX204...series		4 FLUTE, SHORT LENGTH	•	200
TX224...series		4 FLUTE, LONG LENGTH	•	201
TXB202...series		2 FLUTE, REGULAR LENGTH, BALL NOSE	•	202
TXB222...series		2 FLUTE, LONG LENGTH, BALL NOSE	•	203
TXB232...series		2 FLUTE, LONG REACH, BALL NOSE	•	204
TXB204...series		4 FLUTE, REGULAR LENGTH, BALL NOSE	•	205

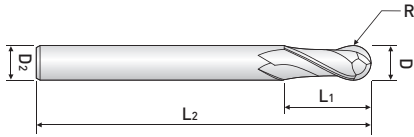

2 FLUTE, LONG LENGTH, BALL NOSE

- Designed to machine tool steel, alloy steel, mold steel and other high hardened materials.
- Suitable for copy milling.

DB312 ...series

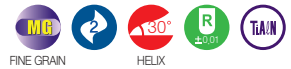

EDP. No.	Dia.	R	L ₁	L ₂	D ₂	STOCK
DB312010S4	1	0.5	2.5	50	4	•
DB312010					6	•
DB312012	1.2	0.6	3	50	6	•
DB312015	1.5	0.75	4	50	6	•
DB312020S4	2	1	5	50	4	•
DB312020					6	•
DB312025	2.5	1.25	6	60	6	•
DB312030S3	3	1.5	8	60	3	•
DB312030S4					4	•
DB312030					6	•
DB312035	3.5	1.75	8	70	6	•
DB312040S4	4	2	8	70	4	•
DB312040					6	•
DB312045	4.5	2.25	8	70	6	•
DB312050	5	2.5	10	80	6	•
DB312055	5.5	2.75	10	80	6	•
DB312060S	6	3	12	60	6	•
DB312060				90		•
DB312065	6.5	3.25	12	90	8	•
DB312070	7	3.5	14	90	8	•
DB312080S	8	4	14	60	8	•
DB312080				100		•
DB312090	9	4.5	18	100	10	•
DB312100S	10	5	18	60	10	•
DB312100				100		•
DB312120	12	6	22	110	12	•
DB312140	14	7	26	110	14	•
DB312160	16	8	30	140	16	•
DB312180	18	9	34	140	18	•
DB312200	20	10	38	160	20	•

■ Tolerance

Mill Dia. (mm)	Shank Dia.
0 ~ -0,02	h6

※ Items can be changed for quality improvement without notice.

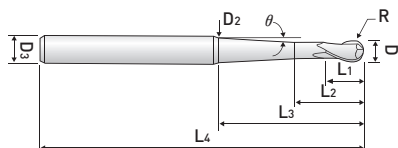

2 FLUTE, BALL NOSE with TAPER NECK

- Suitable for deep slotting machining performance as long size shape with taper neck.

DB342series



EDP. No.	D	R	L ₁	L ₂	L ₃	L ₄	D ₂	D ₃	θ	STOCK
DB34201015	1	0.5	2	4	23	60	2	6	1°30'	•
4.3							5°		•	
5							3°		•	
DB34202015	2	1	4	6	23	60	2.9	6	1°30'	•
5							5°		•	
5.7							3°		•	
DB34202030	3	1.5	6	8	32	70	5.6	6	3°	•
5.3							1°30'		•	
6							3°		•	
DB34204030	4	2	8	10	28	70	6	6	3°	•
49					90	1°30'			•	
DB34205030	5	2.5	10	12	41	90	8	8	3°	•
61					110	1°30'			•	
DB34206030	6	3	12	15	34	90	8	8	3°	•
53					110	1°30'			•	
DB34208030	8	4	14	17	36	100	10	10	3°	•
55					120	1°30'			•	
DB34210030	10	5	18	21	40	110	12	12	3°	•
59					130	1°30'			•	
DB34212030	12	6	22	25	63	140	16	16	3°	•
83					160	1°30'			•	

■ Tolerance

Mill Dia. (mm)	Shank Dia.
0 ~ -0.02	h6

※Items can be changed for quality improvement without notice.

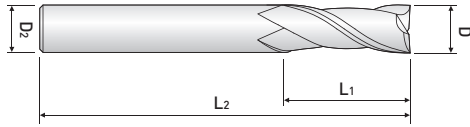

2 FLUTE, REGULAR LENGTH

- Designed to machine tool steel, alloy steel, mold steel and other high hardened materials.

ZE302 ...series



EDP. No.	Dia.	L ₁	L ₂	D ₂	STOCK
ZE302010	1	2.5	40	6	•
ZE302015	1.5	4	40	6	•
ZE302020	2	6	40	6	•
ZE302025	2.5	8	40	6	•
ZE302030	3	8	45	6	•
ZE302035	3.5	10	45	6	•
ZE302040	4	11	45	6	•
ZE302045	4.5	11	45	6	•
ZE302050	5	13	50	6	•
ZE302055	5.5	13	50	6	•
ZE302060	6	13	50	6	•
ZE302065	6.5	16	60	8	•
ZE302070	7	16	60	8	•
ZE302075	7.5	16	60	8	•
ZE302080	8	19	60	8	•
ZE302085	8.5	19	70	10	•
ZE302090	9	19	70	10	•
ZE302095	9.5	19	70	10	•
ZE302100	10	22	70	10	•
ZE302105	10.5	22	75	12	•
ZE302110	11	22	75	12	•
ZE302115	11.5	22	75	12	•
ZE302120	12	26	75	12	•
ZE302130	13	26	80	12	•
ZE302140	14	26	80	14	•
ZE302150	15	32	90	16	•
ZE302160	16	32	90	16	•
ZE302180	18	32	100	18	•
ZE302200	20	38	100	20	•

■ Tolerance

Mill Dia, (mm)	Shank Dia,
0 ~ -0,02	h6

※Items can be changed for quality improvement without notice.

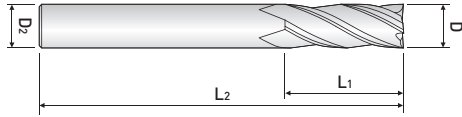

4 FLUTE, REGULAR LENGTH

- Designed to machine tool steel, alloy steel, mold steel and other high hardened materials.

ZE304 ...series



EDP. No.	Dia.	L ₁	L ₂	D ₂	STOCK
ZE304020	2	6	40	6	•
ZE304025	2.5	8	40	6	•
ZE304030	3	8	45	6	•
ZE304035	3.5	10	45	6	•
ZE304040	4	11	45	6	•
ZE304045	4.5	11	45	6	•
ZE304050	5	13	50	6	•
ZE304055	5.5	13	50	6	•
ZE304060	6	13	50	6	•
ZE304065	6.5	16	60	8	•
ZE304070	7	16	60	8	•
ZE304075	7.5	16	60	8	•
ZE304080	8	19	60	8	•
ZE304085	8.5	19	70	10	•
ZE304090	9	19	70	10	•
ZE304095	9.5	19	70	10	•
ZE304100	10	22	70	10	•
ZE304105	10.5	22	75	12	•
ZE304110	11	22	75	12	•
ZE304115	11.5	22	75	12	•
ZE304120	12	26	75	12	•
ZE304130	13	26	80	12	•
ZE304140	14	26	80	14	•
ZE304150	15	32	90	16	•
ZE304160	16	32	90	16	•
ZE304180	18	32	100	18	•
ZE304200	20	38	100	20	•

■ Tolerance

Mill Dia. (mm)	Shank Dia.
0 ~ -0.02	h6

※Items can be changed for quality improvement without notice.

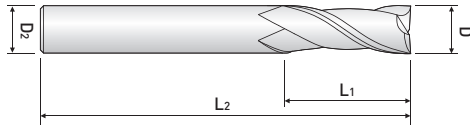

2 FLUTE, LONG & EXTRA LONG LENGTH

- Designed to machine tool steel, alloy steel, mold steel and other high hardened materials.

ZE322 ...series



EDP. No.	Dia.	L ₁	L ₂	D ₂	STOCK
ZE322030	3	15	60	6	•
ZE322031		20	70		•
ZE322030S			100	3	•
ZE322040	4	15	60	6	•
ZE322041		20	70		•
ZE322040S			100	4	•
ZE322050	5	20	60	6	•
ZE322051			80		•
ZE322052		25	100		•
ZE322060	6	20	80	6	•
ZE322061		30	100		•
ZE322062		40	150		•
ZE322080	8	30	90	8	•
ZE322081		35	100		•
ZE322082		40	150		•
ZE322100	10	30	90	10	•
ZE322101		35	100		•
ZE322102		45	150		•
ZE322103		55	180		•
ZE322120	12	30	90	12	•
ZE322121		40	110		•
ZE322122		50	150		•
ZE322123		60	200		•
ZE322140	14	40	120	14	•
ZE322141		60	150		•
ZE322160	16	50	140	16	•
ZE322161		70	160		•
ZE322162		80	200		•
ZE322180	18	50	140	18	•
ZE322200	20	60	150	20	•
ZE322201		100	200		•
ZE322202		130	250		•

■ Tolerance

Mill Dia, (mm)	Shank Dia,
0 ~ -0,03	h6

※Items can be changed for quality improvement without notice.

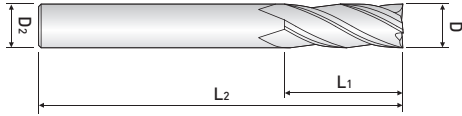

4 FLUTE, LONG & EXTRA LONG LENGTH

- Designed to machine tool steel, alloy steel, mold steel and other high hardened materials.

ZE324 ...series



EDP. No.	Dia.	L ₁	L ₂	D ₂	STOCK
ZE324030	3	15	60	6	•
ZE324031		20	70		
ZE324030S			100	3	
ZE324040	4	15	60	6	•
ZE324041		20	70		
ZE324040S			100	4	
ZE324050	5	20	60	6	•
ZE324051			80		
ZE324052		25	100		
ZE324060	6	20	80	6	•
ZE324061		30	100		
ZE324062		40	150		
ZE324080	8	30	90	8	•
ZE324081		35	100		
ZE324082		40	150		
ZE324100	10	30	90	10	•
ZE324101		35	100		
ZE324102		45	150		
ZE324103		55	180		
ZE324120	12	30	90	12	•
ZE324121		40	110		
ZE324122		50	150		
ZE324123		60	200		
ZE324140	14	40	120	14	•
ZE324141		60	150		
ZE324160	16	50	140	16	•
ZE324161		70	160		
ZE324162		80	200		
ZE324180	18	50	140	18	•
ZE324200	20	60	150	20	•
ZE324201		100	200		
ZE324202		130	250		

■ Tolerance

Mill Dia. (mm)	Shank Dia.
0 ~ -0,03	h6

※Items can be changed for quality improvement without notice.

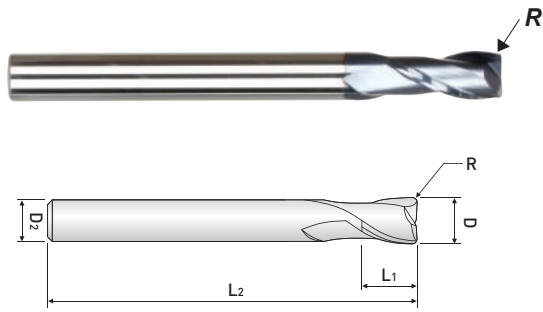

2 FLUTE, CORNER RADIUS LONG LENGTH

- Designed to machine tool steel, alloy steel mold steel and other high hardened materials.
- TiALN coated for high wear resistance.

ZR322series

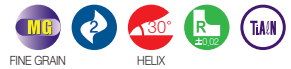

EDP. No.	Dia.	R	L ₁	L ₂	D ₂	STOCK
ZR3220302	3	0.2	8	60	4	•
ZR3220302		0.3			6	
ZR3220303		0.5			4	
ZR3220305					6	
ZR3220305					6	
ZR3220402	4	0.2	11	70	4	•
ZR3220402		0.3			6	
ZR3220403		0.5			4	
ZR3220405					6	
ZR3220405					4	
ZR3220410		1.0			6	
ZR3220502	5	0.2	13	80	6	•
ZR3220503		0.3				
ZR3220505		0.5				
ZR3220510		1.0				
ZR3220602	6	0.2	13	90	6	•
ZR3220603		0.3				
ZR3220605		0.5				
ZR3220610		1.0				
ZR3220803	8	0.3	19	100	8	•
ZR3220805		0.5				
ZR3220810		1.0				
ZR3220815		1.5				
ZR3220820		2.0				
ZR3221003	10	0.3	22	100	10	•
ZR3221005		0.5				
ZR3221010		1.0				
ZR3221015		1.5				
ZR3221020		2.0				
ZR3221025	2.5					
ZR3221205	12	0.5	26	110	12	•
ZR3221210		1.0				
ZR3221215		1.5				
ZR3221220		2.0				
ZR3221225		2.5				
ZR3221230		3.0				

■ Tolerance

Mill Dia. (mm)	Shank Dia.
0 ~ -0,03	h6

※ Items can be changed for quality improvement without notice.

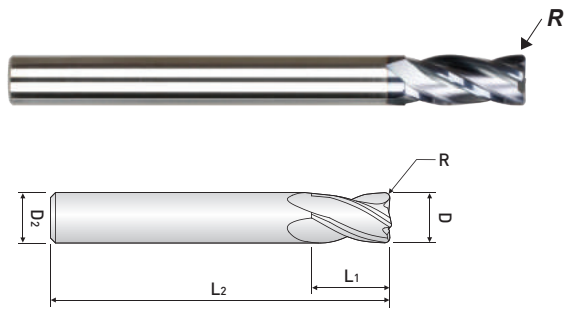

4 FLUTE, CORNER RADIUS LONG LENGTH

- Designed to machine tool steel, alloy steel mold steel and other high hardened materials.
- TiALN coated for high wear resistance.

ZR324series

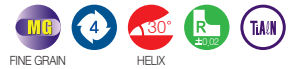

EDP. No.	Dia.	R	L ₁	L ₂	D ₂	STOCK
ZR3240302	3	0.2	8	60	4	•
ZR3240302					6	
ZR3240303		0.3			6	
ZR3240305		0.5			4	
ZR3240305					6	
ZR3240402	4	0.2	11	70	4	•
ZR3240402		6				
ZR3240403		0.3			6	
ZR3240405		0.5			4	
ZR3240405					6	
ZR3240410		4			6	
ZR3240410	1.0	6				
ZR3240502	5	0.2	13	80	6	•
ZR3240503		0.3				
ZR3240505		0.5				
ZR3240510		1.0				
ZR3240602	6	0.2	13	90	6	•
ZR3240603		0.3				
ZR3240605		0.5				
ZR3240610		1.0				
ZR3240803	8	0.3	19	100	8	•
ZR3240805		0.5				
ZR3240810		1.0				
ZR3240815		1.5				
ZR3240820		2.0				
ZR3241003	10	0.3	22	100	10	•
ZR3241005		0.5				
ZR3241010		1.0				
ZR3241015		1.5				
ZR3241020		2.0				
ZR3241025	2.5					
ZR3241205	12	0.5	26	110	12	•
ZR3241210		1.0				
ZR3241215		1.5				
ZR3241220		2.0				
ZR3241225		2.5				
ZR3241230		3.0				

■ Tolerance

Mill Dia. (mm)	Shank Dia.
0 ~ -0.03	h6

※Items can be changed for quality improvement without notice.

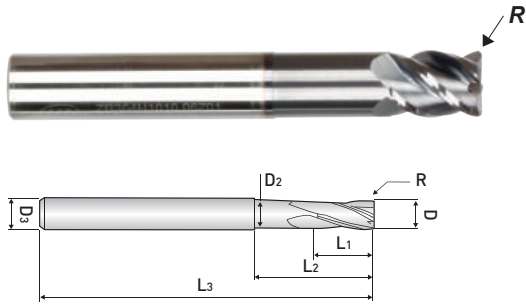

4 FLUTE, 45° HELIX STUB CUT LENGTH,
CORNER RADIUS with EXTENDED NECK

- Designed for high hardened materials up to HRc 45.
- Suitable for high speed machining.

ZR304H ...series

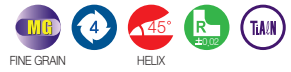

EDP. No.	D	R	L ₁	L ₂	L ₃	D ₂	D ₃	STOCK
ZR304H0303	3	0.3	4	12	55	2.8	6	
ZR304H0305		0.5						
ZR304H0403	4	0.3	5	16	55	3.8	6	
ZR304H0405		0.5						
ZR304H0605	6	0.5	7	20	60	5.8	6	
ZR304H0610		1.0						
ZR304H0805	8	0.5	10	25	65	7.8	8	
ZR304H0810		1.0						
ZR304H1005	10	0.5	12	30	70	9.8	10	
ZR304H1010		1.0						
ZR304H1015		1.5						
ZR304H1020		2.0						
ZR304H1205	12	0.5	15	30	80	11.8	12	
ZR304H1210		1.0						
ZR304H1215		1.5						
ZR304H1220		2.0						

※ These tools are manufactured based on order received.

■ Tolerance

Mill Dia, (mm)	Shank Dia,
0 ~ -0,03	h6

※ Items can be changed for quality improvement without notice.

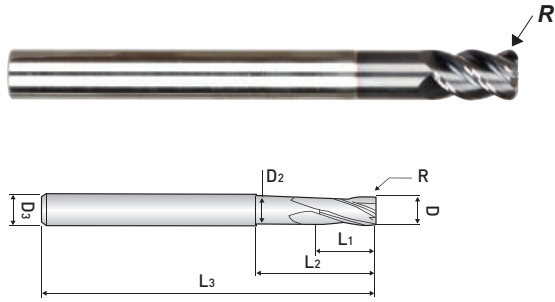

4 FLUTE, 45° HELIX STUB CUT LENGTH,
CORNER RADIUS LONG SHANK

- Designed for high hardened materials up to HRc 45.
- Suitable for high speed machining.

ZR324H ...series

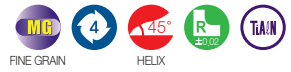

EDP. No.	D	R	L ₁	L ₂	L ₃	D ₂	D ₃	STOCK
ZR324H0605	6	0.5	9	20	90	5.8	6	
ZR324H0610		1.0						
ZR324H0805	8	0.5	12	25	100	7.8	8	
ZR324H0810		1.0						
ZR324H1005	10	0.5	15	32	100	9.8	10	
ZR324H1010		1.0						
ZR324H1015		1.5						
ZR324H1020		2.0						
ZR324H1205	12	0.5	18	38	110	11.8	12	
ZR324H1210		1.0						
ZR324H1215		1.5						
ZR324H1220		2.0						

※ These tools are manufactured based on order received.

■ Tolerance

Mill Dia. (mm)	Shank Dia.
0 ~ -0.03	h6

※ Items can be changed for quality improvement without notice.

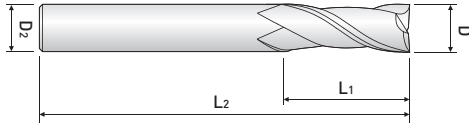

2 FLUTE, REGULAR LENGTH

- Designed to machine tool steel, alloy steel, mold steel and other high hardened materials.
- Excellent high-performance Endmills.

TX302...series



EDP. No.	Dia.	L ₁	L ₂	D ₂	STOCK
TX302010	1	3	50	4	•
TX302015	1.5	4	50	4	•
TX302020	2	6	50	4	•
TX302025	2.5	8	50	4	•
TX302030	3	9	50	4	•
TX302040	4	11	50	4	•
TX302050	5	13	50	6	•
TX302060	6	16	50	6	•
TX302070	7	16	60	8	•
TX302080	8	19	60	8	•
TX302090	9	19	60	10	•
TX302100	10	25	75	10	•
TX302120	12	30	75	12	•
TX302140	14	32	75	14	•
TX302160	16	32	100	16	•
TX302180	18	32	100	18	•
TX302200	20	38	100	20	•

■ Tolerance μm = 1/1000mm

Tolerance \ Dia.	from 1 to 3	over 3 to 6	over 6 to 10	over 10 to 18	over 18 to 30
Cutting Edge(d11)	-14 -28	-20 -38	-25 -47	-32 -59	-40 -73
Shank(h6)	0 -6	0 -8	0 -9	0 -11	0 -13

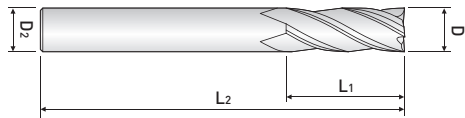

4 FLUTE, REGULAR LENGTH

- Designed to machine tool steel, alloy steel, mold steel and other high hardened materials.
- Excellent high-performance Endmills.

TX304...series



EDP. No.	Dia.	L ₁	L ₂	D ₂	STOCK
TX304010	1	3	50	4	•
TX304015	1.5	4	50	4	•
TX304020	2	6	50	4	•
TX304025	2.5	8	50	4	•
TX304030	3	9	50	4	•
TX304040	4	11	50	4	•
TX304050	5	13	50	6	•
TX304060	6	16	50	6	•
TX304070	7	16	60	8	•
TX304080	8	19	60	8	•
TX304090	9	19	60	10	•
TX304100	10	25	75	10	•
TX304120	12	30	75	12	•
TX304140	14	32	75	14	•
TX304160	16	32	100	16	•
TX304180	18	32	100	18	•
TX304200	20	38	100	20	•

■ Tolerance μm = 1/1000mm

Tolerance	Dia.	from 1 to 3	over 3 to 6	over 6 to 10	over 10 to 18	over 18 to 30
Cutting Edge(d11)		-14	-20	-25	-32	-40
		-28	-38	-47	-59	-73
Shank(h6)		0	0	0	0	0
		-6	-8	-9	-11	-13

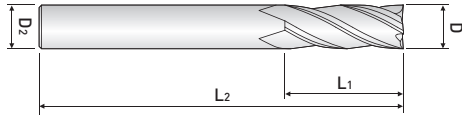

4 FLUTE, 45° HELIX, REGULAR LENGTH

- Designed to machine tool steel, alloy steel, mold steel and other high hardened materials.
- Excellent high-performance Endmills.

TX304H ...series



EDP. No.	Dia.	L ₁	L ₂	D ₂	STOCK
TX304H030	3	8	50	6	
TX304H040	4	11	50	6	
TX304H050	5	13	50	6	
TX304H060	6	13	50	6	
TX304H080	8	19	60	8	
TX304H100	10	22	70	10	
TX304H120	12	26	75	12	
TX304H130	13	26	80	12	
TX304H140	14	26	80	14	
TX304H160	16	32	90	16	
TX304H180	18	32	100	18	
TX304H200	20	38	100	20	

※ These tools are manufactured based on order received.

■ Tolerance μm = 1/1000mm

Tolerance \ Dia.	from 1 to 3	over 3 to 6	over 6 to 10	over 10 to 18	over 18 to 30
Cutting Edge(d11)	-14 -28	-20 -38	-25 -47	-32 -59	-40 -73
Shank(h6)	0 -6	0 -8	0 -9	0 -11	0 -13

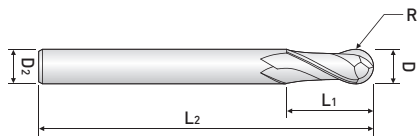

2FLUTE, REGULAR LENGTH, BALL NOSE

- Designed to machine tool steel, alloy, mold steel and other high hardened material.
- Suitable to profile processing.

TXB302...series



EDP. No.	Dia.	R	L ₁	L ₂	D ₂	STOCK
TXB302010	1	0.5	2	50	4	•
TXB302015	1.5	0.75	3	50	4	•
TXB302020	2	1	4	50	4	•
TXB302025	2.5	1.25	6	50	4	•
TXB302030	3	1.5	6	50	4	•
TXB302040	4	2	8	50	4	•
TXB302050	5	2.5	10	50	6	•
TXB302060	6	3	12	50	6	•
TXB302080	8	4	14	60	8	•
TXB302100	10	5	18	75	10	•
TXB302120	12	6	22	75	12	•
TXB302140	14	7	32	75	14	•
TXB302160	16	8	32	100	16	•
TXB302180	18	9	32	100	18	•
TXB302200	20	10	38	100	20	•

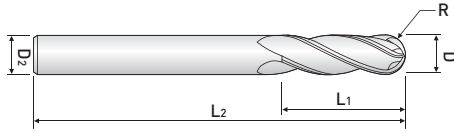

4 FLUTE, REGULAR LENGTH, BALL NOSE

- Designed to machine tool steel, alloy steel, mold steel and other high hardened materials.
- Excellent workpiece finishes.

TXB304...series

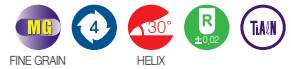

EDP. No.	Dia.	R	L ₁	L ₂	D ₂	STOCK
TXB304010	1	0.5	2	50	4	•
TXB304015	1.5	0.75	3	50	4	•
TXB304020	2	1	4	50	4	•
TXB304030	3	1.5	6	50	4	•
TXB304040	4	2	8	50	4	•
TXB304050	5	2.5	10	50	6	•
TXB304060	6	3	12	50	6	•
TXB304080	8	4	14	60	8	•
TXB304100	10	5	18	75	10	•
TXB304120	12	6	22	75	12	•
TXB304140	14	7	32	75	14	•
TXB304160	16	8	32	100	16	•
TXB304180	18	9	32	100	18	•
TXB304200	20	10	38	100	20	•

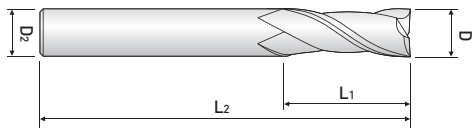

2 FLUTE, SHORT LENGTH

- Designed to machine tool steel, alloy steel, mold steel and other high hardened materials.
- Excellent workpiece finishes.

TX20...series



EDP. No.	Dia.	L ₁	L ₂	D ₂	STOCK
TX202010	1	3	39	3	•
TX202015	1.5	5	39	3	•
TX202020	2	7	39	3	•
TX202025	2.5	8	39	3	•
TX202030	3	10	39	3	•
TX202040	4	14	51	4	•
TX202050	5	16	51	5	•
TX202060	6	19	64	6	•
TX202080	8	21	64	8	•
TX202100	10	25	70	10	•
TX202120	12	25	76	12	•
TX202160	16	32	89	16	•
TX202200	20	38	102	20	•

■ Tolerance μm=1/1000mm

Tolerance \ Dia.	from 1 to 3	over 3 to 6	over 6 to 10	over 10 to 18	over 18 to 30
Cutting Edge(d11)	-14 -28	-20 -38	-25 -47	-32 -59	-40 -73
Shank(h6)	0 -6	0 -8	0 -9	0 -11	0 -13

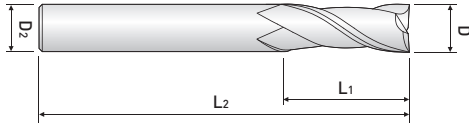

2 FLUTE, LONG LENGTH

- Designed to machine tool steel, alloy steel, mold steel and other high hardened materials.
- Excellent workpiece finishes.

TX222...series



EDP. No.	Dia.	L ₁	L ₂	D ₂	STOCK
TX222030	3	20	60	3	•
TX222040	4	20	60	4	•
TX222050	5	25	75	5	•
TX222060	6	30	75	6	•
TX222080	8	30	75	8	•
TX222100	10	40	100	10	•
TX222120	12	45	100	12	•
TX222140	14	45	100	14	•
TX222160	16	45	100	16	•
TX222180	18	45	100	18	•
TX222200	20	45	100	20	•

■ Tolerance

μm = 1/1000mm

Tolerance \ Dia.	from 1 to 3	over 3 to 6	over 6 to 10	over 10 to 18	over 18 to 30
Cutting Edge(d11)	-14 -28	-20 -38	-25 -47	-32 -59	-40 -73
Shank(h6)	0 -6	0 -8	0 -9	0 -11	0 -13

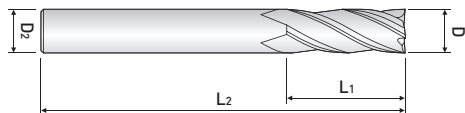

4 FLUTE, SHORT LENGTH

- Designed to machine tool steel, alloy steel, mold steel and other high hardened materials.
- Excellent workpiece finishes.

TX204...series



EDP. No.	Dia.	L ₁	L ₂	D ₂	STOCK
TX204010	1	3	39	3	•
TX204015	1.5	5	39	3	•
TX204020	2	7	39	3	•
TX204025	2.5	8	39	3	•
TX204030	3	10	39	3	•
TX204040	4	14	51	4	•
TX204050	5	16	51	5	•
TX204060	6	19	64	6	•
TX204080	8	21	64	8	•
TX204100	10	25	70	10	•
TX204120	12	25	76	12	•
TX204160	16	32	89	16	•
TX204200	20	38	102	20	•

■ Tolerance

μm=1/1000mm

Tolerance \ Dia.	from 1 to 3	over 3 to 6	over 6 to 10	over 10 to 18	over 18 to 30
Cutting Edge(d11)	-14 -28	-20 -38	-25 -47	-32 -59	-40 -73
Shank(h6)	0 -6	0 -8	0 -9	0 -11	0 -13

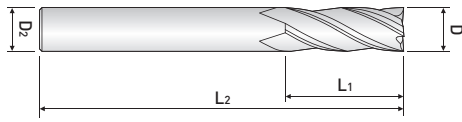

4 FLUTE, LONG LENGTH

- Designed to machine tool steel, alloy steel, mold steel and other high hardened materials.
- Excellent workpiece finishes.

TX224...series



EDP. No.	Dia.	L ₁	L ₂	D ₂	STOCK
TX224030	3	20	60	3	•
TX224040	4	20	60	4	•
TX224050	5	25	75	5	•
TX224060	6	30	75	6	•
TX224080	8	30	75	8	•
TX224100	10	40	100	10	•
TX224120	12	45	100	12	•
TX224140	14	45	100	14	•
TX224160	16	45	100	16	•
TX224180	18	45	100	18	•
TX224200	20	45	100	20	•

■ Tolerance μm = 1/1000mm

Tolerance \ Dia.	from 1 to 3	over 3 to 6	over 6 to 10	over 10 to 18	over 18 to 30
Cutting Edge(d11)	-14 -28	-20 -38	-25 -47	-32 -59	-40 -73
Shank(h6)	0 -6	0 -8	0 -9	0 -11	0 -13

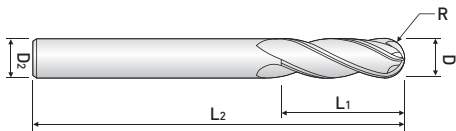

2 FLUTE, REGULAR LENGTH, BALL NOSE

- Designed to machine tool steel, alloy steel, mold steel and other high hardened materials.
- For copy-milling machines.

TXB202...series



EDP. No.	Dia.	R	L ₁	L ₂	D ₂	STOCK
TXB202010	1	0.5	3	39	3	•
TXB202015	1.5	0.75	5	39	3	•
TXB202020	2	1	7	39	3	•
TXB202025	2.5	1.25	8	39	3	•
TXB202030	3	1.5	10	39	3	•
TXB202040	4	2	14	51	4	•
TXB202050	5	2.5	16	51	5	•
TXB202060	6	3	19	64	6	•
TXB202080	8	4	21	64	8	•
TXB202100	10	5	25	70	10	•
TXB202120	12	6	25	76	12	•
TXB202160	16	8	32	89	16	•
TXB202200	20	10	38	100	20	•

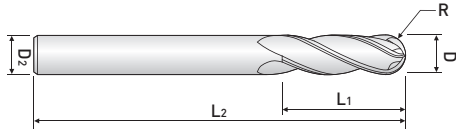

2 FLUTE, LONG LENGTH, BALL NOSE

- Designed to machine tool steel, alloy steel, mold steel and other high hardened materials.
- Excellent workpiece finishes.

TXB222...series

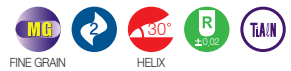

EDP. No.	Dia.	R	L ₁	L ₂	D ₂	STOCK
TXB222030	3	1.5	20	60	3	•
TXB222040	4	2	20	60	4	•
TXB222050	5	2.5	25	75	5	•
TXB222060	6	3	30	75	6	•
TXB222080	8	4	30	100	8	•
TXB222100	10	5	40	100	10	•
TXB222120	12	6	45	100	12	•
TXB222140	14	7	45	100	14	•
TXB222160	16	8	45	100	16	•
TXB222180	18	9	45	100	18	•
TXB222200	20	10	45	100	20	•

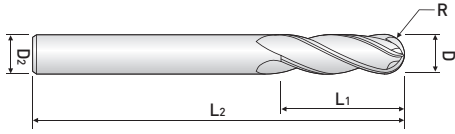

2 FLUTE, LONG REACH, BALL NOSE

- Designed to machine tool steel, alloy steel, mold steel and other high hardened materials.
- For copy-milling machines.

TXB232...series

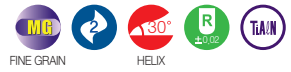

EDP. No.	Dia.	R	L ₁	L ₂	D ₂	STOCK
TXB232030	3	1.5	5	75	3	•
TXB232040	4	2	8	75	4	•
TXB232050	5	2.5	9	75	5	•
TXB232060	6	3	10	100	6	•
TXB232080	8	4	12	100	8	•
TXB232100	10	5	14	100	10	•
TXB232120	12	6	16	100	12	•
TXB232140	14	7	18	100	14	•
TXB232160	16	8	22	150	16	•
TXB232200	20	10	26	150	20	•

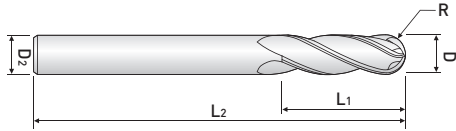

4 FLUTE, REGULAR LENGTH, BALL NOSE

- Designed to machine tool steel, alloy steel, mold steel and other high hardened materials.
- Excellent workpiece finishes.

TXB204...series

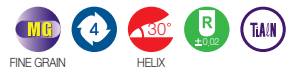

EDP. No.	Dia.	R	L ₁	L ₂	D ₂	STOCK
TXB204020	2	1	7	39	3	•
TXB204030	3	1.5	10	39	3	•
TXB204040	4	2	14	51	4	•
TXB204050	5	2.5	16	51	5	•
TXB204060	6	3	19	64	6	•
TXB204080	8	4	21	64	8	•
TXB204100	10	5	25	70	10	•
TXB204120	12	6	25	76	12	•
TXB204160	16	8	32	89	16	•
TXB204200	20	10	38	100	20	•



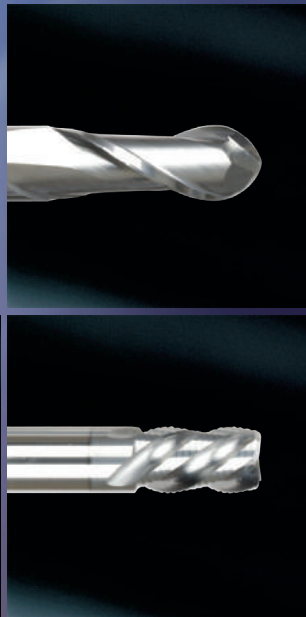

Zamus Sus-Mate Series

ENDMILL SERIES



Zamus Sus-Mate Series



EDP. No.	APPEARANCE	FEATURE	STOCK	PAGE
DS502 ...series		2 FLUTE, BALL NOSE REGULAR & LONG LENGTH	•	208
SM503 ...series		3 FLUTE, REGULAR LENGTH	•	209
SM504 ...series		4 FLUTE, REGULAR LENGTH	•	210
ZF62 ...series		4-6FLUTE, ROUGHING END MILL DIN6527 / DIN6535-HA, DIN6535-HB	•	211

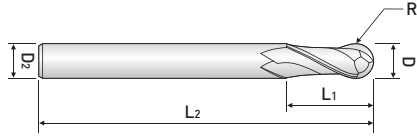

2 FLUTE, BALL NOSE REGULAR & LONG LENGTH

- Suitable for Stainless steel, Titanium, Inconel.

DS502 ...series

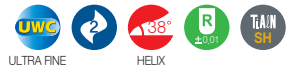

EDP. No.	Dia.	R	L ₁	L ₂	D ₂	STOCK
DS502010	1	0.5	3	50	6	•
DS502020	2	1	6	50	6	•
DS502030	3	1.5	8	50	6	•
DS502031				70		•
DS502040	4	2	10	50	6	•
DS502041				70		•
DS502050	5	2.5	13	50	6	•
DS502051				80		•
DS502060	6	3	13	50	6	•
DS502061				90		•
DS502080	8	4	19	60	8	•
DS502081				100		•
DS502100	10	5	22	70	10	•
DS502101				100		•
DS502120	12	6	26	75	12	•
DS502121				110		•

■ Tolerance

Radius (mm)	Shank Dia.
±0,01	h6

※Items can be changed for quality improvement without notice.

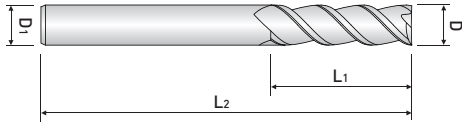

3 FLUTE, REGULAR LENGTH

- Suitable for Stainless steel, Titanium, Inconel.

SM503 ...series



EDP. No.	Dia.	L ₁	L ₂	D ₂	STOCK
SM503020	2	6	45	6	•
SM503030	3	8	45	6	•
SM503040	4	10	50	6	•
SM503050	5	13	50	6	•
SM503060	6	13	50	6	•
SM503080	8	19	60	8	•
SM503100	10	22	70	10	•
SM503120	12	26	75	12	•
SM503140	14	30	82	14	•
SM503160	16	40	100	16	•
SM503180	18	40	100	18	•
SM503200	20	40	100	20	•

■ Tolerance

Mill Dia. (mm)	Shank Dia.
± 0,01	h6

※ Items can be changed for quality improvement without notice.

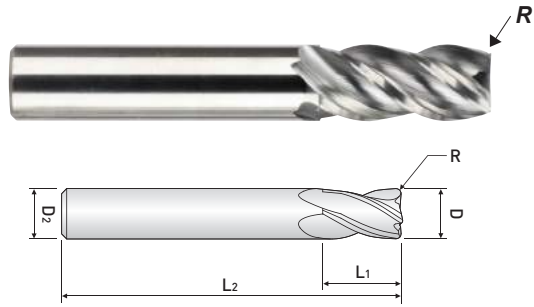

4 FLUTE, REGULAR LENGTH

- Suitable for Stainless steel, Titanium, Inconel.
- Broken Index Type.

SM504 ...series



EDP. No.	D	R	L ₁	L ₂	D ₂	STOCK
SM504020	2	0.1	6	45	6	•
SM504030	3	0.1	10	45	6	•
SM504040	4	0.2	12	50	6	•
SM504050	5	0.2	13	50	6	•
SM504060	6	0.2	13	50	6	•
SM504070	7	0.2	16	60	8	•
SM504080	8	0.2	16	60	8	•
SM504090	9	0.2	19	70	10	•
SM504100	10	0.3	22	70	10	•
SM504120	12	0.3	26	75	12	•
SM504140	14	0.3	26	82	14	•
SM504160	16	0.3	32	90	16	•
SM504180	18	0.3	32	100	18	•
SM504200	20	0.3	38	100	20	•

■ Tolerance

Mill Dia. (mm)		Shank Dia.
Diameter	Tolerance	
	0 ~ -0,02	h6
	0 ~ -0,03	

※Items can be changed for quality improvement without notice.

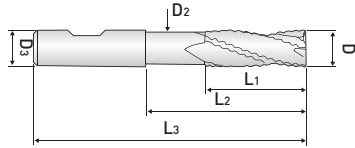

**4~6 FLUTE, ROUGHING END MILL
DIN6527 / DIN6535-HA, DIN6535-HB**

- Designed to machine tool steel, alloy steel, stainless steel and other low hardness materials.
- Fast chip ejection.

ZF62series



EDP. No.		D	L ₁	L ₂	D ₂	L ₃	D ₃	Z	STOCK
PLAIN SHANK	FLAT SHANK								
ZF624060	ZF624060F	6	7	-	-	54	6	4	•
ZF624061	ZF624061F		16	-	-	57			•
ZF624062	ZF624062F		20	5.5	57	•			
ZF624080	ZF624080F	8	9	-	-	58	8	4	•
ZF624081	ZF624081F		16	-	-	63			•
ZF624082	ZF624082F		26	7.5	63	•			
ZF624100	ZF624100F	10	14	-	-	66	10	4	•
ZF624101	ZF624101F		22	-	-	72			•
ZF624102	ZF624102F		31	9.5	72	•			
ZF624120	ZF624120F	12	16	-	-	73	12	4	•
ZF624121	ZF624121F		26	-	-	83			•
ZF624122	ZF624122F		37	11.5	83	•			
ZF625160	ZF625160F	16	22	-	-	82	16	5	•
ZF625161	ZF625161F		32	-	-	92			•
ZF625162	ZF625162F		51	15.5	100	•			
ZF626200	ZF626200F	20	26	-	-	92	20	6	•
ZF626201	ZF626201F		38	-	-	104			•
ZF626202	ZF626202F		59	19.2	110	•			

■ Tolerance μm = 1/1000mm

Tolerance \ Dia.	ø 1~ø 3	ø 3~ø 6	ø 6~ø 10	ø 10~ø 18	ø 18~ø 30
Cutting Edge(h10)	0 -40	0 -48	0 -58	0 -70	0 -84
Shank(h6)	0 -6	0 -8	0 -9	0 -11	0 -13

Zamus Copper-Mate Series

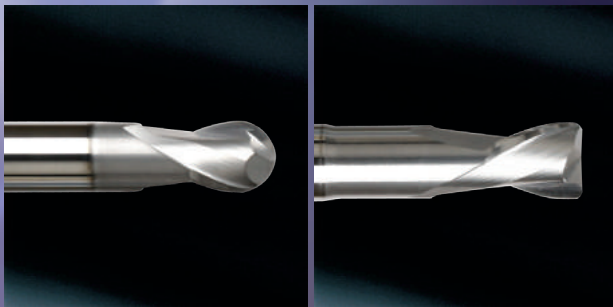

ENDMILL SERIES





Zamus Copper-Mate Series



EDP. No.	APPEARANCE	FEATURE	STOCK	PAGE
BC502series		2 FLUTE, STUB CUT LENGTH, BALL NOSE with EXTENDED NECK	•	214
RC502.....series		2 FLUTE, STUB CUT LENGTH, CORNER RADIUS with EXTENDED NECK	•	215

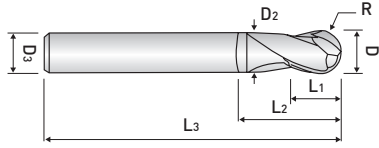

2 FLUTE, STUB CUT LENGTH,
BALL NOSE with EXTENDED NECK

- Suitable for copper & non-ferrous material.

BC502 ...series



EDP. No.	D	R	L ₁	L ₂	L ₃	D ₂	D ₃	STOCK
BC502010	1	0.5	1.5	3	50	0.8	6	•
BC502015	1.5	0.75	2	4	50	1.3	6	•
BC502020	2	1	2.5	5	50	1.8	6	•
BC502025	2.5	1.25	3	7	50	2.3	6	•
BC502030	3	1.5	4	10	60	2.8	6	•
BC502040	4	2	5	10	60	3.8	6	•
BC502050	5	2.5	6	12	60	4.8	6	•
BC502060	6	3	7	12	60	5.8	6	•
BC502061					90			
BC502080	8	4	9	15	70	7.8	8	•
BC502081				16	100			
BC502100	10	5	11	25	75	9.8	10	•
BC502101					100			
BC502120	12	6	12	25	80	11.8	12	•
BC502121					110			

■ Tolerance

Radius (mm)	Shank Dia.
±0,01	h6

※Items can be changed for quality improvement without notice.

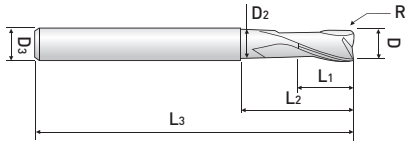

2 FLUTE, STUB CUT LENGTH,
CORNER RADIUS with EXTENDED NECK

- Suitable for copper & non-ferrous material.

RC502series



EDP. No.	D	R	L ₁	L ₂	L ₃	D ₂	D ₃	STOCK
RC5020200509	2	0.5	3	9	55	1.8	6	•
RC5020300509	3	0.5	4	9	55	2.8	6	•
RC5020300516				16				
RC5020300520				20				
RC5020400512	4	0.5	5	12	55	3.7	6	•
RC5020400516				16				
RC5020400520				20				
RC5020600520	6	0.5	7	20	60	5.5	6	•
RC5020601020		1						
RC5020800525	8	0.5	9	25	60	7.4	8	•
RC5020801025		1						
RC5021000532	10	0.5	11	32	70	9.2	10	•
RC5021001032		1						
RC5021200538	12	0.5	12	38	80	11	12	•
RC5021201038		1						

■ Tolerance

Mill Dia. (mm)		Shank Dia.
Diameter	Tolerance	
up to 6	0 ~ -0,012	h6
over 6	0 ~ -0,015	

※Items can be changed for quality improvement without notice.

Zamus Gra-Mate Series

ENDMILL SERIES

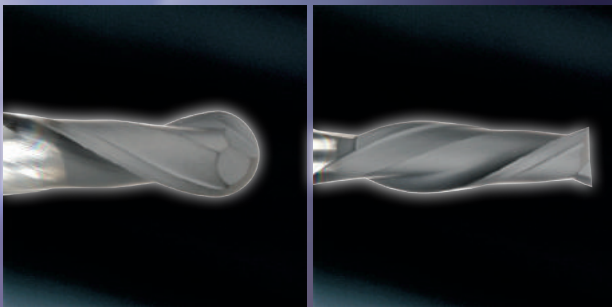

Zamus Gra-Mate Series



EDP. No.	APPEARANCE	FEATURE	STOCK	PAGE
Gseries		2 FLUTE, DIAMOND COATING BALL NOSE	•	218
GEseries		2 FLUTE, DIAMOND COATING END MILL	•	221

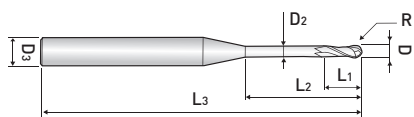

2 FLUTE, DIAMOND COATING BALL NOSE

- High performance on **graphite**, wrought aluminum, bakelite, plastics, wood, brass etc.

Gseries



EDP. No.	D	R	L ₁	L ₂	L ₃	D ₂	D ₃	STOCK
G00501003	0.5	0.25	1	3	50	0.45	4	•
G00501006				6				•
G00501010				10				•
G00601203	0.6	0.3	1.2	3	50	0.55	4	•
G00601206				6				•
G00601208				8				•
G00601210				10				•
G00601212				12				•
G0080164	0.8	0.4	1.6	4	50	0.75	4	•
G0080166				6				•
G0080168				8				•
G0100306	1	0.5	3	6	60	0.95	4	•
G0100308				8				•
G0100310				10				•
G0100312				12				•
G0100314				14				•
G0100316				16				•
G0100318				18				•
G0100320				20				•
G0120410	1.2	0.6	4	10	70	1.15	4	•
G0150510	1.5	0.75	5	10	60	1.45	4	•
G0150512				12				•
G0150516				16				•
G0150520				20				•
G0150525				25	70			•
G0150530				30				•

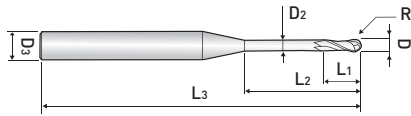

2 FLUTE, DIAMOND COATING BALL NOSE

- High performance on **graphite**, wrought aluminum, bakelite, plastics, wood, brass etc.

Gseries



EDP. No.	D	R	L ₁	L ₂	L ₃	D ₂	D ₃	STOCK							
G0200812	2	1	8	12	60	1.95	4	•							
G0200816				16				•							
G0200820				20				•							
G0200825				25	•										
G0200830				30	70			•							
G0200835				35	•										
G0200840			40	80	•										
G0201020			10		10			20	80	•					
G0201020L									100	•					
G0251020			2.5	1.25	10			20	80	2.43	4	•			
G0301216	3	1.5	12	16	60	2.9	6	•							
G0301220				20	70			•							
G0301225				25	•										
G0301230				30	80			•							
G0301235				35	•										
G0301240				40	90			•							
G0301245			45	•											
G0301525			15		25			80		4	•				
G04015S	4	2	15	-	50	-	4	•							
G04015M				-	80	-		•							
G04015L				-	120	-		•							
G0401520				3.9	6	15	20	60	3.9	6	•				
G0401525							25	70			•				
G0401530							30	80			•				
G0401535							35	•							
G0401540							40	90			•				
G0401545							45	•							
G0401550							50	100			•				
G0402030							20				30	80		4	•

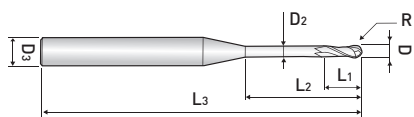

2 FLUTE, DIAMOND COATING BALL NOSE

- High performance on **graphite**, wrought aluminum, bakelite, plastics, wood, brass etc.

Gseries



EDP. No.	D	R	L ₁	L ₂	L ₃	D ₂	D ₃	STOCK		
G0503050	5	2.5	30	50	100	4.8	6	•		
G0503050L					150			•		
G06020S	6	3	20	-	70	-	6	•		
G06020M				-	100	-		•		
G06020L				-	150	-		•		
G0603050			30	50	50	100		5.8	6	•
G0603050L						150				•
G08025S						-				70
G08025M	8	4	25	-	110	-	8	•		
G08025L				-	160	-		•		
G0804060				40	60	60		110	7.8	8
G0804060L			200					•		
G10030S			-					80		
G10030M			10	5	30	-		120	-	10
G10030L	-	170				-	•			
G1005070	50	70				50	120	9.7	10	
G1005070L					200		•			
G12035S					-		80			
G12035M	12	6			35	-	130	-	12	
G12035L			-	180		-	•			
G1205575			55	75		55	130	11.7		12
G1205575L					200		•			
G1205575L					200		•			

■ Tolerance

Mill Dia. (mm)	Shank Dia.
0 ~ -0,03	h6

※Items can be changed for quality improvement without notice.

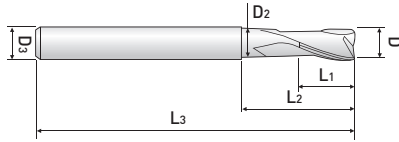

2 FLUTE, DIAMOND COATING END MILL

- High performance on **graphite**, wrought aluminum, bakelite, plastics, wood, brass etc.

GEseries



EDP. No.	D	L ₁	L ₂	L ₃	D ₂	D ₃	STOCK
GE00501006	0.5	1	6	50	0.45	4	•
GE00601206	0.6	1.2	6	50	0.55	4	•
GE00601210			10				•
GE00701506	0.7	1.5	6	50	0.65	4	•
GE00802006	0.8	2	6	50	0.75	4	•
GE0100308	1	3	8	60	0.95	4	•
GE0100310			10				•
GE0100312			12				•
GE0150412	1.5	4	12	60	1.45	4	•
GE0200612	2	6	12	60	1.95	4	•
GE0200612S6						6	•
GE0250812	2.5	8	12	60	2.43	4	•
GE0301012	3	10	12	60	2.9	4	•
GE0301016			16				•
GE0301012S6			12			6	•
GE0301016S6			16				•
GE04012S	4	12	-	60	-	6	•
GE0401216			16		3.9		•
GE0401220			20		•		
GE0501520	5	15	20	60	4.8	6	•
GE06020S	6	20	-	60	-	6	•
GE0602030			30	80	5.8		•
GE0603050			50	150			•
GE08025S	8	25	-	70	-	8	•
GE0802540			40	100	7.8		•
GE0804070			70	150			•
GE10030S	10	30	-	80	-	10	•
GE1003050			50	100	9.7		•
GE1004580			45	80			160
GE12030S	12	30	-	80	-	12	•
GE1203050			50	110	11.7		•
GE1205080			50	80			160

■ Tolerance

Mill Dia, (mm)	Shank Dia,
0 ~ -0,03	h6





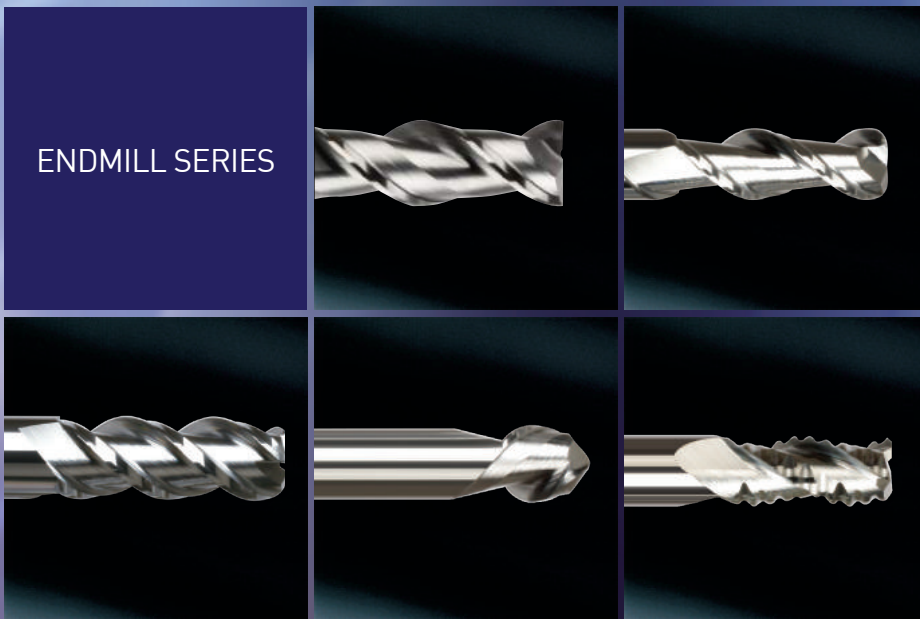

※Items can be changed for quality improvement without notice.

Zamus Al-Mate Series



Zamus Al-Mate Series

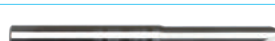

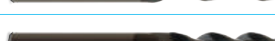
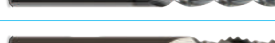
EDP. No.	APPEARANCE	FEATURE	STOCK	PAGE
AE302 ...series		2 FLUTE, LONG LENGTH - for Aluminum	•	224
AE30(2)3 ...series		3 FLUTE, LONG & EXTRA LONG LENGTH - for Aluminum	•	225
AR302 ...series		2 FLUTE, CORNER RADIUS	•	227
AR303 ...series		3 FLUTE, CORNER RADIUS	•	228
AB312 ...series		2 FLUTE, STUB CUT BALL NOSE - for Aluminum	•	229
AR502 ...series		2 FLUTE, CORNER RADIUS with D.L.C. COATED	•	230
AR503 ...series		3 FLUTE, CORNER RADIUS with D.L.C. COATED	•	231
AF303 ...series		ROUGHING END MILL - for Aluminum	•	232



2 FLUTE, LONG LENGTH - for Aluminum

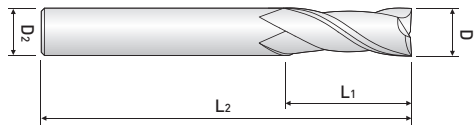

AE302 ...series



EDP. No.	Dia.	L ₁	L ₂	D ₂	STOCK
AE302010	1	3	40	4	•
AE302015	1.5	6	57	6	•
AE302020S4	2	6	40	4	•
AE302020	2	6	57	6	•
AE302025	2.5	10	57	6	•
AE302030	3	12	57	6	•
AE302035	3.5	12	57	6	•
AE302040	4	14	57	6	•
AE302050	5	16	57	6	•
AE302060	6	16	57	6	•
AE302070	7	20	63	8	•
AE302080	8	22	63	8	•
AE302090	9	25	72	10	•
AE302100	10	28	72	10	•
AE302110	11	30	80	12	•
AE302120	12	32	80	12	•
AE302130	13	35	85	14	•
AE302140	14	35	85	14	•
AE302150	15	40	90	16	•
AE302160	16	45	90	16	•
AE302180	18	45	100	18	•
AE302200	20	50	100	20	•
AE302250	25	50	120	25	•

■ Tolerance

Mill Dia. (mm)	Shank Dia.
0 ~ -0,02	h6

※Items can be changed for quality improvement without notice.



3 FLUTE, LONG & EXTRA LONG LENGTH
- for Aluminum

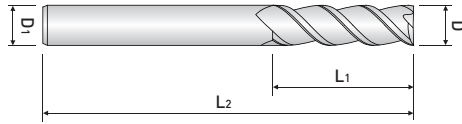

AE30(2)3 ...series



EDP. No.	Dia.	L ₁	L ₂	D ₂	STOCK
AE303010	1	3	40	6	•
AE303015	1.5	4	40	6	•
AE303020	2	6	50	6	•
AE303025	2.5	8	50	6	•
AE303030	3	12	57	6	•
AE303031		15			•
AE323030		20	62		•
AE323031		25			•
AE303040	4	14	57	6	•
AE303041		20			•
AE323040		25	62		•
AE323041		30			70
AE303050	5	16	57	6	•
AE303051		20			•
AE303052		25	62		•
AE323050		30			70
AE323051		35	•		
AE303060	6	16	57	6	•
AE303061		20			•
AE303062		25	62		•
AE303063		30			70
AE323060		35	80		
AE323061		42			90
AE303070	7	20	63	8	•
AE303080	8	22	63	8	•
AE303081		30			70
AE303082		35	80		
AE323080		40			100
AE323081		45	•		
AE303090		9	25		72

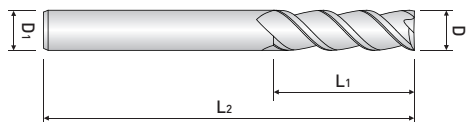

3 FLUTE, LONG & EXTRA LONG LENGTH
- for Aluminum

AE30(2)3 ...series



EDP. No.	Dia.	L ₁	L ₂	D ₂	STOCK
AE303100	10	28	72	10	•
AE303101		35	80		•
AE303102		45	100		•
AE323100		55	110		•
AE323101		65	120		•
AE303110	11	30	80	12	•
AE303120	12	32	80	12	•
AE303121		40	90		•
AE303122		45	100		•
AE303123		55	110		•
AE323120		65	120		•
AE323121		75	125		•
AE303130	13	35	85	14	•
AE303140	14	35	85	14	•
AE303150	15	40	90	16	•
AE303160	16	45	90	16	•
AE303161		55	110		•
AE303162		65	125		•
AE303163		75	130		•
AE323160		85	150		•
AE303180	18	45	100	18	•
AE303200	20	50	100	20	•
AE303201		60	110		•
AE303202		70	130		•
AE323200		80	150		•
AE323201		90	160		•
AE323202		100	160		•
AE303250	25	50	120	25	•

■ Tolerance

Mill Dia. (mm)	Shank Dia.
0 ~ -0.02	h6

※Items can be changed for quality improvement without notice.

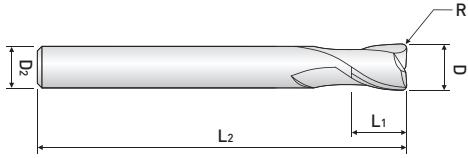

2FLUTE, REGULAR LENGTH,
CORNER RADIUS - for Aluminum

AR302 ...series



EDP. No.	Dia.	R	L ₁	L ₂	D ₂	STOCK
AR3020605	6	0.5	15	50	6	•
AR3020610		1				•
AR3020615		1.5				•
AR3020805	8	0.5	20	60	8	•
AR3020810		1				•
AR3020815		1.5				•
AR3020820		2				•
AR3021005	10	0.5	25	70	10	•
AR3021010		1				•
AR3021015		1.5				•
AR3021020		2				•
AR3021030		3				•
AR3021040		4				•
AR3021210	12	1	30	75	12	•
AR3021220		2				•
AR3021230		3				•
AR3021240		4				•
AR3021410	14	1	35	80	14	•
AR3021420		2				•
AR3021430		3				•
AR3021440		4				•
AR3021450		5				•
AR3021610	16	1	40	90	16	•
AR3021620		2				•
AR3021630		3				•
AR3021640		4				•
AR3021650		5				•
AR3022010	20	1	45	100	20	•
AR3022020		2				•
AR3022030		3				•
AR3022040		4				•
AR3022050		5				•

■ Tolerance

Mill Dia. (mm)	Shank Dia.
0 ~ -0,02	h6

※ Items can be changed for quality improvement without notice.

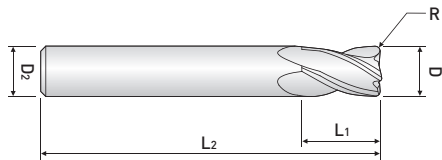

3FLUTE, REGULAR LENGTH,
CORNER RADIUS - for Aluminum

AR303 ...series



EDP. No.	R	L ₁	L ₂	D ₂	STOCK
AR3030605	0.5	15	50	6	•
AR3030610	1				•
AR3030615	1.5				•
AR3030805	0.5	20	60		•
AR3030810	1				•
AR3030815	1.5				•
AR3030820	2				•
AR3031005	0.5	25	70	10	•
AR3031010	1				•
AR3031015	1.5				•
AR3031020	2				•
AR3031030	3				•
AR3031040	4				•
AR3031210	1	30	75	12	•
AR3031220	2				•
AR3031230	3				•
AR3031240	4				•
AR3031410	1	35	80	14	•
AR3031420	2				•
AR3031430	3				•
AR3031440	4				•
AR3031450	5				•
AR3031610	1	40	90	16	•
AR3031620	2				•
AR3031630	3				•
AR3031640	4				•
AR3031650	5				•
AR3032010	1	45	100	20	•
AR3032020	2				•
AR3032030	3				•
AR3032040	4				•
AR3032050	5				•

■ Tolerance

Mill Dia. (mm)	Shank Dia.
0 ~ -0.02	h6

※Items can be changed for quality improvement without notice.

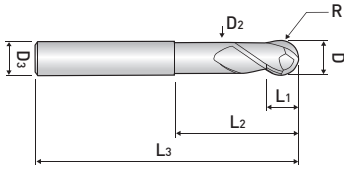

2 FLUTE, STUB CUT BALL NOSE
- for Aluminum
- Excellent cutting quality on **aluminum** & copper.

AB312 ...series



EDP. No.	D	R	L ₁	L ₂	L ₃	D ₂	D ₃	STOCK
AB312060	6	3	5.5	25	55	5.4	6	•
AB312061				40	90			•
AB312080	8	4	7	30	65	7.2	8	•
AB312081				50	100			•
AB312100	10	5	8.5	35	75	9	10	•
AB312101				50	100			•
AB312102			10	60	150			•
AB312120	12	6	10.5	40	75	11	12	•
AB312121				50	110			•
AB312122			12	60	150			•
AB312160	16	8	14	50	90	14.5	16	•
AB312161				70	150			•
AB312162			16	90	200			•
AB312200	20	10	17	50	100	18	20	•

■ Tolerance

Mill Dia, (mm)	Shank Dia,
± 0,02	h6

※ Items can be changed for quality improvement without notice.

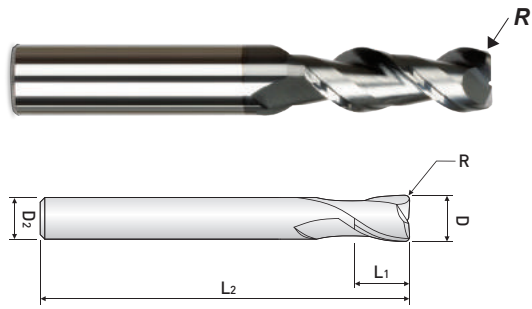

**2 FLUTE, CORNER RADIUS,
LONG LENGTH, D.L.C. COATING**

- Suitable for aluminium, aluminium alloy, copper & non-ferrous material.
- Corner radius against chipping in high speed machining.

AR502 ...series

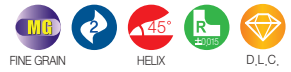

EDP. No.	Dia.	R	L ₁	L ₂	D ₂	STOCK
AR502010	1	0.05	3	40	6	•
AR502015	1.5	0.05	5	40	6	•
AR502020	2	0.1	6	40	6	•
AR502021			12	50		•
AR502030	3	0.1	10	50	6	•
AR502031			20	60		•
AR502040	4	0.1	12	50	6	•
AR502041			20	60		•
AR502050	5	0.1	15	57	6	•
AR502060	6	0.1	15	57	6	•
AR502061			22	65		•
AR502070	7	0.1	20	63	8	•
AR502080	8	0.1	20	63	8	•
AR502081			28	70		•
AR502090	9	0.1	25	72	10	•
AR502100	10	0.2	28	72	10	•
AR502101			32	80		•
AR502110	11	0.2	30	80	12	•
AR502120	12	0.2	32	80	12	•
AR502121			40	100		•

■ Tolerance

Mill Dia. (mm)	Shank Dia.
0 ~ -0.02	h6

※Items can be changed for quality improvement without notice.

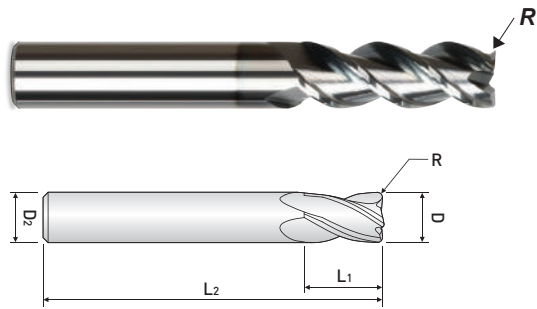

**3 FLUTE, CORNER RADIUS,
LONG LENGTH, D.L.C. COATING**

- Suitable for aluminium, aluminium alloy, copper & non-ferrous material.
- Corner radius against chipping in high speed machining.

AR503 ...series

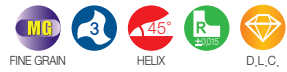

EDP. No.	Dia.	R	L ₁	L ₂	D ₂	STOCK
AR503040	4	0.5	14	57	6	•
AR503041		1	25	62		•
AR503060	6	0.5	16	57	6	•
AR503061		1	25	62		•
AR503080	8	0.5	22	63	8	•
AR503081		1	35	80		•
AR503100	10	0.5	28	72	10	•
AR503101		1	45	100		•
AR503120	12	0.5	32	80	12	•
AR503121		1	45	100		•
AR503160	16	0.5	45	90	16	•
AR503161		1	65	125		•
AR503200	20	0.5	50	100	20	•
AR503201		1	70	130		•

■ Tolerance

Mill Dia. (mm)	Shank Dia.
0 ~ -0,02	h6

※Items can be changed for quality improvement without notice.

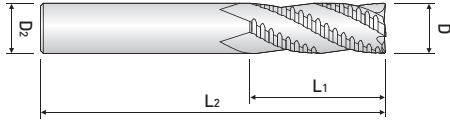

ROUGHING END MILL - for Aluminum
DIN6527L / DIN6535-HA, DIN6535-HB

AF303 ...series



EDP. No.		Dia.	L ₁	L ₂	D ₂	STOCK
PLAIN SHANK	FLAT SHANK					
AF303060	AF303060F	6	16	57	6	•
AF303070	AF303070F	7	16	63	8	•
AF303080	AF303080F	8	16	63	8	•
AF303090	AF303090F	9	19	72	10	•
AF303100	AF303100F	10	22	72	10	•
AF303120	AF303120F	12	26	83	12	•
AF303140	AF303140F	14	26	83	14	•
AF303160	AF303160F	16	32	92	16	•
AF303180	AF303180F	18	32	92	18	•
AF303200	AF303200F	20	38	104	20	•

■ Tolerance μm = 1/1000mm













Tolerance \ Dia.	from 1 to 3	over 3 to 6	over 6 to 10	over 10 to 18	over 18 to 30
Cutting Edge(h10)	0 -40	0 -48	0 -58	0 -70	0 -84
Shank(h6)	0 -6	0 -8	0 -9	0 -11	0 -13

Standard End Mill Series



Standard End Mill Series



EDP. No.	APPEARANCE	FEATURE	STOCK	PAGE
E302 ...series		2 FLUTE, REGULAR LENGTH	•	235
E304 ...series		4 FLUTE, REGULAR LENGTH	•	237
B302 ...series		2 FLUTE, BALL NOSE LONG LENGTH	•	238
BL422 ...series		2 FLUTE, BALL NOSE EXTRA LONG LENGTH	•	239
B304 ...series		4 FLUTE, BALL NOSE LONG LENGTH	•	240
E322 ...series		2 FLUTE, LONG LENGTH	•	241
E324 ...series		4 FLUTE, LONG LENGTH	•	242
EB302 ...series		2 FLUTE, REGULAR LENGTH - BRAZED TYPE	•	243
EB304 ...series		4 FLUTE, REGULAR LENGTH - BRAZED TYPE	•	244
EB322 ...series		2 FLUTE, LONG LENGTH - BRAZED TYPE	•	245
EB324 ...series		4 FLUTE, LONG LENGTH - BRAZED TYPE	•	246
BB302 ...series		2 FLUTE, BALL NOSE REGULAR LENGTH - BRAZED TYPE	•	247



2 FLUTE, REGULAR LENGTH

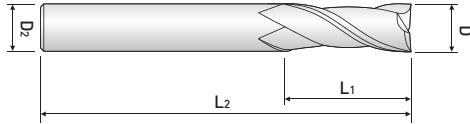

E302 ...series



EDP. No.	Dia.	L ₁	L ₂	D ₂	STOCK
E302010S4	1	3	42	4	•
E302010				6	•
E302015S4	1.5	4	42	4	•
E302015				6	•
E302020S4	2	6	42	4	•
E302020				6	•
E302025S4	2.5	8	42	4	•
E302025				6	•
E302030	3	10	50	6	•
E302035	3.5	10	50	6	•
E302040	4	12	50	6	•
E302045	4.5	14	50	6	•
E302050	5	15	50	6	•
E302055	5.5	15	50	6	•
E302060	6	15	50	6	•
E302065	6.5	18	60	8	•
E302070	7	20	60	8	•
E302075	7.5	20	60	8	•
E302080	8	20	60	8	•
E302085	8.5	23	70	10	•
E302090	9	25	70	10	•
E302095	9.5	25	70	10	•
E302100	10	25	70	10	•
E302105	10.5	28	75	12	•
E302110	11	30	75	12	•



2 FLUTE, REGULAR LENGTH

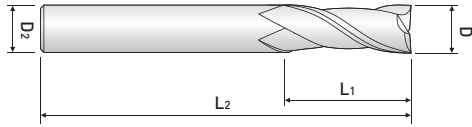

E302 ...series



EDP. No.	Dia.	L ₁	L ₂	D ₂	STOCK
E302115	11.5	30	75	12	•
E302120	12	30	75	12	•
E302130	13	35	85	14	•
E302130S16			90	16	•
E302140	14	35	85	14	•
E302140S16			90	16	•
E302150	15	40	90	16	•
E302160	16	40	90	16	•
E302180	18	45	100	18	•
E302200	20	45	100	20	•
E302250	25	50	120	25	•

■ Tolerance

Tolerance	Dia.	μm = 1/1000mm				
		from 1 to 3	over 3 to 6	over 6 to 10	over 10 to 18	over 18 to 30
Cutting Edge(h10)	0	0	0	0	0	
	-40	-48	-58	-70	-84	
Shank(h6)	0	0	0	0	0	
	-6	-8	-9	-11	-13	



4 FLUTE, REGULAR LENGTH

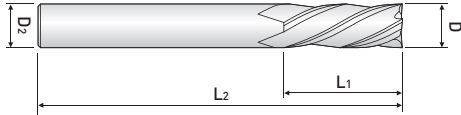

E304 ...series



EDP. No.	Dia.	L ₁	L ₂	D ₂	STOCK
E304020S4	2	6	42	4	•
E304020				6	•
E304025	2.5	8	42	6	•
E304030	3	10	50	6	•
E304035	3.5	10	50	6	•
E304040	4	12	50	6	•
E304045	4.5	14	50	6	•
E304050	5	15	50	6	•
E304055	5.5	15	50	6	•
E304060	6	15	50	6	•
E304065	6.5	18	60	8	•
E304070	7	20	60	8	•
E304075	7.5	20	60	8	•
E304080	8	20	60	8	•
E304085	8.5	23	70	10	•
E304090	9	25	70	10	•
E304095	9.5	25	70	10	•
E304100	10	25	70	10	•
E304105	10.5	28	75	12	•
E304110	11	30	75	12	•
E304115	11.5	30	75	12	•
E304120	12	30	75	12	•
E304130	13	35	85	14	•
E304130S16			90	16	•
E304140	14	35	85	14	•
E304140S16			90	16	•
E304150	15	40	90	16	•
E304160	16	40	90	16	•
E304180	18	45	100	18	•
E304200	20	45	100	20	•
E304250	25	50	120	25	•

■ Tolerance μm = 1/1000mm

Tolerance \ Dia.	from 1 to 3	over 3 to 6	over 6 to 10	over 10 to 18	over 18 to 30
Cutting Edge(h10)	0 -40	0 -48	0 -58	0 -70	0 -84
Shank(h6)	0 -6	0 -8	0 -9	0 -11	0 -13



2 FLUTE, BALL NOSE LONG LENGTH

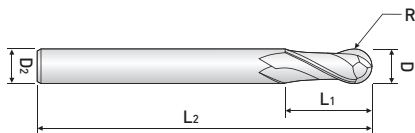

B302 ...series



EDP. No.	Dia.	R	L ₁	L ₂	D ₂	STOCK
B302010	1	0.5	3	50	6	•
B302015	1.5	0.75	4	50	6	•
B302020	2	1	6	60	6	•
B302025	2.5	1.25	6	60	6	•
B302030	3	1.5	8	70	6	•
B302035	3.5	1.75	8	70	6	•
B302040	4	2	8	70	6	•
B302045	4.5	2.25	10	70	6	•
B302050	5	2.5	12	80	6	•
B302055	5.5	2.75	12	80	6	•
B302060	6	3	12	90	6	•
B302065	6.5	3.25	12	90	8	•
B302070	7	3.5	20	90	8	•
B302080	8	4	20	100	8	•
B302090	9	4.5	25	100	10	•
B302100	10	5	25	100	10	•
B302110	11	5.5	30	110	12	•
B302120	12	6	30	110	12	•
B302130	13	6.5	35	120	14	•
B302140	14	7	35	120	14	•
B302150	15	7.5	40	140	16	•
B302160	16	8	40	140	16	•
B302180	18	9	45	150	18	•
B302200	20	10	45	160	20	•
B302250	25	12.5	50	180	25	•

■ Tolerance

Tolerance	Dia.	μm = 1/1000mm				
		from 1 to 3	over 3 to 6	over 6 to 10	over 10 to 18	over 18 to 30
Cutting Edge(h10)	0	0	0	0	0	
	-40	-48	-58	-70	-84	
Shank(h6)	0	0	0	0	0	
	-6	-8	-9	-11	-13	



2 FLUTE, BALL NOSE EXTRA LONG LENGTH

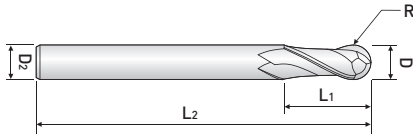

BL422 ...series



EDP. No.	Dia.	R	L ₁	L ₂	D ₂	STOCK
BL422030	3	1.5	30	75	3	•
BL422040	4	2	30	75	4	•
BL422050	5	2.5	40	100	5	•
BL422060	6	3	50	150	6	•
BL422080	8	4	50	150	8	•
BL422100	10	5	60	150	10	•
BL422120	12	6	75	150	12	•
BL422140	14	7	75	150	14	•
BL422160	16	8	75	150	16	•
BL422180	18	9	75	150	18	•
BL422200	20	10	75	150	20	•

■ Tolerance μm = 1/1000mm

Tolerance \ Dia.	from 1 to 3	over 3 to 6	over 6 to 10	over 10 to 18	over 18 to 30
Cutting Edge(h10)	0 -40	0 -48	0 -58	0 -70	0 -84
Shank(h6)	0 -6	0 -8	0 -9	0 -11	0 -13



4 FLUTE, BALL NOSE LONG LENGTH

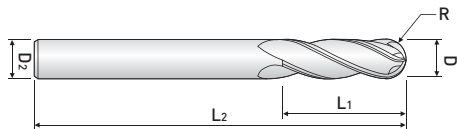

B304 ...series



EDP. No.	Dia.	R	L ₁	L ₂	D ₂	STOCK
B304030	3	1.5	8	70	6	•
B304040	4	2	8	70	6	•
B304050	5	2.5	12	80	6	•
B304060	6	3	12	90	6	•
B304070	7	3.5	20	90	8	•
B304080	8	4	20	100	8	•
B304090	9	4.5	25	100	10	•
B304100	10	5	25	100	10	•
B304110	11	5.5	30	110	12	•
B304120	12	6	30	110	12	•
B304130	13	6.5	35	120	14	•
B304140	14	7	35	120	14	•
B304150	15	7.5	40	140	16	•
B304160	16	8	40	140	16	•
B304180	18	9	45	150	18	•
B304200	20	10	45	160	20	•
B304250	25	12.5	50	180	25	•

■ Tolerance

μm = 1/1000mm

Tolerance	Dia.	from 1 to 3	over 3 to 6	over 6 to 10	over 10 to 18	over 18 to 30
Cutting Edge(h10)		0 -40	0 -48	0 -58	0 -70	0 -84
Shank(h6)		0 -6	0 -8	0 -9	0 -11	0 -13



2 FLUTE, LONG LENGTH

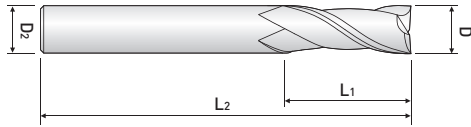

E322 ...series



EDP. No.	Dia.	L ₁	L ₂	D ₂	STOCK
E322030	3	25	75	6	•
E322040	4	25	75	6	•
E322050	5	30	85	6	•
E322060	6	30	85	6	•
E322070	7	35	85	8	•
E322080	8	35	85	8	•
E322090	9	45	100	10	•
E322100	10	45	100	10	•
E322101		60	155		•
E322120	12	55	120	12	•
E322121		65	155		•
E322140	14	60	120	14	•
E322160	16	60	120	16	•
E322161		75	165		•
E322180	18	60	120	18	•
E322200	20	60	120	20	•
E322201		75	165		•

■ Tolerance μm = 1/1000mm

Tolerance \ Dia.	from 1 to 3	over 3 to 6	over 6 to 10	over 10 to 18	over 18 to 30
Cutting Edge(h10)	0 -40	0 -48	0 -58	0 -70	0 -84
Shank(h6)	0 -6	0 -8	0 -9	0 -11	0 -13



4 FLUTE, LONG LENGTH

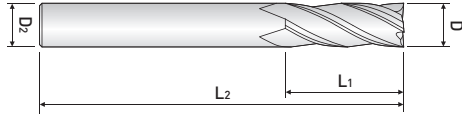

E324 ...series



EDP. No.	D	L ₁	L ₂	D ₂	STOCK
E324030	3	25	75	6	•
E324040	4	25	75	6	•
E324050	5	30	85	6	•
E324060	6	30	85	6	•
E324070	7	35	85	8	•
E324080	8	35	85	8	•
E324090	9	45	100	10	•
E324100	10	45	100	10	•
E324101		60	155		•
E324120	12	55	120	12	•
E324121		65	155		•
E324140	14	60	120	14	•
E324160	16	60	120	16	•
E324161		75	165		•
E324180	18	60	120	18	•
E324200	20	60	120	20	•
E324201		75	165		•

■ Tolerance

Tolerance	Dia.	μm = 1/1000mm				
		from 1 to 3	over 3 to 6	over 6 to 10	over 10 to 18	over 18 to 30
Cutting Edge(h10)	0	0	0	0	0	
	-40	-48	-58	-70	-84	
Shank(h6)	0	0	0	0	0	
	-6	-8	-9	-11	-13	



2 FLUTE, REGULAR LENGTH - BRAZED TYPE

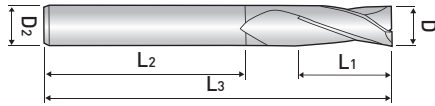

EB302 ...series



EDP. No.	D	L ₁	L ₂	L ₃	D ₂	STOCK
EB302140	14	28	60	98	16	•
EB302150	15	28	60	98	16	•
EB302160	16	28	60	98	16	•
EB302170	17	32	70	115	20	•
EB302180	18	32	70	115	20	•
EB302190	19	32	70	115	20	•
EB302200	20	32	70	115	20	•
EB302210	21	32	70	115	20	•
EB302220	22	32	70	115	20	•
EB302230	23	40	85	140	25	•
EB302240	24	40	85	140	25	•
EB302250	25	40	85	140	25	•
EB302260	26	40	85	140	25	•
EB302270	27	40	85	140	25	•
EB302280	28	40	85	140	25	•
EB302290	29	50	85	150	32	•
EB302300	30	50	85	150	32	•
EB302310	31	50	85	150	32	•
EB302320	32	50	85	150	32	•
EB302350	35	50	85	150	32	•
EB302360	36	50	85	150	32	•
EB302380	38	55	85	155	32	•
EB302400	40	55	85	155	32	•
EB302420	42	55	85	155	32	•
EB302450	45	63	85	160	32	•
EB302500	50	63	85	160	32	•

■ Tolerance

Mill Dia. (mm)	Shank Dia.
0 ~ -0,05	h7

※ Items can be changed for quality improvement without notice.

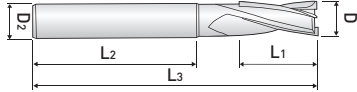

4 FLUTE, REGULAR LENGTH - BRAZED TYPE

EB304 ...series



EDP. No.	D	L ₁	L ₂	L ₃	D ₂	STOCK
EB304140	14	28	60	98	16	•
EB304150	15	28	60	98	16	•
EB304160	16	28	60	98	16	•
EB304170	17	32	70	115	20	•
EB304180	18	32	70	115	20	•
EB304190	19	32	70	115	20	•
EB304200	20	32	70	115	20	•
EB304210	21	32	70	115	20	•
EB304220	22	32	70	115	20	•
EB304230	23	40	85	140	25	•
EB304240	24	40	85	140	25	•
EB304250	25	40	85	140	25	•
EB304260	26	40	85	140	25	•
EB304270	27	40	85	140	25	•
EB304280	28	40	85	140	25	•
EB304290	29	50	85	150	32	•
EB304300	30	50	85	150	32	•
EB304310	31	50	85	150	32	•
EB304320	32	50	85	150	32	•
EB304350	35	50	85	150	32	•
EB304360	36	50	85	150	32	•
EB304380	38	55	85	155	32	•
EB304400	40	55	85	155	32	•
EB304420	42	55	85	155	32	•
EB304450	45	63	85	160	32	•
EB304500	50	63	85	160	32	•

■ Tolerance

Mill Dia. (mm)	Shank Dia.
0 ~ -0,05	h7

※ Items can be changed for quality improvement without notice.



2 FLUTE, LONG LENGTH - BRAZED TYPE

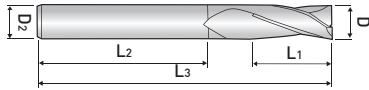

EB322 ...series



EDP. No.	D	L ₁	L ₂	L ₃	D ₂	STOCK
EB322140	14	50	60	130	16	•
EB322150	15	50	60	130	16	•
EB322160	16	50	60	130	16	•
EB322180	18	60	60	140	20	•
EB322200	20	60	60	140	20	•
EB322220	22	60	60	140	20	•
EB322240	24	70	60	150	25	•
EB322250	25	70	60	150	25	•
EB322260	26	70	60	150	25	•
EB322280	28	70	60	150	25	•
EB322300	30	80	70	180	32	•
EB322320	32	90	70	190	32	•
EB322350	35	100	70	200	32	•
EB322380	38	100	70	220	32	•
EB322400	40	100	70	220	32	•
EB322450	45	120	80	230	32	•

■ Tolerance

Mill Dia. (mm)	Shank Dia.
0 ~ -0,05	h7

※ Items can be changed for quality improvement without notice.



4 FLUTE, LONG LENGTH - BRAZED TYPE

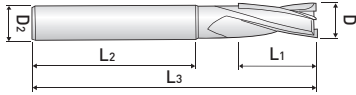

EB324 ...series



EDP. No.	D	L ₁	L ₂	L ₃	D ₂	STOCK
EB324140	14	50	60	130	16	•
EB324150	15	50	60	130	16	•
EB324160	16	50	60	130	16	•
EB324180	18	60	60	140	20	•
EB324200	20	60	60	140	20	•
EB324220	22	60	60	140	20	•
EB324240	24	70	60	150	25	•
EB324250	25	70	60	150	25	•
EB324260	26	70	60	150	25	•
EB324280	28	70	60	150	25	•
EB324300	30	80	70	180	32	•
EB324320	32	90	70	190	32	•
EB324350	35	100	70	200	32	•
EB324380	38	100	70	220	32	•
EB324400	40	100	70	220	32	•
EB324450	45	120	80	230	32	•
EB324500	50	140	80	240	32	•

■ Tolerance

Mill Dia. (mm)	Shank Dia.
0 ~ -0,05	h7

※Items can be changed for quality improvement without notice.

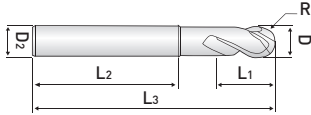

2 FLUTE, BALL NOSE REGULAR LENGTH
- BRAZED TYPE

BB302 ...series



EDP. No.	D	R	L ₁	L ₂	L ₃	D ₂	STOCK
BB302150	15	7.5	28	55	100	16	•
BB302160	16	8	28	55	100	16	•
BB302180	18	9	29	55	110	20	•
BB302200	20	10	29	55	110	20	•
BB302220	22	11	36	60	110	25	•
BB302240	24	12	37	60	110	25	•
BB302250	25	12.5	38	60	120	25	•
BB302280	28	14	40	65	120	32	•
BB302300	30	15	46	65	130	32	•
BB302320	32	16	47	65	140	32	•

■ Tolerance

Mill Dia. (mm)	Shank Dia.
0 ~ -0,05	h7

※ Items can be changed for quality improvement without notice.

□ Nomenclature of End Mill

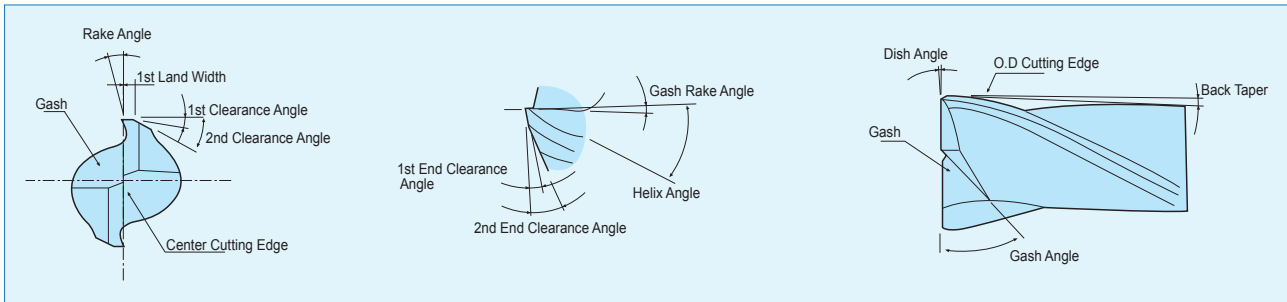

□ Application range of Grade

WORKPIECE	GRADE
Carbon Steel, Alloy Steel, Tool Steel, Metal Mold Steel	* Micro Grain Carbide * P30
Cast Iron, Ductile	* Micro Grain Carbide * K10-K20
Heat Treatment Steel(HRc 40-60)	* Ultrafinest Carbide
Aluminium, Nonferrous Material	* Micro Grain Carbide * K10

□ Formula of End Milling

1) Cutting Speed $V = \frac{\pi \times D \times N}{1000}$ (m/min)	V : Cutting Speed (m/min) D : Diameter of End Mill (mm) N : End Mill revolution (RPM)
2) Feed per tooth $fz = \frac{F}{Z \times N}$ (mm/tooth)	fz : Feed per tooth (mm/tooth) Z : No. of teeth N : End Mill revolution (RPM)
3) Table Feed rate $F = fz \times Z \times N$	F : Feed rate (mm/min) fz : Feed per tooth (mm/tooth) Z : No. of teeth N : End Mill revolution (RPM)
4) Cutting Time $Tc = \frac{L}{F}$	Tc: Cutting Time (min) F : Table feed rate (mm/min) L : Length of cut (workpiece Length+Diameter of Endmill+ α)

▣ For Regrinding

1. Regrinding range

APPLICATION RANGE	CUTTER Dia.	AMOUNT OF FLANK WEAR
Finish Machining	~ $\phi 10$	0.05 ~ 0.1
	$\phi 11 \sim \phi 30$	0.1 ~ 0.25
	$\phi 31 \sim \phi 50$	0.2 ~ 0.35
Rough Machining	~ $\phi 10$	0.08 ~ 0.15
	$\phi 11 \sim \phi 30$	0.15 ~ 0.35
	$\phi 31 \sim \phi 50$	0.3 ~ 0.45

2. Regrinding Method of Relief

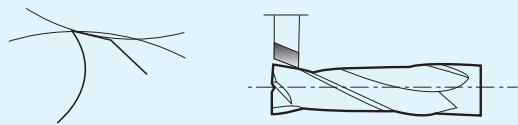
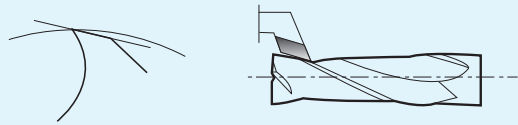
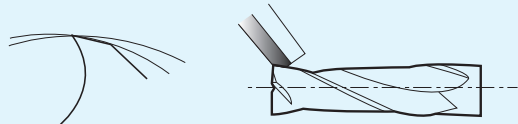
	<p>(1) Concave method</p> <ul style="list-style-type: none"> • In case when precise outer diameter dimension is required. • In case of aluminium machining.
	<p>(2) Flat method</p> <ul style="list-style-type: none"> • Excellent machinability - Applicable to ball end mill and taper end mill. • Secondary clearance angle work is required. - When Diameter is large.
	<p>(3) Eccentric method</p> <ul style="list-style-type: none"> • Excellent toughness and surface roughness. • Secondary clearance angle work is not required.

3. Honing

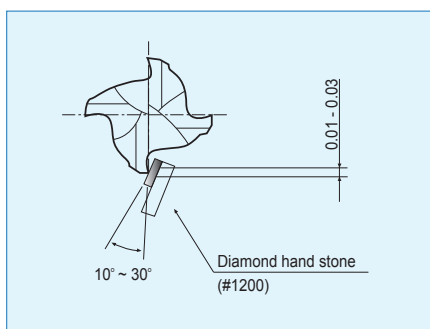

- 1) Recommend honing for machining mold metal and high hardness workpiece.
 - The amount of honing shall be less than that of feed per blade.
- 2) When using end mill without honing, machine for 10 to 30 seconds at feed rate of less than 0.01 mm/blade and then machine at normal feed rate.
- 3) Honing is not required for machining aluminium and non-ferrous metal.

▣ Trouble Shooting for Endmilling

Problems		Cause	Cutting Conditions					Tool shape					Grade		The Others			
			Cutting Speed	Feed Rate	Depth of Cut	Coolant	Up & Down Cut	Relief Angle	Lead Angle	Cutting Length	Numbers of Teeth	Honing	Chip Pocket	Toughness	Hardness	Mechanical Rigidity	Mechanical Chattering	Workpiece Setting
Cutting edge breakage	Excessive wear on periphery	• Improper cutting conditions	▼	▲		⊙								▲				
	Chipping	• Improper cutting conditions • Generation of built-up edge • Improper tool grade		▼			▼	▼			⊙		▲			▼	▲	▼
	Breakage while cutting	• Improper cutting conditions • Excessive cutting load • Excessive overhang		▼	▼				▼			▲			▲		▲	▼
Poor surface finish	• Generation of built-up edge		▲	▲		⊙		▲			⊙							
	• generation of chattering		▼			○	▼		▼					▲	⊙	▲	▼	
	• Surface Squarence			▼	▼		▲		▲	▼							▼	
Oversize or undersize	• Improper cutting conditions • Improper choice of endmill type		▲	▼			▼		▼	▲					▲	▼	▼	
Poor chip control	• Excessive cutting rate • Improper chip Pocket • Improper cutting conditions			▼	▼					▼		▲						

▲ : Increase

▼ : Decrease

○ : Application

⊙ : Proper application

□ ZSTNB series

Work					Carbon Steels, Alloy Steels (180~250HB)	Pre-harden Steels (35~45HRC)	Hardened Steels (45~55HRC)	Hardened Steels (55~65HRC)				
Ratio to standard depth of cut					Depth of Cut X 100%	Depth of Cut X 80%	Depth of Cut X 65%	Depth of Cut X 60%				
R (mm)	Mill Dia (mm)	Neck Length (mm)	Neck Angle (°)	Depth of Cut (mm)	n (min ⁻¹)	Vf (mm/min)	n (min ⁻¹)	Vf (mm/min)	n (min ⁻¹)	Vf (mm/min)	n (min ⁻¹)	Vf (mm/min)
0.1	0.2	1	0.4	0.017	40,000	800	28,000	504	26,000	416	26,000	364
		1.5	0.4	0.009	40,000	800	28,000	504	26,000	416	26,000	364
		2	0.9	0.007	32,000	461	22,400	323	20,800	266	20,800	233
		2.5	0.9	0.004	26,000	333	18,200	204	16,900	189	16,900	162
0.15	0.3	2	0.4	0.025	40,000	1,200	28,000	756	26,000	624	26,000	546
		3	0.9	0.013	32,000	691	22,400	484	20,800	399	20,800	349
		4	0.9	0.010	26,000	499	18,200	306	16,900	284	16,900	243
0.2	0.4	2	0.4	0.035	40,000	1,600	28,000	1,008	26,000	832	26,000	728
		3	0.4	0.020	40,000	1,600	28,000	1,008	26,000	832	26,000	728
		4	0.4	0.007	32,000	922	22,400	645	20,800	532	20,800	466
		4	0.9	0.009	32,000	922	22,400	645	20,800	532	20,800	466
		5	0.4	0.006	26,000	666	18,200	408	16,900	379	16,900	324
		5	0.9	0.007	26,000	666	18,200	408	16,900	379	16,900	324
0.25	0.5	4	0.4	0.040	40,000	2,000	28,000	1,260	26,000	1,040	26,000	910
		8	0.9	0.010	26,000	728	18,200	446	16,900	414	16,900	355
		12	0.9	0.005	22,400	627	15,680	384	14,560	357	14,560	306
0.27	0.54	2	0.4	0.050	40,000	2,160	28,000	1,361	26,000	1,123	26,000	983
		4	0.4	0.037	40,000	2,160	28,000	1,361	26,000	1,123	26,000	983
		5	0.4	0.031	40,000	1,512	28,000	1,176	26,000	1,040	26,000	832
		6	0.4	0.025	26,000	1,244	18,200	871	16,900	676	16,900	629
		6.5	0.4	0.020	26,000	1,011	18,200	619	16,900	575	16,900	493
		7	0.4	0.015	26,000	899	18,200	585	16,900	543	16,900	465
0.3	0.6	2	0.4	0.055	40,000	2,400	28,000	1,512	26,000	1,248	26,000	1,092
		4	0.4	0.035	40,000	2,400	28,000	1,512	26,000	1,248	26,000	1,092
		6	0.4	0.018	32,000	1,382	22,400	968	20,800	799	20,800	699
		6	0.9	0.020	32,000	1,382	22,400	968	20,800	799	20,800	699
		8	0.9	0.020	26,000	998	18,200	612	16,900	568	16,900	487
		10	0.4	0.013	26,000	874	18,200	535	16,900	497	16,900	426
		10	0.9	0.015	26,000	874	18,200	535	16,900	497	16,900	426
		12	0.9	0.010	26,000	874	18,200	535	16,900	497	16,900	426
		15	0.4	0.005	22,400	753	15,680	461	14,560	367	14,560	367
		15	0.9	0.006	22,400	753	15,680	461	14,560	367	14,560	367

▣ ZSTNB series

Work					Carbon Steels, Alloy Steels (180~250HB)	Pre-harden Steels (35~45HRC)	Hardened Steels (45~55HRC)	Hardened Steels (55~65HRC)				
Ratio to standard depth of cut					Depth of Cut X 100%	Depth of Cut X 80%	Depth of Cut X 65%	Depth of Cut X 60%				
R (mm)	Mill Dia (mm)	Neck Length (mm)	Neck Angle (°)	Depth of Cut (mm)	n (min ⁻¹)	Vf (mm/min)	n (min ⁻¹)	Vf (mm/min)	n (min ⁻¹)	Vf (mm/min)	n (min ⁻¹)	Vf (mm/min)
0.4	0.8	4	0.4	0.062	32,000	2,560	22,400	1,613	20,800	1,331	20,800	1,165
		6	0.4	0.045	32,000	2,560	22,400	1,613	20,800	1,331	20,800	1,165
		8	0.9	0.026	25,600	1,475	17,920	1,032	16,640	852	16,640	745
		12	0.9	0.020	20,800	1,065	14,560	699	13,520	606	13,520	519
		16	0.9	0.018	20,800	932	14,560	612	13,520	530	13,520	454
0.45	0.9	4	0.4	0.063	28,300	2,547	19,810	1,605	18,395	1,324	18,395	1,159
		8	0.4	0.050	28,300	2,547	19,810	1,605	18,395	1,324	18,395	1,159
		12	0.4	0.037	18,400	1,325	12,880	811	11,960	753	11,960	646
		16	0.4	0.024	18,400	1,325	12,880	811	11,960	753	11,960	646
		18	0.4	0.018	18,400	1,325	12,880	811	11,960	753	11,960	646
		20	0.4	0.015	15,850	1,141	11,095	699	10,303	649	10,303	556
		22	0.4	0.012	15,850	1,141	11,095	699	10,303	649	10,303	556
		24	0.4	0.009	14,150	1,019	9,905	624	9,198	579	9,198	497
0.5	1	6	0.4	0.055	25,600	2,560	17,920	1,613	16,640	1,331	16,640	1,165
		8	0.4	0.055	25,600	2,560	17,920	1,613	16,640	1,331	16,640	1,165
		10	0.4	0.032	20,800	1,872	14,560	1,310	13,520	1,082	13,520	946
		10	0.9	0.035	20,800	1,872	14,560	1,310	13,520	1,082	13,520	946
		15	0.9	0.028	16,640	1,331	11,648	874	10,816	757	10,816	649
		20	0.4	0.018	16,640	1,331	11,648	874	10,816	757	10,816	649
		20	0.9	0.020	16,640	1,331	11,648	874	10,816	757	10,816	649
		25	0.9	0.017	14,560	1,165	10,192	764	9,464	662	9,464	568
		30	0.4	0.015	12,480	874	8,736	568	8,112	487	8,112	406
		30	0.9	0.017	12,480	874	8,736	568	8,112	487	8,112	406
		35	0.9	0.010	10,400	728	7,280	473	6,760	406	6,760	338
		40	0.9	0.009	10,000	700	7,000	455	6,500	390	6,500	325
		50	0.9	0.007	9,500	665	6,650	432	6,175	371	6,175	309
		60	0.9	0.005	9,000	630	6,300	410	5,850	351	5,850	293
		70	0.9	0.003	8,500	595	5,950	387	5,525	332	5,525	276
0.75	1.5	8	0.4	0.070	16,960	2,544	11,872	1,603	11,024	1,323	11,024	1,158
		10	0.4	0.070	16,960	2,544	11,872	1,603	11,024	1,323	11,024	1,158
		12	0.4	0.070	16,960	2,544	11,872	1,603	11,024	1,323	11,024	1,158
		15	0.9	0.045	13,568	1,832	9,498	1,282	8,819	1,058	8,819	926
		20	0.9	0.040	11,024	1,323	7,717	810	7,166	752	7,166	645
		30	0.9	0.028	11,024	1,323	7,717	810	7,166	752	7,166	645

ZSTNB series

Work					Carbon Steels, Alloy Steels (180~250HB)	Pre-harden Steels (35~45HRC)	Hardened Steels (45~55HRC)	Hardened Steels (55~65HRC)				
Ratio to standard depth of cut					Depth of Cut X 100%	Depth of Cut X 80%	Depth of Cut X 65%	Depth of Cut X 60%				
R (mm)	Mill Dia (mm)	Neck Length (mm)	Neck Angle (°)	Depth of Cut (mm)	n (min ⁻¹)	Vf (mm/min)	n (min ⁻¹)	Vf (mm/min)	n (min ⁻¹)	Vf (mm/min)	n (min ⁻¹)	Vf (mm/min)
0.9	1.8	4	0.4	0.120	14,200	2,556	9,940	1,610	9,230	1,329	9,230	1,163
		8	0.4	0.100	14,200	2,556	9,940	1,610	9,230	1,329	9,230	1,163
		12	0.4	0.080	14,200	2,556	9,940	1,610	9,230	1,329	9,230	1,163
		16	0.4	0.071	14,200	2,556	9,940	1,610	9,230	1,329	9,230	1,163
		20	0.4	0.062	9,230	1,329	6,461	814	6,000	756	6,000	648
		24	0.4	0.053	9,230	1,329	6,461	814	6,000	756	6,000	648
		28	0.4	0.044	9,230	1,329	6,461	814	6,000	756	6,000	648
		32	0.4	0.036	9,230	1,329	6,461	814	6,000	756	6,000	648
		36	0.4	0.028	9,230	1,329	6,461	814	6,000	756	6,000	648
		38	0.4	0.020	8,000	1,152	5,600	706	5,200	655	5,200	562
40	0.4	0.015	8,000	1,152	5,600	706	5,200	655	5,200	562		
1	2	8	0.4	0.150	15,200	3,040	10,640	1,915	9,880	1,581	9,880	1,383
		12	0.4	0.090	15,200	3,040	10,640	1,915	9,880	1,581	9,880	1,383
		16	0.4	0.090	15,200	3,040	10,640	1,915	9,880	1,581	9,880	1,383
		20	0.4	0.060	12,160	2,189	8,512	1,532	7,904	1,265	7,904	1,107
		20	0.9	0.070	12,160	2,189	8,512	1,532	7,904	1,265	7,904	1,107
		25	0.9	0.070	9,880	1,581	6,916	968	6,442	899	6,422	771
		30	0.4	0.040	9,880	1,581	6,916	968	6,442	899	6,422	771
		30	0.9	0.045	9,880	1,581	6,916	968	6,442	899	6,422	771
		35	0.9	0.045	9,880	1,581	6,916	968	6,442	899	6,422	771
		40	0.4	0.030	9,880	1,581	6,916	968	6,442	899	6,422	771
		40	0.9	0.035	9,880	1,581	6,916	968	6,442	899	6,422	771
		50	0.9	0.170	8,512	1,192	5,958	775	5,533	664	5,533	553
		60	0.9	0.009	7,235	1,013	5,065	658	4,703	564	4,703	470
70	0.9	0.005	6,150	861	4,305	560	3,997	480	3,997	400		
1.5	3	8	0.4	0.320	12,720	3,816	8,904	2,404	8,268	1,984	8,268	1,736
		16	0.4	0.220	12,720	3,816	8,904	2,404	8,268	1,984	8,268	1,736
		20	0.4	0.150	12,720	3,434	8,904	2,137	8,268	1,736	8,268	1,488
		30	0.4	0.080	10,176	2,748	7,123	1,496	6,614	1,389	6,614	1,191
		30	0.9	0.090	10,176	2,748	7,123	1,496	6,614	1,389	6,614	1,191
		40	0.4	0.060	8,268	1,984	5,788	1,215	5,374	1,129	5,374	967
		40	0.9	0.070	8,268	1,984	5,788	1,215	5,374	1,129	5,374	967
		50	0.9	0.050	8,268	1,984	5,788	1,215	5,374	1,129	5,374	967
		60	0.9	0.030	7,123	1,710	4,986	1,047	4,630	972	4,630	833
		70	0.9	0.020	6,233	1,496	4,363	916	4,051	851	4,051	729

□ ZSTNB series

Work					Carbon Steels, Alloy Steels (180~250HB)	Pre-harden Steels (35~45HRC)	Hardened Steels (45~55HRC)	Hardened Steels (55~65HRC)				
Ratio to standard depth of cut					Depth of Cut X 100%	Depth of Cut X 80%	Depth of Cut X 65%	Depth of Cut X 60%				
R (mm)	Mill Dia (mm)	Neck Length (mm)	Neck Angle (°)	Depth of Cut (mm)	n (min ⁻¹)	Vf (mm/min)	n (min ⁻¹)	Vf (mm/min)	n (min ⁻¹)	Vf (mm/min)	n (min ⁻¹)	Vf (mm/min)
2	4	20	1	0.32	11,900	2,860	9,000	2,050	7,800	1,680	7,800	1,590
		30	1	0.23	11,900	2,570	9,000	1,850	7,800	1,520	7,800	1,430
		40	1	0.14	9,500	1,940	7,200	1,400	6,200	1,140	6,200	1,080
		50	1	0.11	7,800	1,590	5,800	1,120	5,000	920	5,000	870
		60	1	0.07	7,800	1,590	5,800	1,120	5,000	920	5,000	870
2.5	5	30	1	0.34	9,500	2,140	7,200	1,540	6,200	1,260	6,200	1,190
		40	1	0.25	9,500	2,140	7,200	1,540	6,200	1,260	6,200	1,190
		60	1	0.15	6,200	1,320	4,700	950	4,000	770	4,000	720
3	6	30	1	0.45	8,000	2,000	6,000	1,430	5,200	1,170	5,200	1,110
		40	1	0.40	8,000	1,800	6,000	1,280	5,200	1,050	5,200	990
		50	1	0.32	8,000	1,800	6,000	1,280	5,200	1,050	5,200	990
		60	1	0.22	6,400	1,360	4,800	970	4,100	780	4,100	740
		70	1	0.18	5,200	1,110	3,900	790	3,400	650	3,400	610
		80	1	0.14	5,200	1,110	3,900	790	3,400	650	3,400	610
4	8	50	1	0.50	6,000	1,460	4,500	1,040	3,900	850	3,900	810
		60	1	0.43	6,000	1,460	4,500	1,040	3,900	850	3,900	810
		70	1	0.33	6,000	1,460	4,500	1,040	3,900	850	3,900	810
		80	1	0.25	4,800	1,100	3,600	780	3,100	640	3,100	600
5	10	60	1	0.70	4,800	1,300	3,600	920	3,100	750	3,100	710
		75	1	0.50	4,800	1,300	3,600	920	3,100	750	3,100	710

- Please adjust the cutting depth index according to the cutting depth factors of above table.
- For Rib or Slotting machining process which are not easy for chip ejection, please reduce the cutting depth by 20~30% from the above cutting condition.
 - ex) ZSTNB2040-20-10, HRC 55, Rib processing
Cutting depth : 0.32(standard cutting depth) X 0.65 X 0.8 = 0.17mm
- In actual machining, the condition should be adjusted according to the machining shape, purpose and the machine type.
- If RPM of the machine is low, the feed rate should be low in the same ratio as RPM.

□ ZSTNR series

Work				Carbon Steels, Alloy Steels (180~250HB)		Pre-harden Steels (35~45HRC)		Hardened Steels (45~55HRC)		Hardened Steels (55~65HRC)	
Ratio to standard depth of cut				Depth of Cut X 100%		Depth of Cut X 80%		Depth of Cut X 65%		Depth of Cut X 60%	
Mill Dia (mm)	R (mm)	Neck Length (mm)	Depth of Cut (mm)	n (min ⁻¹)	Vf (mm/min)	n (min ⁻¹)	Vf (mm/min)	n (min ⁻¹)	Vf (mm/min)	n (min ⁻¹)	Vf (mm/min)
0.2	0.05	2	0.007	39,660	887	33,660	754	29,700	591	27,720	483
0.4	0.05	4	0.009	30,096	899	25,582	764	22,572	599	21,067	489
		5	0.007	26,752	710	22,739	528	20,064	466	18,726	373
	0.1	4	0.009	31,680	946	26,928	804	23,760	631	22,176	515
		5	0.007	28,160	747	23,936	556	21,120	490	19,712	392
0.5	0.1	5	0.013	30,413	1,090	25,851	753	22,810	562	21,289	453
		8	0.008	24,330	678	20,681	468	18,248	350	17,031	282
		10	0.007	18,248	509	15,511	351	13,686	262	12,773	211
0.6	0.1	12	0.010	20,377	791	17,320	546	15,282	408	14,264	329
		15	0.006	16,727	649	14,218	448	12,545	335	11,709	270
0.8	0.2	6	0.045	31,680	1,084	26,928	921	23,760	723	22,176	590
		12	0.020	28,160	943	23,936	695	21,120	613	19,712	490
1	0.2	8	0.040	28,512	1,463	24,235	1,244	21,384	976	19,958	797
		10	0.035	28,512	1,596	24,235	1,357	21,384	1,064	19,958	869
		15	0.028	25,344	1,261	21,542	938	19,008	828	17,741	662
		20	0.020	19,008	828	16,157	653	14,256	532	13,306	414
		25	0.017	15,840	690	13,464	544	11,880	443	11,088	345
		30	0.017	15,840	690	13,464	544	11,880	443	11,088	345
	0.3	8	0.040	28,512	1,463	24,235	1,244	21,384	976	19,958	797
		15	0.028	25,344	1,261	21,542	938	19,008	828	17,741	662
		25	0.017	15,840	690	13,464	544	11,880	443	11,088	345
		30	0.017	15,840	690	13,464	544	11,880	443	11,088	345
1.5	0.2	10	0.050	21,683	1,079	18,431	803	16,262	708	15,178	567
		15	0.045	19,712	981	16,755	730	14,784	644	13,798	515
		20	0.042	17,347	863	14,745	642	13,010	567	12,143	453
		25	0.032	14,784	644	12,566	508	11,088	414	10,349	322
	0.3	30	0.028	12,320	536	10,472	423	9,240	345	8,624	268
		10	0.050	21,683	1,079	18,431	803	16,262	708	15,178	567
		20	0.042	17,347	863	14,745	642	13,010	567	12,143	453
		25	0.032	14,784	644	12,566	508	11,088	414	10,349	322
30	0.028	12,320	536	10,472	423	9,240	345	8,624	268		

▣ ZSTNR series

Work				Carbon Steels, Alloy Steels (180~250HB)		Pre-harden Steels (35~45HRC)		Hardened Steels (45~55HRC)		Hardened Steels (55~65HRC)		
Ratio to standard depth of cut				Depth of Cut X 100%		Depth of Cut X 80%		Depth of Cut X 65%		Depth of Cut X 60%		
Mill Dia (mm)	R (mm)	Neck Length (mm)	Depth of Cut (mm)	n (min ⁻¹)	Vf (mm/min)	n (min ⁻¹)	Vf (mm/min)	n (min ⁻¹)	Vf (mm/min)	n (min ⁻¹)	Vf (mm/min)	
2	0.2	30	0.045	13,440	1,254	11,424	933	10,080	823	9,408	658	
		40	0.035	10,080	823	8,568	650	7,560	529	7,056	412	
		50	0.017	8,400	686	7,140	541	6,300	441	5,880	343	
	0.3	12	0.088	22,680	1,814	19,278	1,427	17,010	1,191	15,876	1,048	
		20	0.054	18,144	1,452	15,422	1,141	13,608	953	12,701	838	
		30	0.045	13,440	1,393	11,424	1,036	10,080	914	9,408	732	
		40	0.035	10,080	914	8,568	722	7,560	588	7,056	457	
	0.5	50	0.017	8,400	762	7,140	601	6,300	490	5,880	381	
		8	0.170	22,680	1,814	19,278	1,427	17,010	1,191	15,876	1,048	
		12	0.088	22,680	1,814	19,278	1,427	17,010	1,191	15,876	1,048	
		16	0.088	19,278	1,542	16,386	1,213	14,459	1,012	13,495	891	
		20	0.054	18,114	1,452	15,422	1,141	13,608	953	12,701	838	
		25	0.054	15,876	1,270	13,495	999	11,907	833	11,113	733	
		30	0.045	13,440	1,393	11,424	1,036	10,080	914	9,408	732	
	3	0.2	40	0.070	10,240	956	8,704	711	7,680	627	7,168	502
			50	0.050	7,680	627	6,528	495	5,760	403	5,376	314
			60	0.030	6,400	523	5,440	412	4,800	336	4,480	261
		0.3	40	0.070	10,240	1,062	8,704	790	7,680	697	7,168	557
50			0.050	7,680	697	6,528	550	5,760	448	5,376	348	
60			0.030	6,400	581	5,440	458	4,800	373	4,480	290	
0.5		40	0.070	10,240	1,062	8,704	790	7,680	697	7,168	557	
		50	0.050	7,680	697	6,528	550	5,760	448	5,376	348	
		60	0.030	6,400	581	5,440	458	4,800	373	4,480	290	

- Please adjust the cutting depth index according to the cutting depth factors of above table.
- In actual machining, the condition should be adjusted according to the machining shape, purpose and machine type.
- If RPM of the machine is low, the feed rate should be low in the same ratio as RPM.

□ ZSLNR series

Work				Carbon Steels, Alloy Steels (180~250HB)		Pre-hardened Steels (35~45HRC)		Hardened Steels (45~55HRC)		Hardened Steels (55~65HRC)		
Ratio to standard depth of cut				Depth of Cut X 100%		Depth of Cut X 80%		Depth of Cut X 65%		Depth of Cut X 60%		
Mill Dia (mm)	R (mm)	Neck Length (mm)	Depth of Cut (mm)	n (min ⁻¹)	Vf (mm/min)	n (min ⁻¹)	Vf (mm/min)	n (min ⁻¹)	Vf (mm/min)	n (min ⁻¹)	Vf (mm/min)	
0.2	0.05	0.5	0.020	50,000	258	50,000	205	50,000	180	50,000	160	
		1	0.014	50,000	258	50,000	205	50,000	180	50,000	160	
		1.5	0.008	50,000	240	45,900	202	45,900	170	45,900	153	
		2	0.008	42,000	202	36,700	176	36,700	162	36,700	147	
0.3	0.05	1	0.021	50,000	585	50,000	456	50,000	336	50,000	320	
		1.5	0.016	50,000	585	45,000	456	45,000	336	45,000	320	
		2	0.012	45,000	530	45,000	420	45,000	300	45,000	290	
		2.5	0.010	40,000	471	40,000	373	40,000	267	40,000	258	
		3	0.008	35,000	412	35,000	326	30,000	200	30,000	194	
0.4	0.05	1	0.025	50,000	580	50,000	461	40,000	320	36,000	270	
		1.5	0.020	50,000	580	50,000	461	40,000	320	36,000	270	
		2	0.016	45,000	520	45,000	410	36,000	290	34,000	240	
		2.5	0.015	40,500	480	40,500	370	33,400	270	30,600	220	
		3	0.014	40,000	410	40,000	330	32,800	240	25,600	200	
		3.5	0.012	36,000	380	36,000	300	29,400	200	22,920	180	
	0.1	0.1	4	0.008	30,000	320	30,000	250	21,600	160	19,200	150
			2	0.028	45,000	520	45,000	410	36,000	290	34,000	240
			3	0.016	40,000	410	40,000	330	32,800	240	25,600	200
			4	0.010	30,000	320	30,000	250	21,600	160	19,200	150
0.5	0.05	1	0.030	50,000	898	40,000	464	30,000	378	28,000	315	
		2	0.023	50,000	898	40,000	464	30,000	378	28,000	315	
		3	0.017	45,000	810	36,000	414	27,000	315	24,500	261	
		4	0.017	40,000	820	32,000	378	24,000	279	20,000	234	
		5	0.011	28,800	540	19,400	280	18,000	250	15,000	200	
		6	0.008	28,800	480	19,400	260	18,000	250	15,000	200	
	0.1	0.1	1	0.035	50,000	898	40,000	464	30,000	378	28,000	315
			2	0.030	50,000	898	40,000	464	30,000	378	28,000	315
			3	0.020	45,000	810	36,000	414	27,000	315	24,500	261
			4	0.020	40,000	720	32,000	378	24,000	279	20,000	234
			5	0.013	28,800	540	19,400	280	18,000	250	15,000	200
			6	0.013	28,800	480	19,400	260	18,000	250	15,000	200
0.6	0.1	2	0.035	50,000	1,159	37,830	600	28,200	390	23,000	320	
		4	0.024	40,000	830	27,800	440	23,600	280	21,000	230	
		6	0.015	24,000	490	18,000	300	17,800	240	15,000	210	
		8	0.013	24,000	466	18,000	285	17,800	228	15,000	200	
		10	0.009	24,000	451	18,000	276	17,800	221	15,000	193	

□ ZSTNR series

Work				Carbon Steels, Alloy Steels (180~250HB)		Pre-harden Steels (35~45HRC)		Hardened Steels (45~55HRC)		Hardened Steels (55~65HRC)		
Ratio to standard depth of cut				Depth of Cut X 100%		Depth of Cut X 80%		Depth of Cut X 65%		Depth of Cut X 60%		
Mill Dia (mm)	R (mm)	Neck Length (mm)	Depth of Cut (mm)	n (min ⁻¹)	Vf (mm/min)	n (min ⁻¹)	Vf (mm/min)	n (min ⁻¹)	Vf (mm/min)	n (min ⁻¹)	Vf (mm/min)	
0.8	0.1	4	0.032	48,000	1,102	28,000	518	20,000	320	20,000	288	
		6	0.019	38,700	800	25,000	461	18,000	288	18,000	256	
		8	0.015	29,025	600	20,000	369	16,200	259	16,200	230	
		12	0.012	29,025	570	20,000	350	16,200	246	16,200	219	
	0.2	4	0.056	48,000	1,102	28,000	518	20,000	320	20,000	288	
		6	0.032	38,700	800	25,000	461	18,000	288	18,000	256	
1	0.1	4	0.038	32,400	1,359	27,540	1,039	24,300	815	22,680	666	
		6	0.024	26,244	990	22,307	842	19,683	660	18,371	539	
		8	0.024	23,328	880	19,829	748	17,496	587	16,330	479	
		10	0.015	20,412	770	17,350	655	15,309	514	14,288	419	
		12	0.015	18,144	609	15,422	453	13,608	399	12,701	320	
		16	0.009	18,144	533	15,422	420	13,608	342	12,701	266	
		20	0.006	13,608	399	11,567	315	10,206	257	9,526	200	
	0.2	4	0.070	32,400	1,359	27,540	1,039	24,300	815	22,680	666	
		6	0.040	26,244	990	22,307	842	19,683	660	18,371	539	
		8	0.040	23,328	880	19,829	748	17,496	587	16,330	479	
		10	0.025	20,412	770	17,350	655	15,309	514	14,288	419	
		12	0.025	18,144	609	15,422	453	13,608	399	12,701	320	
		16	0.015	18,144	533	15,422	420	13,608	342	12,701	266	
		20	0.010	13,608	399	11,567	315	10,206	257	9,526	200	
	0.3	6	0.040	26,244	990	22,307	842	19,683	660	18,371	539	
		10	0.025	20,412	770	17,350	655	15,309	514	14,288	419	
		16	0.015	18,144	533	15,422	420	13,608	342	12,701	266	
		20	0.010	13,608	399	11,567	315	10,206	257	9,526	200	
	1.5	0.1	4	0.042	24,930	1,130	20,956	868	18,711	678	17,364	556
			8	0.036	22,680	1,027	19,278	873	17,010	685	15,876	559
			12	0.036	18,144	822	15,422	698	13,608	548	12,701	447
			15	0.023	14,112	568	11,995	423	10,584	373	9,878	298
			20	0.018	14,112	568	11,995	423	10,584	373	9,878	298
		0.2	4	0.070	24,930	1,130	20,956	868	18,711	678	17,364	556
8			0.060	22,680	1,027	19,278	873	17,010	685	15,876	559	
12			0.060	18,144	822	15,422	698	13,608	548	12,701	447	
15			0.038	14,112	568	11,995	423	10,584	373	9,878	298	
20			0.030	14,112	568	11,995	423	10,584	373	9,878	298	
0.3		8	0.060	22,680	1,027	19,278	873	17,010	685	15,876	559	
		15	0.038	14,112	568	11,995	423	10,584	373	9,878	298	
		20	0.030	14,112	568	11,995	423	10,584	373	9,878	298	

□ ZSTNR series

Work				Carbon Steels, Alloy Steels (180~250HB)		Pre-harden Steels (35~45HRC)		Hardened Steels (45~55HRC)		Hardened Steels (55~65HRC)	
Ratio to standard depth of cut				Depth of Cut X 100%		Depth of Cut X 80%		Depth of Cut X 65%		Depth of Cut X 60%	
Mill Dia (mm)	R (mm)	Neck Length (mm)	Depth of Cut (mm)	n (min ⁻¹)	Vf (mm/min)	n (min ⁻¹)	Vf (mm/min)	n (min ⁻¹)	Vf (mm/min)	n (min ⁻¹)	Vf (mm/min)
2	0.2	6	0.080	20,790	1,635	17,672	1,389	15,593	981	14,553	801
		8	0.070	18,900	1,486	16,065	1,263	14,175	892	13,230	728
		12	0.040	15,309	1,083	13,013	921	11,482	722	10,716	590
		16	0.040	13,608	963	11,567	818	10,206	642	9,526	524
		20	0.035	11,907	843	10,121	716	8,930	562	8,335	459
		25	0.025	11,907	843	10,121	716	8,930	562	8,335	459
		30	0.017	11,312	800	9,615	680	8,484	534	7,918	436
	0.3	8	0.090	18,900	1,651	16,065	1,403	14,175	991	13,230	809
		16	0.060	13,608	1,070	11,567	909	10,206	713	9,526	583
		20	0.037	11,907	936	10,121	796	8,930	624	8,335	510
	0.5	6	0.017	20,709	1,635	17,672	1,389	15,593	981	14,553	801
		8	0.014	18,900	1,651	16,065	1,403	14,175	991	13,230	809
		12	0.080	15,309	1,204	13,013	1,023	11,482	802	10,716	655
		16	0.080	13,608	1,070	11,567	909	10,206	713	9,526	583
		20	0.050	11,907	936	10,121	796	8,930	624	8,335	510
		25	0.050	11,907	936	10,121	796	8,930	624	8,335	510
		30	0.030	11,312	889	9,615	756	8,484	593	7,918	484
	0.8	8	0.200	18,900	1,651	16,065	1,403	14,175	991	13,230	809
		16	0.100	13,608	1,070	11,567	909	10,206	713	9,526	583
		20	0.060	11,907	936	10,121	796	8,930	624	8,335	510
	3	0.2	8	0.090	14,400	1,415	12,240	1,203	10,800	849	10,080
12			0.070	14,400	1,415	12,240	1,203	10,800	849	10,080	693
16			0.050	14,400	1,415	12,240	1,203	10,800	849	10,080	693
20			0.050	11,664	1,146	9,914	974	8,748	764	8,165	624
30			0.040	9,072	1,146	7,711	974	6,804	764	6,350	624
35			0.035	9,072	1,146	7,711	974	6,804	764	6,350	624
0.3		8	0.130	14,400	1,572	12,240	1,337	10,800	943	10,080	771
		16	0.075	14,400	1,572	12,240	1,337	10,800	943	10,080	771
		20	0.075	11,664	1,274	9,914	1,083	8,748	849	8,165	693
		30	0.060	9,072	1,274	7,711	1,083	6,804	849	6,350	693
0.5		8	0.180	14,400	1,572	12,240	1,337	10,800	943	10,080	771
		12	0.130	14,400	1,572	12,240	1,337	10,800	943	10,080	771
		16	0.100	14,400	1,572	12,240	1,337	10,800	943	10,080	771
		20	0.100	11,664	1,274	9,914	1,083	8,748	849	8,165	693
		30	0.080	9,072	1,274	7,711	1,083	6,804	849	6,350	693
	35	0.065	9,072	1,274	7,711	1,083	6,804	849	6,350	693	

- Please adjust the cutting depth index according to the cutting depth factors of above table.
- In actual machining, the condition should be adjusted according to the machining shape, purpose and machine type.
- If RPM of the machine is low, the feed rate should be low in the same ratio as RPM.

▣ ZS1(2)04, ZS204 series ▶ Side Cutting

MATERIAL	HARDENED STEELS		HARDENED STEELS		HARDENED STEELS		HARDENED STEELS		HARDENED STEELS	
HARDNESS	HRc 40~HRc 50		HRc 50~HRc 55		HRc 55~HRc 60		HRc 60~HRc 65		HRc 65~HRc 70	
DIAMETER(mm)	RPM	FEED	RPM	FEED	RPM	FEED	RPM	FEED	RPM	FEED
4	17200	1690	11440	1140	9360	700	7280	430	6170	310
6	13450	1820	8970	1230	6890	720	5460	450	4810	330
8	9100	1750	6760	1170	5200	670	4160	420	3640	310
10	8000	1630	5330	1090	4160	620	3320	400	2860	280
12	6830	1630	4550	1010	3450	580	2730	370	2420	260

RPM = rev. / min.
FEED = mm / min.

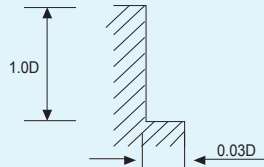

▣ ZSPM4...-.. series

MATERIAL	HARDENED STEELS									
HARDNESS	~HRc40		HRc 40 ~ HRc 50		HRc 50 ~ HRc 55		HRc 55 ~ HRc 60		HRc 60 ~ HRc 65	
D X R(mm)	RPM	FEED	RPM	FEED	RPM	FEED	RPM	FEED	RPM	FEED
3 X R0.5	9550	6500	6900	4150	4550	2750	2850	1150	1900	610
4 X R0.5	7950	7000	5750	4600	4000	3200	2550	1350	1750	700
6 X R0.5	5800	7650	4100	4900	2900	3500	1850	1850	1350	795
6 X R1.0	5800	7650	4100	4900	2900	3500	1850	1850	1350	795
8 X R1.0	4350	7650	3050	4900	2200	3500	1400	1850	995	795
8 X R2.0	4350	7650	3050	4900	2200	3500	1400	1850	995	795
10 X R1.0	3500	7650	2450	4900	1750	3500	1100	1850	795	795
10 X R2.0	3500	7650	2450	4900	1750	3500	1100	1850	795	795
12 X R2.0	2900	7650	2050	4900	1450	3500	925	1850	665	795
12 X R3.0	2900	7650	2050	4900	1450	3500	925	1850	665	795

RPM = rev. / min.
FEED = mm / min.

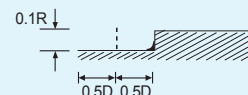
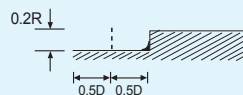

ZSPM4...-.. series ▶ High Speed Cutting

MATERIAL HARDNESS	HARDENED STEELS									
	~HRc40		HRc 40 ~ HRc 50		HRc 50 ~ HRc 55		HRc 55 ~ HRc 60		HRc 60 ~ HRc 65	
D X R(mm)	RPM	FEED	RPM	FEED	RPM	FEED	RPM	FEED	RPM	FEED
3 X R0.5	22000	16000	17000	10000	12500	8000	9500	4600	6900	2500
4 X R0.5	17000	17500	13000	12000	11000	9200	8000	5500	5600	2900
6 X R0.5	13500	18500	10500	13800	9000	11000	6400	6400	4500	3600
6 X R1.0	13500	18500	10500	13800	9000	11000	6400	6400	4500	3600
8 X R1.0	10000	18500	8000	14000	6800	11000	4800	6700	3400	4100
8 X R2.0	10000	18500	8000	14000	6800	11000	4800	6700	3400	4100
10 X R1.0	8000	18500	6400	14000	5400	11000	3800	6800	2700	3800
10 X R2.0	8000	18500	6400	14000	5400	11000	3800	6800	2700	3800
12 X R2.0	6600	18500	5300	14000	4500	11000	3200	7000	2250	3600
12 X R3.0	6600	18500	5300	14000	4500	11000	3200	7000	2250	3600

RPM = rev. / min.
FEED = mm / min.

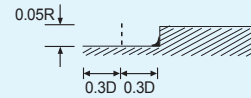
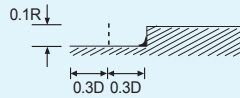

DB702, DB712 series

MATERIAL HARDNESS	HARDENED STEELS HEAT RESISTANT STEELS	HARDENED STEELS		HARDENED STEELS		HARDENED STEELS		HARDENED STEELS		HARDENED STEELS		
	HRc 30~ HRc 40	HRc 40~ HRc 50	HRc 50~ HRc 55	HRc 55~ HRc 60	HRc 60~ HRc 65	HRc 65~ HRc 70						
DIAMETER(mm)	RPM	FEED	RPM	FEED	RPM	FEED	RPM	FEED	RPM	FEED	RPM	FEED
0.2	50000	1200	50000	1050	45000	960	40000	770	35000	674	31500	570
0.3	50000	1500	50000	1350	45000	1200	40000	965	35000	840	31500	700
0.4	50000	1900	50000	1700	45000	1500	40000	1200	35000	1050	31500	890
0.5	50000	2400	50000	2100	45000	1900	40000	1500	35000	1300	31500	1100
0.6	50000	2900	50000	2500	45000	2200	40000	1800	35000	1600	31500	1400
0.8	50000	3900	50000	3300	45000	3000	40000	2400	35000	2100	31500	1800
1	50000	4800	50000	4200	45000	3800	40000	3000	35000	2600	35000	2300
1.5	50000	5400	48000	4500	43000	4000	37000	3100	33000	2700	29700	2300
2	49700	5700	47800	4800	40000	4000	35000	3150	32000	2800	28500	2300
3	33100	6000	31800	5300	26500	4000	23500	3150	21000	2800	19000	2300
4	24900	6000	23900	5300	20000	4000	17500	3150	16000	2800	14500	2300
5	18600	5800	17800	4900	15000	3750	13500	3050	11500	2550	10500	2100
6	13900	4850	13400	4100	11000	3100	10000	2500	8800	2150	8000	1750
8	11100	4200	10700	3500	9000	2700	8000	2150	7000	1850	6500	1550
10	9300	3700	8900	3100	7500	2400	6600	1900	5800	1650	5300	1380
12	6950	2950	6680	2500	5600	1900	5000	1550	4400	1250	4000	1050

RPM = rev. / min.
FEED = mm / min.

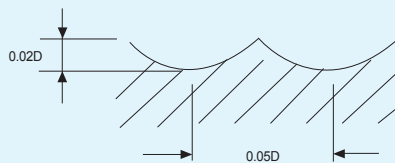

ZE702, ZE712 series ▶ Slotting

MATERIAL	HARDENED STEELS HEAT RESISTANT STEELS		HARDENED STEELS		HARDENED STEELS		HARDENED STEELS		HARDENED STEELS		HARDENED STEELS	
	HARDNESS	HRc 30~ HRc 40	HRc 40~ HRc 50	HRc 50~ HRc 55	HRc 55~ HRc 60	HRc 60~ HRc 65	HRc 65~ HRc 70	RPM	FEED	RPM	FEED	RPM
DIAMETER(mm)	RPM	FEED	RPM	FEED	RPM	FEED	RPM	FEED	RPM	FEED	RPM	FEED
0.2	50000	130	45000	115	40000	95	33000	60	33000	45	26400	30
0.3	50000	190	45000	140	40000	115	33000	70	25000	50	20000	35
0.4	50000	235	45000	180	40000	140	33000	90	25000	55	20000	40
0.5	50000	370	45000	280	40000	220	33000	140	25000	85	20000	60
0.6	50000	470	45000	360	40000	285	30000	160	25000	105	20000	75
0.8	50000	600	40000	440	30000	295	25000	185	19000	110	15200	80
0.9	49000	655	39000	520	27800	330	22700	205	17500	125	14000	90
1	48000	750	38000	570	25500	360	20500	215	16000	135	12500	85
2	33300	850	26000	680	17500	420	14500	260	11000	160	9500	115
3	21800	850	17300	680	11500	420	9500	260	7500	160	6400	115
4	16700	880	13200	700	8800	440	7200	270	5600	170	4750	118
5	15700	1000	12500	805	8300	500	6400	285	5100	180	4450	132
6	13100	950	10350	770	6900	480	5300	280	4200	180	3700	130
8	9880	930	7800	720	5200	445	4000	255	3200	165	2800	120
10	7800	850	6150	680	4100	415	3200	240	2550	155	2200	112
12	6650	850	5250	680	3500	415	2650	240	2100	155	1860	112
16	4900	730	3900	580	2600	365	2000	210	1600	135	1400	95
20	3900	660	3100	525	2050	335	1600	195	1300	125	1100	85

RPM = rev. / min.
FEED = mm / min.

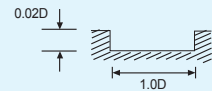
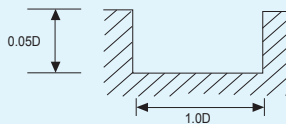

ZE702, ZE712 series ▶ Side Cutting

MATERIAL	HARDENED STEELS HEAT RESISTANT STEELS		HARDENED STEELS		HARDENED STEELS		HARDENED STEELS		HARDENED STEELS		HARDENED STEELS	
	HARDNESS	HRc 30~ HRc 40	HRc 40~ HRc 50	HRc 50~ HRc 55	HRc 55~ HRc 60	HRc 60~ HRc 65	HRc 65~ HRc 70	RPM	FEED	RPM	FEED	RPM
DIAMETER(mm)	RPM	FEED	RPM	FEED	RPM	FEED	RPM	FEED	RPM	FEED	RPM	FEED
1	48000	1050	38000	820	25500	510	20500	310	16000	190	12500	125
2	33300	1200	26000	970	17500	600	14500	370	11000	230	9500	165
3	21800	1200	17300	970	11500	600	9500	370	7500	230	6400	165
4	16700	1250	13200	1000	8800	625	7200	385	5600	240	4750	170
5	15700	1450	12500	1150	8300	710	6400	410	5100	260	4450	190
6	13100	1350	10350	1100	6900	690	5300	400	4200	255	3700	185
8	9880	1320	7800	1030	5200	635	4000	365	3200	235	2800	170
10	7800	1200	6150	970	4100	590	3200	340	2550	220	2200	160
12	6650	1200	5250	970	3500	590	2650	340	2100	220	1860	160
16	4900	1050	3900	840	2600	520	2000	300	1600	190	1400	140
20	3900	950	3100	750	2050	475	1600	275	1300	175	1100	125

RPM = rev. / min.
FEED = mm / min.

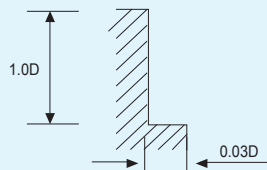

ZE704, ZE714, ZE724 series ▶ Side Cutting

MATERIAL	HARDENED STEELS HEAT RESISTANT STEELS		HARDENED STEELS		HARDENED STEELS		HARDENED STEELS		HARDENED STEELS		HARDENED STEELS	
	HARDNESS	HRc 30~ HRc 40	HRc 40~ HRc 50	HRc 50~ HRc 55	HRc 55~ HRc 60	HRc 60~ HRc 65	HRc 65~ HRc 70	RPM	FEED	RPM	FEED	RPM
DIAMETER(mm)	RPM	FEED	RPM	FEED	RPM	FEED	RPM	FEED	RPM	FEED	RPM	FEED
1	48000	1480	38000	1050	25500	710	20500	430	16000	270	12500	175
2	33300	1750	26000	1250	17500	840	14500	520	11000	320	9500	230
3	21800	1750	17300	1250	11500	840	9500	520	7500	320	6400	230
4	16700	1800	13200	1300	8800	880	7200	540	5600	335	4750	240
5	15700	2000	12500	1500	8300	1000	6400	580	5100	370	4450	270
6	13100	1950	10350	1400	6900	950	5300	560	4200	350	3700	260
8	9880	1880	7800	1350	5200	900	4000	520	3200	330	2800	240
10	7800	1750	6150	1260	4100	840	3200	480	2550	310	2200	220
12	6650	1750	5250	1260	3500	840	2650	480	2100	300	1860	220
16	4900	1500	3900	1100	2600	730	2000	420	1600	270	1400	200
20	3900	1300	3100	970	2050	650	1600	380	1300	250	1100	180

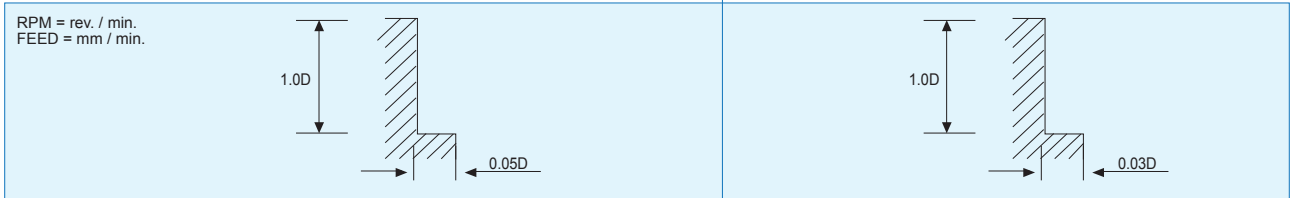

ZR702, ZR732 series ▶ Slotting

MATERIAL	HARDENED STEELS HEAT RESISTANT STEELS		HARDENED STEELS		HARDENED STEELS		HARDENED STEELS		HARDENED STEELS		HARDENED STEELS	
	HARDNESS	HRc 30~ HRc 40	HRc 40~ HRc 50	HRc 50~ HRc 55	HRc 55~ HRc 60	HRc 60~ HRc 65	HRc 65~ HRc 70	RPM	FEED	RPM	FEED	RPM
DIAMETER(mm)	RPM	FEED	RPM	FEED	RPM	FEED	RPM	FEED	RPM	FEED	RPM	FEED
2	33300	680	26000	544	17500	336	14500	208	11000	128	9500	92
3	21800	680	17300	544	11500	336	9500	208	7500	128	6400	92
4	16700	704	13200	560	8800	352	7200	216	5600	136	4750	94
5	15700	800	12500	644	8300	400	6400	228	5100	144	4450	106
6	13100	760	10350	616	6900	384	5300	224	4200	144	3700	104
8	9880	744	7800	576	5200	356	4000	204	3200	132	2800	96
10	7800	680	6150	544	4100	332	3200	192	2550	124	2200	90
12	6650	680	5250	544	3500	332	2650	192	2100	124	1860	90
16	4900	584	3900	464	2600	292	2000	168	1600	108	1400	78
20	3900	528	3100	420	2050	268	1600	168	1300	100	1100	70

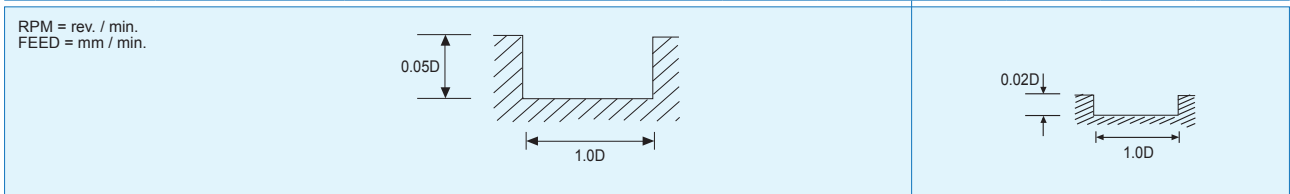

▣ ZR702, ZR732 series ▶ Side Cutting

MATERIAL	HARDENED STEELS HEAT RESISTANT STEELS		HARDENED STEELS		HARDENED STEELS		HARDENED STEELS		HARDENED STEELS		HARDENED STEELS	
	HARDNESS	HRc 30~ HRc 40	HRc 40~ HRc 50	HRc 50~ HRc 55	HRc 55~ HRc 60	HRc 60~ HRc 65	HRc 65~ HRc 70					
DIAMETER(mm)	RPM	FEED	RPM	FEED	RPM	FEED	RPM	FEED	RPM	FEED	RPM	FEED
2	33300	960	26000	776	17500	480	14500	296	11000	184	9500	132
3	21800	960	17300	776	11500	480	9500	296	7500	184	6400	132
4	16700	1000	13200	800	8800	500	7200	308	5600	192	4750	136
5	15700	1160	12500	920	8300	568	6400	328	5100	208	4450	152
6	13100	1080	10350	880	6900	552	5300	320	4200	204	3700	148
8	9880	1056	7800	824	5200	508	4000	292	3200	188	2800	136
10	7800	960	6150	776	4100	472	3200	272	2550	176	2200	128
12	6650	960	5250	776	3500	472	2650	272	2100	176	1860	128
16	4900	840	3900	672	2600	416	2000	240	1600	152	1400	112
20	3900	760	3100	600	2050	380	1600	220	1300	140	1100	100

RPM = rev. / min.
FEED = mm / min.

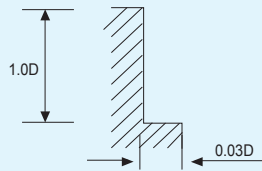

▣ ZR704, ZR714, ZR724, ZR734 series

MATERIAL	HARDENED STEELS HEAT RESISTANT STEELS		HARDENED STEELS		HARDENED STEELS		HARDENED STEELS		HARDENED STEELS		HARDENED STEELS	
	HARDNESS	HRc 30~ HRc 40	HRc 40~ HRc 50	HRc 50~ HRc 55	HRc 55~ HRc 60	HRc 60~ HRc 65	HRc 65~ HRc 70					
DIAMETER(mm)	RPM	FEED	RPM	FEED	RPM	FEED	RPM	FEED	RPM	FEED	RPM	FEED
3	21800	1400	17300	1000	11500	672	9500	416	7500	256	6400	184
4	16700	1440	13200	1040	8800	704	7200	432	5600	268	4750	192
5	15700	1600	12500	1200	8300	800	6400	464	5100	296	4450	216
6	13100	1560	10350	1120	6900	760	5300	448	4200	280	3700	208
8	9880	1504	7800	1080	5200	720	4000	416	3200	264	2800	192
10	7800	1400	6150	1008	4100	672	3200	384	2550	248	2200	176
12	6650	1400	5250	1008	3500	672	2650	384	2100	240	1860	176
16	4900	1200	3900	880	2600	584	2000	336	1600	216	1400	160
20	3900	1040	3100	776	2050	520	1600	304	1300	200	1100	144

RPM = rev. / min.
FEED = mm / min.

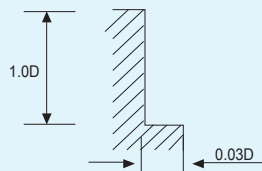

▣ ZR706, ZR736, ZE716, ZE726 series

MATERIAL	HARDENED STEELS HEAT RESISTANT STEELS		HARDENED STEELS		HARDENED STEELS		HARDENED STEELS		HARDENED STEELS		HARDENED STEELS	
HARDNESS	HRc 30~ HRc 40		HRc 40~ HRc 50		HRc 50~ HRc 55		HRc 55~ HRc 60		HRc 60~ HRc 65		HRc 65~ HRc 70	
DIAMETER(mm)	RPM	FEED	RPM	FEED	RPM	FEED	RPM	FEED	RPM	FEED	RPM	FEED
6	24800	5350	23500	4900	16000	4900	13500	3300	10500	2100	8000	1450
8	20000	5500	19000	5000	12000	4600	10000	3100	8000	2000	6000	1400
10	16000	4900	15500	4500	9500	4100	8000	2900	6400	1800	4800	1300
12	13000	4500	12500	4100	8000	3800	6600	2500	5300	1600	4000	1150
16	10000	4000	9700	3700	6000	3400	5000	2300	4000	1250	3000	870
20	8000	3350	7800	3400	4800	3200	4000	2100	3200	1020	2400	690

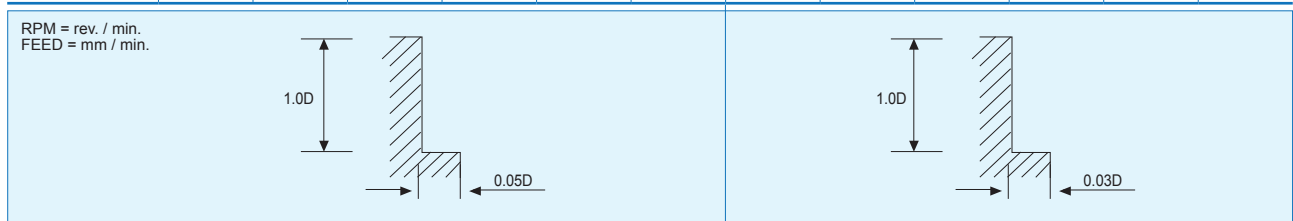

▣ ZSLNB series

MATERIAL	ALLOY STEELS HEAT RESISTANT STEELS			HARDENED STEELS			HARDENED STEELS			COPPER		
HARDNESS	HRc 30~ HRc 45			HRc 45~ HRc 55			HRc 55~ HRc 65					
DIAMETER(mm)	RPM	FEED	Ae(mm)	RPM	FEED	Ae(mm)	RPM	FEED	Ae(mm)	RPM	FEED	Ae(mm)
0.5	34100-49500	600-870	0.007-0.028	31900-35200	490-540	0.005-0.023	31900-35200	440-480	0.005-0.021	49000-50000	1100-1400	0.010-0.042
0.6	28600-40700	590-850	0.007-0.034	26400-29700	480-540	0.006-0.028	26400-29700	400-480	0.006-0.025	42000-50000	1100-1700	0.011-0.050
0.8	22000-30800	640-890	0.016-0.064	19800-22000	490-550	0.013-0.052	19800-22000	440-500	0.012-0.048	31000-50000	1100-2250	0.024-0.096
1.0	17600-24200	600-850	0.008-0.080	15400-17600	470-540	0.007-0.065	15400-17600	440-500	0.006-0.060	24000-49500	1100-2200	0.012-0.120
1.2	14300-18700	590-780	0.024-0.032	12000-14000	480-540	0.020-0.026	12000-14000	420-480	0.018-0.024	28500-38500	1480-1950	0.036-0.048
1.5	11000-14300	580-760	0.031-0.048	10000-11500	480-540	0.025-0.039	10000-11500	420-480	0.023-0.036	17000-28500	1100-1950	0.046-0.072
2.0	8500-11000	590-800	0.024-0.160	7900-8800	470-530	0.020-0.130	7900-8800	440-480	0.018-0.120	12600-24000	1100-2150	0.036-0.240
3.0	5700-8200	730-1000	0.064-0.24	5300-5800	590-650	0.052-0.195	5300-5800	550-620	0.048-0.120	11900-17000	1850-2700	0.096-0.360
4.0	4300-6200	680-990	0.080-0.320	3950-4400	550-620	0.065-0.260	3850-4400	530-570	0.060-0.240	6600-12500	1260-2500	0.120-0.480

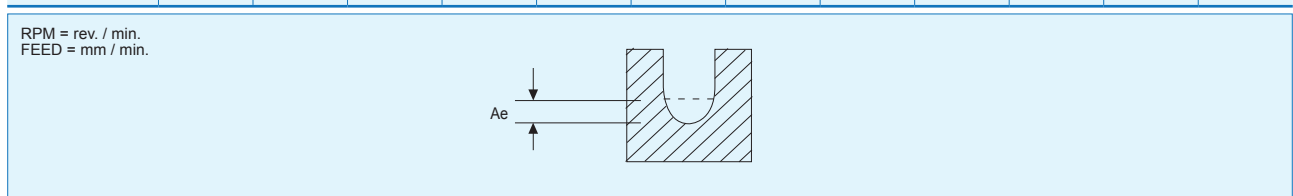

□ ZSLNS20, ZSLNS40 series

MATERIAL	ALLOY STEELS HEAT RESISTANT STEELS			HARDENED STEELS			HARDENED STEELS			COPPER		
HARDNESS	HRc 30~ HRc 45			HRc 45~ HRc 55			HRc 55~ HRc 65					
DIAMETER(mm)	RPM	FEED	Ae(mm)	RPM	FEED	Ae(mm)	RPM	FEED	Ae(mm)	RPM	FEED	Ae(mm)
0.4	34100-50000	350-590	0.005-0.028	30500-35200	295-340	0.003-0.020	18300-24600	120-200	0.002-0.012	48000-50000	790-920	0.008-0.048
0.5	25650-33000	370-470	0.006-0.035	23750-26000	285-315	0.004-0.025	14200-18000	115-130	0.003-0.015	44000-50000	800-1150	0.010-0.060
0.6	20900-35200	330-560	0.007-0.030	19900-22000	260-290	0.005-0.021	11900-15500	100-120	0.003-0.013	37500-50000	770-1250	0.011-0.051
0.8	16150-26400	360-590	0.009-0.040	15200-16700	280-310	0.006-0.028	9000-11700	110-125	0.004-0.017	28500-47000	770-1300	0.015-0.068
1.0	12300-18700	350-540	0.011-0.028	10500-11500	250-280	0.008-0.020	6300-8050	100-115	0.005-0.012	22500-34000	810-1300	0.018-0.048
1.2	10450-17600	350-590	0.025-0.070	9100-10000	250-280	0.015-0.042	5400-7000	100-115	0.009-0.026	22500-31500	950-1350	0.036-0.101
1.5	9100-17600	430-830	0.017-0.077	7000-8000	250-280	0.012-0.055	4300-5500	100-115	0.007-0.033	14500-25000	770-1320	0.028-0.132
2.0	6350-10550	340-570	0.021-0.140	6100-6700	270-300	0.015-0.100	3600-4700	100-120	0.009-0.060	11500-18500	770-1250	0.036-0.240
3.0	4300-7050	550-900	0.056-0.210	3990-4600	445-515	0.040-0.150	2400-3200	105-310	0.024-0.090	9000-13000	1400-2110	0.096-0.360
4.0	3200-5300	400-675	0.074-0.280	3000-3400	335-380	0.053-0.200	1800-2400	75-230	0.032-0.120	6750-9750	1050-1575	0.128-0.480

RPM = rev. / min.
FEED = mm / min.

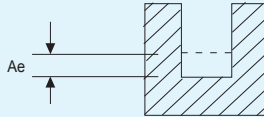

□ DB412 series

MATERIAL	HARDENED STEELS		HARDENED STEELS		HARDENED STEELS		HARDENED STEELS	
HARDNESS	HRc45 ~ HRc50		HRc50 ~ HRc55		HRc55 ~ HRc60		HRc60 ~ HRc70	
STRENGTH	1500 ~ 1750N/mm ²		1750 ~ 2000N/mm ²		2000 ~ 2080N/mm ²		2080N/mm ²	
DIAMETER(mm)	RPM	FEED	RPM	FEED	RPM	FEED	RPM	FEED
1	20000	460	20000	400	20000	350	20000	240
1.5	16300	640	16100	580	16000	570	14200	360
2	14500	800	14200	740	13850	760	11300	465
2.5	13400	950	13000	890	12600	920	9600	560
3	12700	1100	12300	1050	11800	1000	8400	660
4	10600	1100	10300	1050	9800	1000	6650	650
5	9400	1100	9050	1050	8600	950	5600	680
6	8600	1150	8250	1100	7850	950	4850	700
8	7000	1050	6700	1000	6350	950	3800	650
10	6050	1000	5800	960	5450	900	3200	620
12	5450	1000	5200	960	4900	900	2750	610

RPM=rev. / min.
FEED=mm / min.

Ae: D1~D4=0.05XD
D5~D8=0.025mm
D10~D20=0.30mm
Ap: D1~D20=0.1 X D

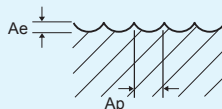

DB612 series ▶ Rib Processing

MATERIAL	NON-ALLOYED STEELS ALLOY STEELS · CAST IRON			ALLOY STEELS HEAT RESISTANT STEELS			HARDENED STEELS		
HARDNESS	~ HRc30			HRc30 ~ HRc45			HRc45 ~ HRc55		
STRENGTH	~ 1000N/mm ²			1000 ~ 1500N/mm ²			1500 ~ 2000N/mm ²		
DIAMETER(mm)	RPM	FEED	Ae(mm)	RPM	FEED	Ae(mm)	RPM	FEED	Ae(mm)
0.5	33000-42000	200~540	0.023~0.045	24000-30000	100~300	0.023~0.045	15000~19000	100~2000	0.005~0.009
0.6	33000-42000	250~700	0.027~0.054	24000-30000	120~385	0.027~0.054	15000~19000	120~250	0.005~0.011
0.8	33000-42000	250~700	0.036~0.072	24000-30000	120~385	0.036~0.072	15000~19000	120~250	0.007~0.014
1.0	30000-38000	275~770	0.045~0.090	22000~27000	140~430	0.045~0.090	13500~17500	140~280	0.009~0.018
1.2	25000~32000	275~860	0.055~0.100	18000~23000	140~430	0.055~0.100	11500~14500	140~280	0.010~0.022
1.4	22000~27000	275~860	0.062~0.125	16000~19000	140~430	0.062~0.125	10000~12500	140~280	0.012~0.025
1.5	20000~25000	275~860	0.070~0.135	14500~18500	140~430	0.070~0.135	9500~11500	140~280	0.014~0.028
1.6	19000~25000	275~860	0.075~0.145	14000~17500	140~430	0.075~0.145	9000~11000	140~280	0.015~0.030
1.8	18000~23000	275~860	0.080~0.160	12500~16000	140~430	0.080~0.160	8000~10000	140~280	0.016~0.032
2	16000~20000	275~860	0.090~0.180	11500~14500	140~430	0.090~0.180	7500~9000	140~280	0.018~0.035
3	11000~14000	275~860	0.135~0.270	7500~9500	140~430	0.135~0.270	5000~6000	140~280	0.028~0.055
4	9000~12000	275~860	0.180~0.360	6100~8200	140~430	0.180~0.360	4000~5000	140~280	0.035~0.070

RPM=rev. / min.
FEED=mm / min.

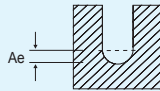

ZE612 series ▶ Rib Processing

MATERIAL	NON-ALLOYED STEELS ALLOY STEELS · CAST IRON			ALLOY STEELS HEAT RESISTANT STEELS			HARDENED STEELS		
HARDNESS	~ HRc30			HRc30 ~ HRc45			HRc45 ~ HRc55		
STRENGTH	~ 1000N/mm ²			1000 ~ 1500N/mm ²			1500 ~ 2000N/mm ²		
DIAMETER(mm)	RPM	FEED	Ae(mm)	RPM	FEED	Ae(mm)	RPM	FEED	Ae(mm)
0.4	33000-42000	220~490	0.007~0.018	24000-30000	100~375	0.007~0.018	15000~18000	35~100	0.004~0.008
0.5	33000-42000	220~190	0.009~0.022	24000-30000	100~375	0.009~0.022	15000~18000	35~100	0.004~0.009
0.6	33000-42000	275~630	0.011~0.026	24000-30000	120~485	0.011~0.026	15000~18000	45~120	0.005~0.011
0.7	33000-42000	275~630	0.012~0.031	24000-30000	120~485	0.012~0.031	15000~18000	45~120	0.006~0.013
0.8	28500~37000	310~700	0.014~0.035	20500~26000	130~530	0.014~0.035	13000~15500	50~140	0.007~0.015
0.9	26000~33000	310~800	0.030~0.060	19000~24000	180~600	0.030~0.060	11500~13500	60~145	0.008~0.016
1.0	24000~30000	310~900	0.045~0.090	16500~21000	210~660	0.045~0.090	10500~13500	75~145	0.009~0.018
1.2	19500~24000	310~990	0.055~0.100	14000~17000	210~660	0.055~0.100	9000~11000	75~145	0.010~0.022
1.4	17000~21000	310~990	0.062~0.125	12000~15000	210~660	0.062~0.125	7500~9500	75~145	0.012~0.025
1.5	15500~20000	310~990	0.070~0.135	11000~14500	210~660	0.070~0.135	7000~8500	75~145	0.014~0.028
1.6	15000~19000	310~990	0.075~0.145	11000~13500	210~660	0.075~0.145	6500~8500	75~145	0.015~0.030
1.8	14000~18000	310~990	0.080~0.160	10000~12000	210~660	0.080~0.160	6000~7500	75~145	0.016~0.032
2.0	12500~15500	310~990	0.090~0.180	9000~11000	210~660	0.090~0.180	5500~7000	75~145	0.018~0.035
2.5	10000~13000	310~990	0.112~0.235	7000~9000	210~660	0.112~0.235	4500~5500	75~145	0.022~0.045
3.0	8500~10500	310~990	0.135~0.270	6000~7500	210~660	0.135~0.270	3500~4500	75~145	0.028~0.055
4.0	6500~8000	310~990	0.180~0.360	4500~5500	210~660	0.180~0.360	2700~3500	75~145	0.036~0.072

RPM=rev. / min.
FEED=mm / min.

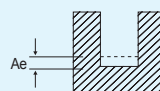

□ X-STAR series

WORKPIECE	LOW CARBON STEELS		LOW CARBON STEELS		MED ALLOY STEELS		MOLD&DIE STEELS		CAST IRON-GRAY		CAST IRON-GRAY	
HARDNESS	~HB175		~HB275		~HB275		~HB275		~HB200		~HB300	
DIAMETER(mm)	RPM	FEED	RPM	FEED	RPM	FEED	RPM	FEED	RPM	FEED	RPM	FEED
3	16500	335	13585	276	11320	230	5820	118	15360	300	7765	158
4	12340	326	10190	326	8520	340	4380	175	11550	462	5810	232
5	9895	502	8150	413	6790	345	3490	177	9215	468	4655	236
6	8250	586	6795	483	5660	403	2910	207	7680	546	3880	276
8	6185	754	5095	620	4245	517	2185	266	5760	702	2910	354
10	4950	955	4075	786	3395	656	1745	337	4610	889	2330	449
12	4125	963	3395	793	2830	661	1455	340	3840	897	1940	453
14	3535	890	2910	733	2425	592	1250	314	3290	829	1665	419
16	3095	817	2545	672	2125	561	1090	288	2880	761	1455	384
18	2750	809	2265	667	1885	556	970	285	2560	754	1295	381
20	2475	804	2040	662	1700	552	875	283	2305	749	1165	378
25	1975	631	1630	521	1360	435	700	230	1850	600	930	300

RPM = rev. / min.
FEED = mm / min.

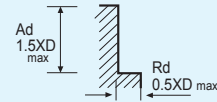
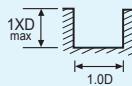

- Use a rigid and precise machines and holders.
- Use a suitable cutting oil.

□ X-STAR series

WORKPIECE	CAST IRON MALLEABLE		STAINLESS 300 SERIES		STAINLESS 400 SERIES		STAINLESS PH SERIES		TITANIUM ALLOYS		HIGH TEMP ALLOYS	
HARDNESS	~HB300		~HB275		~HB185		~HB325		~HB295		~HB300	
DIAMETER(mm)	RPM	FEED	RPM	FEED	RPM	FEED	RPM	FEED	RPM	FEED	RPM	FEED
3	4850	95	9705	175	13585	250	8085	125	9705	225	2590	50
4	3660	146	7245	290	10190	407	6050	242	7245	290	1910	76
5	2910	147	5820	300	8150	430	4850	250	5820	355	1550	75
6	2425	173	4850	355	6795	560	4045	300	4850	405	1295	75
8	1820	221	3640	405	5095	635	3030	355	3640	455	970	100
10	1455	280	2910	405	4075	635	2425	355	2910	455	775	100
12	1215	283	2425	405	3395	635	2020	355	2425	455	645	100
14	1040	262	2080	405	2910	635	1735	355	2080	455	555	100
16	910	240	1820	405	2545	635	1515	355	1820	455	485	100
18	810	238	1615	380	2265	560	1350	300	1615	405	430	100
20	730	236	1455	380	2040	560	1215	300	1455	405	390	100
25	585	187	1160	370	1630	560	970	300	1160	405	305	73

RPM = rev. / min.
FEED = mm / min.

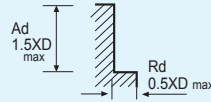
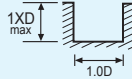

- Use a rigid and precise machines and holders.
- Use a suitable cutting oil.

□ X-STAR series ▶ Slotting

WORKPIECE	HARDENED STEELS	
HARDNESS	HRc30~45	
DIAMETER(mm)	RPM	FEED
3	6900	552
4	5175	414
5	4140	331
6	3450	414
8	2588	414
10	2070	414
12	1725	414
14	1479	414
16	1294	414
18	1150	368
20	1035	414
25	828	397

RPM = rev. / min.
FEED = mm / min.

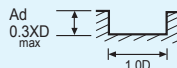

- Use a rigid and precise machines and holders.
- Use a suitable cutting oil.

□ X-STAR series ▶ Side Cutting

WORKPIECE HARDNESS	HARDENED STEELS HRc30~45	
DIAMETER(mm)	RPM	FEED
3	8493	679
4	6369	510
5	5096	611
6	4246	849
8	3185	764
10	2548	713
12	2123	764
14	1820	728
16	1592	701
18	1415	679
20	1274	662
25	1019	611

RPM = rev. / min.
FEED = mm / min.

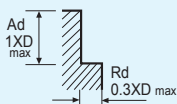

- Use a rigid and precise machines and holders.
- Use a suitable cutting oil.

□ X-STAR series ▶ High Speed Cutting

WORKPIECE HARDNESS	HARDENED STEELS HRc30~45	
DIAMETER(mm)	RPM	FEED
3	18047	2166
4	13535	1624
5	10828	1732
6	9023	2166
8	6768	1895
10	5414	1732
12	4512	1985
14	3867	1856
16	3384	1895
18	3008	1805
20	2707	1841
25	2166	1646

RPM = rev. / min.
FEED = mm / min.

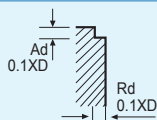

- Use a rigid and precise machines and holders.
- Use a suitable cutting oil.

DB312, DB402, DB502, DB512, DB522 series ▶ **General Cutting**

MATERIAL	NON-ALLOYED STEELS ALLOY STEELS · CAST IRON		ALLOY STEELS HEAT RESISTANT STEELS		HARDENED STEELS	
HARDNESS	~ HRc30		HRc30 ~ HRc40		HRc40 ~ HRc55	
STRENGTH	~ 1000N/mm ²		1000 ~ 1250N/mm ²		1500N/mm ²	
DIAMETER(mm)	RPM	FEED	RPM	FEED	RPM	FEED
1	16500	290	13300	230	6100	105
1.5	16500	405	12700	310	5590	140
2	15100	865	11200	565	4900	175
2.5	15100	865	11200	565	4900	175
3	13800	780	10500	530	4750	175
4	11000	850	8800	610	4410	205
5	9600	945	7600	665	3860	205
6	8900	1150	7200	955	3340	220
8	7500	1500	6050	1060	2590	255
10	6700	1750	5300	1170	2140	260
12	6150	2000	4900	1280	1840	280
16	5000	1950	3900	1220	1420	280
20	4350	1900	3400	1200	1170	290

RPM = rev. / min.
FEED = mm / min.

Ae : D1~D6=0.2mm
D8~D20=0.3mm
Ap : 0.2XD

Ae : D1~D6=0.2mm
D8~D20=0.3mm
Ap : 0.1XD

• Please reduce cutting speed around 20~30% from the above table or DB522 series.

DB312, DB402, DB502, DB512, DB522 series ▶ **High Speed Cutting**

MATERIAL	NON-ALLOYED STEELS · ALLOY STEELS · CAST IRON		ALLOY STEELS HEAT RESISTANT STEELS	
HARDNESS	~ HRc45		HRc30 ~ HRc40	
STRENGTH	~ 1500N/mm ²		1500 ~ 2000N/mm ²	
DIAMETER(mm)	RPM	FEED	RPM	FEED
1	26000	1500	26000	920
1.5	24000	1600	24000	990
2	22000	1700	22000	1080
2.5	22000	2000	20000	1130
3	22000	2300	17800	1200
4	22000	3350	14300	1300
5	22000	4150	12600	1380
6	22000	4600	11000	1440
8	17500	4600	8800	1440
10	14700	4450	7350	1380
12	12800	4450	6400	1330
16	10000	4000	5000	1150
20	8350	3650	4150	1060

RPM = rev. / min.
FEED = mm / min.

Ae : D1~D6=0.2mm
D8~D20=0.3mm
Ap : 0.2XD

Ae : D1~D6=0.2mm
D8~D20=0.3mm
Ap : 0.1XD

• Please reduce cutting speed around 20~30% from the above table or DB522 series.

DB514 series ▶ General Cutting

MATERIAL	NON-ALLOYED STEELS ALLOY STEELS · CAST IRON		ALLOY STEELS HEAT RESISTANT STEELS		HARDENED STEELS	
HARDNESS	~ HRc30		HRc30 ~ HRc40		HRc45 ~ HRc65	
STRENGTH	~ 1000N/mm ²		1000 ~ 1250N/mm ²		1500N/mm ²	
DIAMETER(mm)	RPM	FEED	RPM	FEED	RPM	FEED
3	13100	1020	10000	690	4520	220
4	10500	1110	8400	800	4200	270
5	9140	1230	7300	870	3680	270
6	7780	1260	6300	950	3160	280
8	5260	1430	4420	990	2100	280
10	4620	1530	3780	1070	1780	280
12	3780	1350	2940	990	1360	280
16	2740	1380	2320	980	1160	280
20	2100	1260	1900	950	840	280

<p>RPM = rev. / min. FEED = mm / min.</p> <p>Ae: D1~D6=0.2mm D8~D20=0.3mm Ap: 0.2 X D</p>		<p>Ae: D1~D6=0.2mm D8~D20=0.3mm Ap: 0.1 X D</p>
-------------------------------------------------------------------------------------------------------	--	---------------------------------------------------------

DB514 series ▶ High Speed Cutting

MATERIAL	NON-ALLOYED STEELS ALLOY STEELS · CAST IRON		HARDENED STEELS	
HARDNESS	~ HRc45		HRc45 ~ HRc65	
STRENGTH	~ 1500N/mm ²		~ 1500N/mm ²	
DIAMETER(mm)	RPM	FEED	RPM	FEED
3	21000	1500	17000	780
4	21000	2210	13660	870
5	21000	2700	12000	900
6	21000	3470	10500	940
8	15760	4260	7880	1110
10	13660	4580	6300	1260
12	10500	3950	5260	1260
16	8200	3950	3780	1060
20	6300	3780	2940	790

<p>RPM = rev. / min. FEED = mm / min.</p> <p>Ae: D1~D6=0.2mm D8~D20=0.3mm Ap: 0.05 X D</p>	
--------------------------------------------------------------------------------------------------------	--

DB532 series ▶ General Cutting

MATERIAL	NON-ALLOYED STEELS ALLOY STEELS · CAST IRON		ALLOY STEELS HEAT RESISTANT STEELS		HARDENED STEELS	
HARDNESS	~ HRc30		HRc30 ~ HRc40		HRc45 ~ HRc65	
STRENGTH	~ 1000N/mm ²		1000 ~ 1250N/mm ²		1500N/mm ²	
DIAMETER(mm)	RPM	FEED	RPM	FEED	RPM	FEED
3	35000	2800	33000	2600	12000	900
4	26000	2300	25000	2200	9000	800
5	21000	2100	20000	2000	7000	700
6	17000	1900	16000	1800	6000	650
8	13000	1700	12000	1600	4500	550
10	10500	1450	10000	1400	3500	500
12	9000	1400	8000	1300	3000	450
16	6000	1200	5500	1100	2000	400

RPM = rev. / min.
FEED = mm / min.

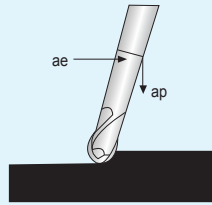

$$ae = 0.05 \times d1$$

$$ap = 0.02 \times d1$$

DB532 series ▶ High Speed Cutting

MATERIAL	NON-ALLOYED STEELS ALLOY STEELS · CAST IRON		ALLOY STEELS HEAT RESISTANT STEELS		HARDENED STEELS	
HARDNESS	~ HRc30		HRc30 ~ HRc40		HRc45 ~ HRc65	
STRENGTH	~ 1000N/mm ²		1000 ~ 1250N/mm ²		1500N/mm ²	
DIAMETER(mm)	RPM	FEED	RPM	FEED	RPM	FEED
3	47000	3700	44000	3500	17000	1400
4	35000	3200	33000	3000	13000	1200
5	28000	2800	27000	2600	10000	1100
6	23000	2600	22000	2400	8000	950
8	18000	2300	17000	2100	6000	850
10	14000	2000	13000	1900	5000	750
12	12000	1800	11000	1800	4000	700
16	9000	1600	8000	1500	3300	600

RPM = rev. / min.
FEED = mm / min.

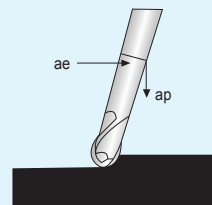

$$ae = 0.05 \times d1$$

$$ap = 0.02 \times d1$$

DB534 series ▶ General Cutting

MATERIAL	NON-ALLOYED STEELS ALLOY STEELS · CAST IRON		ALLOY STEELS HEAT RESISTANT STEELS		HARDENED STEELS	
HARDNESS	~ HRc30		HRc30 ~ HRc40		HRc45 ~ HRc65	
STRENGTH	~ 1000N/mm ²		1000 ~ 1250N/mm ²		1500N/mm ²	
DIAMETER(mm)	RPM	FEED	RPM	FEED	RPM	FEED
5	21000	4000	20000	4000	7000	1400
6	17000	4000	16000	3500	6000	1300
8	13000	3500	12000	3000	4500	1100
10	10500	3000	10000	2500	3500	1000
12	9000	2800	8000	2500	3000	950
16	6000	2800	5500	2200	2000	800

RPM = rev. / min.
FEED = mm / min.

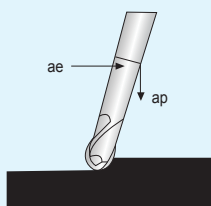

$$ae = 0.05 \times d1$$

$$ap = 0.02 \times d1$$

DB534 series ▶ High Speed Cutting

MATERIAL	NON-ALLOYED STEELS ALLOY STEELS · CAST IRON		ALLOY STEELS HEAT RESISTANT STEELS		HARDENED STEELS	
HARDNESS	~ HRc30		HRc30 ~ HRc40		HRc45 ~ HRc65	
STRENGTH	~ 1000N/mm ²		1000 ~ 1250N/mm ²		1500N/mm ²	
DIAMETER(mm)	RPM	FEED	RPM	FEED	RPM	FEED
5	28000	5600	27000	5300	11000	2100
6	23000	5100	22000	4900	9000	1900
8	18000	4600	17000	4300	7000	1700
10	14000	3900	13000	3700	5000	1400
12	12000	3700	11000	3500	4500	1300
16	9000	3100	8000	3000	3300	1100

RPM = rev. / min.
FEED = mm / min.

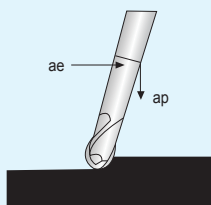

$$ae = 0.05 \times d1$$

$$ap = 0.02 \times d1$$

ZE302, ZE322, ZE402, ZE502, ZE522 series ▶ **General Cutting**

MATERIAL	ALLOY STEELS-HEAT RESISTANT STEELS		HARDENED STEELS		STAINLESS STEELS	
HARDNESS	HRc30 ~ HRc40		HRc40 ~ HRc50			
STRENGTH	1000 ~ 1250N/mm ²		1250 ~ 1750N/mm ²			
DIAMETER(mm)	RPM	FEED	RPM	FEED	RPM	FEED
2	9700	220	6350	135	5300	105
3	7500	240	4670	160	3880	135
4	6350	345	3880	205	3250	175
5	5300	370	3170	220	2650	185
6	4670	405	2830	255	2380	205
8	3530	435	2120	230	1760	205
10	2730	380	1680	185	1420	185
12	2310	320	1420	150	1140	150
16	1850	255	1140	125	890	125
20	1420	195	890	90	705	90
25	1150	150	705	80	580	70

RPM = rev. / min.
FEED = mm / min.

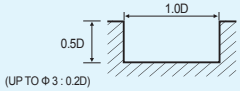

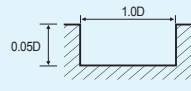

• Please reduce cutting speed around 20~30% from the above table for ZE522, ZE322 series.

ZE302, ZE322, ZE402, ZE502, ZE522 series ▶ **High Speed Cutting**

MATERIAL	ALLOY STEELS-HEAT RESISTANT STEELS		HARDENED STEELS				STAINLESS STEELS	
HARDNESS	HRc30 ~ HRc40		HRc40 ~ HRc50		HRc40 ~ HRc55			
STRENGTH	1000 ~ 1250N/mm ²		1250 ~ 1750N/mm ²		1750 ~ 2000N/mm ²			
DIAMETER(mm)	RPM	FEED	RPM	FEED	RPM	FEED	RPM	FEED
2	18000	665	11800	415	8700	175	9800	345
3	11000	655	6800	435	5600	185	6200	370
4	10300	725	6300	430	4300	185	5300	370
5	9350	715	5570	420	3700	185	4620	355
6	8200	750	4930	470	3250	185	4100	390
8	6300	770	3780	410	2470	185	3120	355
10	4830	750	2940	360	2000	160	2470	310
12	4100	750	2520	345	1680	160	2100	300
16	3260	715	2000	355	1890	150	1940	290
20	2520	665	1580	310	1680	150	1630	275
25	2000	635	1260	340	1570	150	1420	290

RPM = rev. / min.
FEED = mm / min.

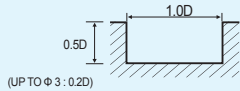

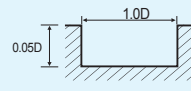

ZE503 series ▶ Side Cutting

MATERIAL	NON-ALLOY STEELS ALLOY STEELS-CAST IRON		ALLOY STEELS HEAT RESISTANT STEELS		STAINLESS STEELS		HARDENED STEELS		HARDENED STEELS	
HARDNESS	~ HRc30		HRc30 ~ HRc45				HRc45 ~ HRc55		HRc55 ~ HRc65	
STRENGTH	~ 1000N/mm ²		1000 ~ 1500N/mm ²				1500 ~ 2000N/mm ²		2000N/mm ² ~	
DIAMETER(mm)	RPM	FEED	RPM	FEED	RPM	FEED	RPM	FEED	RPM	FEED
6	5560	500	3360	310	2840	250	2000	60	1100	45
8	4200	530	2520	290	2100	265	1680	80	840	45
10	3260	460	2000	230	1680	230	1360	70	680	35
12	2740	390	1680	190	1360	180	1160	60	560	35
16	2200	310	1360	150	1060	150	900	45	440	20
18	1940	280	1210	135	950	130	790	35	380	20
20	1680	240	1060	120	840	115	680	30	320	20

RPM = rev. / min.
FEED = mm / min.

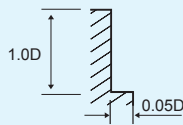

ZE503 series ▶ Slotting

MATERIAL	NON-ALLOY STEELS ALLOY STEELS-CAST IRON		ALLOY STEELS HEAT RESISTANT STEELS		STAINLESS STEELS		HARDENED STEELS		HARDENED STEELS	
HARDNESS	~ HRc30		HRc30 ~ HRc45				HRc45 ~ HRc55		HRc55 ~ HRc65	
STRENGTH	~ 1000N/mm ²		1000 ~ 1500N/mm ²				1500 ~ 2000N/mm ²		2000N/mm ² ~	
DIAMETER(mm)	RPM	FEED	RPM	FEED	RPM	FEED	RPM	FEED	RPM	FEED
6	5560	310	3360	200	2840	160	2000	50	1100	35
8	4200	340	2520	180	2100	160	1680	65	840	35
10	3260	300	2000	140	1680	145	1360	55	680	30
12	2740	250	1680	120	1360	120	1160	50	560	30
16	2200	200	1360	100	1060	100	900	35	440	20
18	1940	175	1210	85	950	85	790	30	380	20
20	1680	150	1060	70	840	70	680	25	320	20

RPM = rev. / min.
FEED = mm / min.

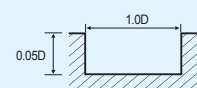
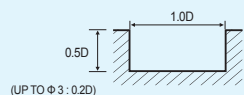

ZE304, ZE324, ZE404, ZE504, ZE524 series ▶ General Cutting

MATERIAL	NON-ALLOY STEELS ALLOY STEELS · CAST IRON		HARDENED STEELS				STAINLESS STEELS	
HARDNESS	~HRc30		HRc30 ~ HRc45		HRc45 ~ HRc55			
STRENGTH	~1000N/mm ²		1000 ~ 1500N/mm ²		1500 ~ 2000N/mm ²			
DIAMETER(mm)	RPM	FEED	RPM	FEED	RPM	FEED	RPM	FEED
2	12100	320	7900	195	2700	47	6600	160
3	9400	370	5840	230	2000	58	4850	195
4	7900	655	4850	405	1500	58	4070	320
5	6600	690	3970	415	1300	58	3320	345
6	5830	760	3530	470	1150	58	2980	380
8	4410	815	2650	435	880	58	2200	405
10	3420	700	2100	345	720	46	1760	345
12	2880	600	1760	290	590	46	1430	275
16	2310	470	1430	230	460	29	1150	230
20	1760	370	1110	185	340	29	880	175
25	1430	290	880	150	270	23	715	140

RPM = rev. / min.
FEED = mm / min.

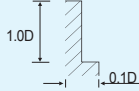

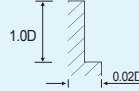

• Please reduce cutting speed around 20~30% from the above table for ZE524 & ZE324 series.

ZE304, ZE324, ZE404, ZE504, ZE524 series ▶ High Speed Cutting

MATERIAL	NON-ALLOY STEELS ALLOY STEELS · CAST IRON		HARDENED STEELS				STAINLESS STEELS	
HARDNESS	~HRc30		HRc30 ~ HRc45		HRc45 ~ HRc55			
STRENGTH	~1000N/mm ²		1000 ~ 1500N/mm ²		1500 ~ 2000N/mm ²			
DIAMETER(mm)	RPM	FEED	RPM	FEED	RPM	FEED	RPM	FEED
2	31400	1230	23500	520	12600	275	21600	465
3	19300	1210	13600	735	8900	390	13500	660
4	18100	1330	12600	865	7090	465	11800	775
5	16400	1310	11100	1010	6040	530	10300	910
6	14400	1380	9900	1100	5300	580	9100	990
8	11000	1430	7600	1090	3990	575	6900	980
10	8500	1380	5880	1110	3150	580	5420	1000
12	7200	1380	5040	1090	2620	575	4600	985
16	5700	1320	3990	1010	2000	535	3590	910
20	4400	1270	3150	930	1580	490	2840	840
25	3500	1170	2520	755	1260	390	2270	680

RPM = rev. / min.
FEED = mm / min.

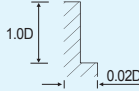

ZE506, ZE516 series ▶ General Speed Cutting

MATERIAL	NON-ALLOY STEELS ALLOY STEELS · CAST IRON		ALLOY STEELS HEAT RESISTANT STEELS		HARDENED STEELS		HARDENED STEELS	
HARDNESS	~ HRc30		HRc30 ~ HRc50		HRc50 ~ HRc60		HRc60 ~ HRc65	
STRENGTH	~ 1000N/mm ²		1000 ~ 1750N/mm ²		1750 ~ 2080N/mm ²		2080N/mm ²	
DIAMETER(mm)	RPM	FEED	RPM	FEED	RPM	FEED	RPM	FEED
6	5560	2000	3880	1370	1580	210	1100	130
8	4200	2000	2940	1370	1160	210	840	130
10	3360	2000	2320	1370	1000	210	680	130
12	2840	1680	2000	1160	840	180	560	110
16	2100	1260	1480	880	640	130	420	70
20	1680	1010	1160	690	500	110	320	60
25	1500	900	1100	600	430	90	260	50

RPM = rev. / min. FEED = mm / min.				
---------------------------------------	--	--	--	--

ZE506, ZE516 series ▶ High Speed Cutting

MATERIAL	HEAT RESISTANT STEELS HARDENED STEELS		HARDENED STEELS		HARDENED STEELS	
HARDNESS	~ HRc50		HRc50 ~ HRc60		HRc60 ~ HRc65	
STRENGTH	1750N/mm ²		1750~2080N/mm ²		2080N/mm ² ~	
DIAMETER(mm)	RPM	FEED	RPM	FEED	RPM	FEED
6	16800	6090	8400	3050	4200	1470
8	12600	6090	6300	3050	3160	1470
10	9980	5990	5040	3050	2520	1470
12	8400	5040	4200	2520	2100	1260
16	6300	3780	3160	1890	1580	950
20	5040	3050	2520	1470	1260	760
25	4500	2750	2200	1300	1120	670

RPM = rev. / min. FEED = mm / min.			
---------------------------------------	--	--	--

• Please reduce cutting speed around 20~30% from the above table or Extra long series.

□ ZM502, ZM522 series

MATERIAL	NON-ALLOYED STEELS ALLOY STEELS · CAST IRON		ALLOY STEELS HEAT RESISTANT STEELS		HARDENED STEELS	
HARDNESS	~ HRc30		HRc30 ~ HRc45		HRc45 ~ HRc55	
STRENGTH	~ 1000N/mm ²		1000~ 1500N//mm ²		1500 ~ 2000N//mm ²	
DIAMETER(mm)	RPM	FEED	RPM	FEED	RPM	FEED
2	6300	60	5040	50	3150	25
3	4410	70	3570	60	2200	30
4	3570	85	2840	70	1790	35
5	3050	105	2420	85	1580	40
6	2630	125	2100	105	1370	50
8	2000	135	1580	105	1050	50
10	1680	135	1370	105	840	50
12	1370	105	1160	95	700	40
16	1160	95	890	75	560	35
20	840	70	680	50	420	25

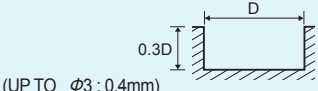
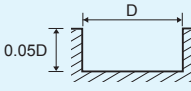
RPM=rev. / min. FEED=mm / min.		
	(UP TO φ3 : 0.4mm)	

□ ZM504, ZM524 series

MATERIAL	NON-ALLOY STEELS ALLOY STEELS · CAST IRON		ALLOY STEELS HEAT RESISTANT STEELS		HARDENED STEELS		HARDENED STEELS	
HARDNESS	~ HRc30		HRc30 ~ HRc45		HRc45 ~ HRc55		HRc55 ~ HRc65	
STRENGTH	~ 1000N/mm ²		1000 ~ 1500N//mm ²		1500 ~ 2000N/mm ²		2000N/mm ²	
DIAMETER(mm)	RPM	FEED	RPM	FEED	RPM	FEED	RPM	FEED
2	6300	100	5040	80	3150	45		
3	4410	115	3570	100	2200	55	1890	30
4	3570	140	2840	115	1790	60	1470	35
5	3050	180	2420	140	1580	70	1260	40
6	2630	215	2100	180	1370	90	1160	50
8	2000	230	1580	180	1050	90	840	50
10	1680	230	1370	180	840	90	670	50
12	1370	180	1160	160	700	70	560	40
16	1160	160	890	125	560	60	440	35
20	840	115	680	90	420	45	340	25

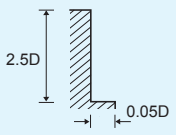
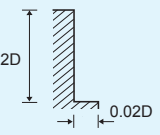
RPM=rev. / min. FEED=mm / min.		

▣ ZR322, ZR502, ZR512, ZR522 series ▶ Side Cutting

MATERIAL	NON-ALLOYED STEELS ALLOY STEELS · CAST IRON		ALLOY STEELS HEAT RESISTANT STEELS		HARDENED STEELS	
HARDNESS	~ HRc30		HRc30 ~ HRc45		HRc45 ~ HRc55	
STRENGTH	~ 1000N/mm ²		1000~ 1500N//mm ²		1500 ~ 2000N//mm ²	
DIAMETER(mm)	RPM	FEED	RPM	FEED	RPM	FEED
3	6950	195	4500	150	3300	100
4	5600	240	3600	170	2700	105
5	4800	250	3050	210	2350	125
6	4150	250	2650	210	2050	125
8	3150	265	2000	210	1600	125
10	2150	265	1700	210	1250	125
12	1800	210	1500	185	1050	105
16	1800	185	1100	140	840	90
20	1300	130	860	105	625	65

RPM=rev. / min.
FEED=mm / min.

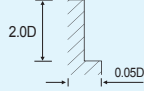
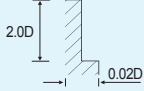
▣ ZR322, ZR502, ZR512, ZR522 series ▶ Slotting

MATERIAL	NON-ALLOYED STEELS ALLOY STEELS · CAST IRON		ALLOY STEELS HEAT RESISTANT STEELS		HARDENED STEELS	
HARDNESS	~ HRc30		HRc30 ~ HRc45		HRc45 ~ HRc55	
STRENGTH	~ 1000N/mm ²		1000~ 1500N//mm ²		1500 ~ 2000N//mm ²	
DIAMETER(mm)	RPM	FEED	RPM	FEED	RPM	FEED
3	6950	160	4500	80	3300	55
4	5600	195	3600	100	2700	60
5	4800	240	3050	115	2350	75
6	4150	290	2650	145	2050	90
8	3150	210	2000	145	1600	90
10	2150	250	1700	140	1250	90
12	1800	200	1500	135	1050	75
16	1800	215	1100	100	840	60
20	1300	160	860	70	625	45

RPM=rev. / min.
FEED=mm / min.

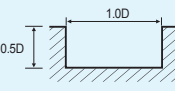

□ ZR324, ZR504, ZR514, ZR524 series

MATERIAL	NON-ALLOYED STEELS ALLOY STEELS · CAST IRON		ALLOY STEELS HEAT RESISTANT STEELS		HARDENED STEELS	
HARDNESS	~ HRc30		HRc30 ~ HRc45		HRc45 ~ HRc55	
STRENGTH	~ 1000N/mm ²		1000~ 1500N//mm ²		1500 ~ 2000N//mm ²	
DIAMETER(mm)	RPM	FEED	RPM	FEED	RPM	FEED
3	6950	195	4500	150	3300	100
4	5600	240	3600	170	2700	105
5	4800	250	3050	210	2350	125
6	4150	250	2650	210	2050	125
8	3150	265	2000	210	1600	125
10	2150	265	1700	210	1250	125
12	1800	210	1500	185	1050	105
16	1880	185	1100	140	840	90
20	1300	130	860	105	625	65

RPM=rev. / min.
FEED=mm / min.

□ ZR304H, ZR324H series

MATERIAL	NON-ALLOYED STEELS ALLOY STEELS · CAST IRON		ALLOY STEELS HEAT RESISTANT STEELS		HARDENED STEELS	
HARDNESS	~ HRc30		HRc30 ~ HRc45		HRc45 ~ HRc55	
STRENGTH	~ 1000N/mm ²		1000~ 1500N//mm ²		1500 ~ 2000N//mm ²	
DIAMETER(mm)	RPM	FEED	RPM	FEED	RPM	FEED
6	7000	910	4200	560	3000	140
8	5300	980	3200	530	2500	190
10	4100	840	2500	410	2050	165
12	3500	730	2100	340	1700	140

RPM=rev. / min.
FEED=mm / min.

▣ ZF60, ZF61 series

MATERIAL	NON-ALLOY STEELS ALLOY STEELS-CAST IRON		ALLOY STEELS HEAT RESISTANT STEELS		STAINLESS STEELS		HARDENED STEELS		HARDENED STEELS	
HARDNESS	~ HRc30		HRc30 ~ HRc38		HRc38 ~ HRc45		HRc45 ~ HRc55		HRc55 ~ HRc65	
STRENGTH	~ 1000N/mm ²		1000 ~ 1200N/mm ²		1200 ~ 1400N/mm ²		1400 ~ 2000N/mm ²		2000N/mm ² ~	
DIAMETER(mm)	RPM	FEED	RPM	FEED	RPM	FEED	RPM	FEED	RPM	FEED
6	15600	2320	12400	840	8400	570	3400	260	2400	190
8	11600	2320	9200	840	6300	570	2400	240	1800	180
10	9200	2320	7600	840	5100	570	2000	290	1300	190
12	8000	2400	6000	800	4200	570	1680	260	1200	190
14	6800	2400	5200	840	3600	570	1400	200	900	130
16	6000	2400	4800	760	3300	510	1200	160	800	110
18	5200	2320	4400	720	2700	420	1100	150	700	100
20	4800	2160	3600	560	2400	360	1000	150	660	100
25	4300	2150	3200	620	2160	410	900	160	600	100

RPM=rev. / min.
FEED=mm / min.

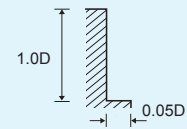
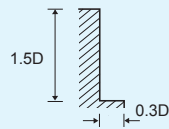

PK503 series

MATERIAL		Alloy Steels-High Carbon Steels			Prehardened Steels-Tool steels HRC30 ~ 40			
(V)m/min		130 ~ 150			100 ~ 120			
Diameter (mm)	(r.p.m.)	fz			(r.p.m.)	fz		
		Slot	Side Cutting	Slot		Slot	Side Cutting	Slot
6	7,400	0.030	0.045	0.018	5,800	0.025	0.030	0.012
8	5,600	0.035	0.062	0.025	4,400	0.030	0.045	0.018
10	4,600	0.045	0.075	0.030	3,500	0.040	0.048	0.019
12	3,700	0.050	0.087	0.035	3,000	0.045	0.052	0.020
14	3,200	0.055	0.090	0.036	2,500	0.053	0.056	0.022
16	2,800	0.055	0.090	0.036	2,200	0.060	0.060	0.024
20	2,200	0.080	0.095	0.038	1,800	0.066	0.066	0.026
	ap		1.0D	1.0D		1.0D	1.0D	0.5D
	ae		1.0D	0.5D		1.0D	0.3D	1.0D

MATERIAL		SUS304-316-Prehardened Steels HRC40 ~ 45			Titanium Alloy			
(V)m/min		50 ~ 70			30 ~ 50			
Diameter (mm)	(r.p.m.)	fz			(r.p.m.)	fz		
		Slot	Side Cutting	Slot		Slot	Side Cutting	Slot
6	3,200	0.020	0.030	0.012	2,100	0.017	0.020	0.008
8	2,400	0.030	0.040	0.016	1,600	0.025	0.025	0.010
10	1,900	0.040	0.055	0.022	1,300	0.035	0.040	0.016
12	1,600	0.045	0.065	0.026	1,100	0.040	0.050	0.020
14	1,360	0.048	0.070	0.028	900	0.043	0.053	0.021
16	1,200	0.050	0.075	0.030	800	0.045	0.055	0.022
20	1,000	0.052	0.083	0.033	600	0.050	0.057	0.023
	ap		0.5D	1.0D		0.5D	1.0D	0.5D
	ae		1.0D	0.5D		1.0D	0.3D	1.0D

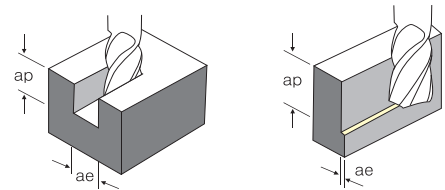

TX202, 222, 302 ...series

MATERIAL	NON - ALLOYED STEELS ALLOY STEELS TOOLS STEELS		ALLOY STEELS HEAT RESISANT STEELS		STAINLESS STEELS		CAST IRON		ALUMINUM ALLOYS		COPPER, BRASS NON-FERROUS METALS	
HARDNESS	~ HRc 30		HRc 30 ~ HRc 45									
STRENGTH	~ 1000N/mm ²		1000 ~ 1500N/mm ²									
DIAMETER(mm)	RPM	FEED	RPM	FEED	RPM	FEED	RPM	FEED	RPM	FEED	RPM	FEED
1	14300	105	8500	65	7150	50	18700	205	44000	330	24700	200
1.5	9350	150	5550	85	5600	80	12100	205	27500	385	20300	300
2	7850	160	5150	100	4300	80	9350	220	22000	460	16500	340
3	6100	180	3800	120	3150	100	6050	220	15400	460	11000	340
4	5150	255	3150	155	2650	130	4600	220	11000	460	8800	340
5	4300	270	2550	160	2150	135	3650	220	9150	460	6800	340
6	3800	300	2300	190	1950	155	2950	255	7600	485	5700	375
8	2850	325	1700	170	1450	155	2200	275	5700	485	4400	375
10	2200	280	1350	135	1150	135	1850	285	4600	485	3400	375
12	1850	240	1150	110	950	110	1450	295	3750	485	2850	375
14	1700	215	1050	100	850	100	1300	310	3300	485	2400	375
16	1500	185	950	95	700	95	1100	320	2850	485	2200	375
20	1150	145	700	70	550	70	900	340	2200	485	1700	375

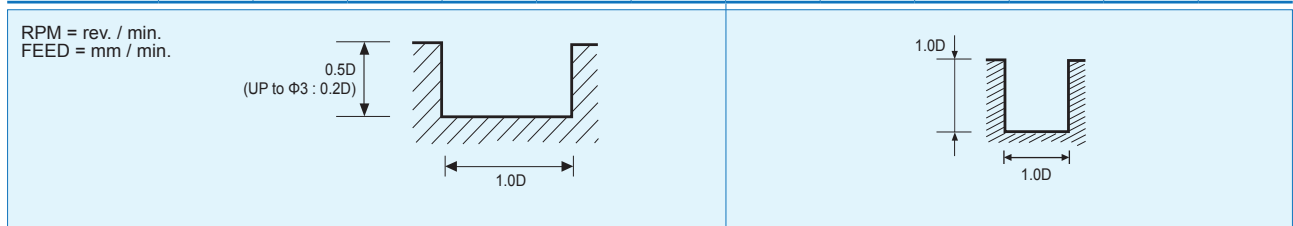

※ The FEED for long & extra long types, should be reduced by around 50%

□ TX204, 224, 304 ...series

MATERIAL	NON - ALLOYED STEELS ALLOY STEELS TOOLS STEELS		ALLOY STEELS HEAT RESISANT STEELS		STAINLESS STEELS		CAST IRON		ALUMINUM ALLOYS		COPPER, BRASS NON-FERROUS METALS	
HARDNESS	~ HRc 30		HRc 30 ~ HRc 45									
STRENGTH	~ 1000N/mm ²		1000 ~ 1500N/mm ²									
DIAMETER(mm)	RPM	FEED	RPM	FEED	RPM	FEED	RPM	FEED	RPM	FEED	RPM	FEED
1	17600	150	10250	85	8650	75	18700	620	44000	1050	24700	605
1.5	11800	215	7050	115	7050	120	12100	620	27500	1160	20300	910
2	9850	240	6450	145	5350	120	9350	640	22000	1320	16500	1035
3	7600	270	4750	170	3950	145	6050	640	15400	1320	11000	1035
4	6450	485	3950	300	3300	240	4600	640	11000	1320	8800	1035
5	5350	510	3200	305	2700	255	3650	640	9150	1320	6800	1035
6	4750	560	2850	350	2400	280	2950	770	7600	1430	5700	1100
8	3550	605	2150	325	1800	300	2200	815	5700	1430	4400	1100
10	2750	520	1700	255	1450	255	1850	860	4600	1430	3400	1100
12	2350	440	1450	215	1150	205	1450	900	3750	1430	2850	1100
14	2100	395	1300	195	1050	190	1300	945	3300	1430	2400	1100
16	1850	350	1150	170	950	170	1100	970	2850	1430	2200	1100
20	1450	270	900	135	700	130	900	1035	2200	1430	1700	1100

RPM = rev. / min.
FEED = mm / min.

※ The FEED for long & extra long types, should be reduced by around 50%

TXB202, 222, 232, 302 ...series

MATERIAL	CARBON STEELS ALLOY STEELS TOOLS STEELS		CARBON STEELS ALLOY STEELS TOOLS STEELS		HARDENED STEELS		CAST IRON		ALUMINUM ALLOYS	
	~ HRc 30		HRc 30 ~ HRc 45		HRc 45 ~ HRc 50					
STRENGTH	~ 1000N/mm ²		1000 ~ 1500N/mm ²		1500N/mm ²					
DIAMETER(mm)	RPM	FEED	RPM	FEED	RPM	FEED	RPM	FEED	RPM	FEED
2	12350	640	9150	415	4000	125	10500	220	30800	395
3	11400	575	8550	390	3800	125	7050	230	20500	395
4	8950	630	7150	450	3600	150	5150	285	15400	395
5	7800	700	6200	490	3100	150	4150	330	12100	470
6	7250	870	5900	705	2700	160	3400	360	10300	470
8	6100	1090	4900	785	2050	190	2500	460	7900	540
10	5450	1330	4350	870	1750	190	2050	460	6150	540
12	4990	1500	3950	950	1500	210	1750	460	5150	630
14	4530	1495	3600	925	1300	210	1400	460	4300	630
16	4085	1470	3200	905	1150	210	1300	460	3850	540
18	3800	1425	3000	890	1050	210	1100	460	3400	540
20	3550	1425	2800	885	950	210	1050	420	2950	540

RPM = rev. / min.
FEED = mm / min.

Ae: D1~D6=0,2mm
D8~D20=0,3mm
Ap: 0,2D

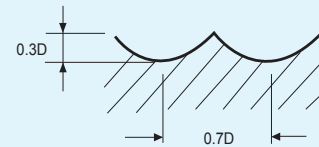
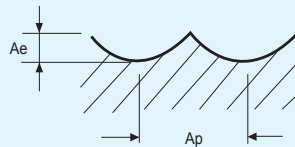

※ The FEED for long & extra long types, should be reduced by around 50%

SM503 series ▶ Slotting

MATERIAL	CARBON STEELS · ALLOY STEELS · TOOLS STEELS						CAST IRON		STAINLESS STEEL		COPPER ALLOYS		TITANIUM ALLOYS		INCONEL	
HARDNESS	~HRc2040		HRc20 ~ HRc30		HRc30 ~ HRc45											
STRENGTH	1000N/mm ²		800 ~ 1000N/mm ²		1500 ~ 1500N/mm ²											
DIAMETER(mm)	RPM	FEED	RPM	FEED	RPM	FEED	RPM	FEED	RPM	FEED	RPM	FEED	RPM	FEED	RPM	FEED
3	10080	950	7750	740	5550	395	6700	520	5550	320	8300	360	5550	395	2200	100
4	7550	1400	5850	1100	4200	595	5050	550	4200	320	6200	400	4200	595	1650	105
6	5050	1650	3850	1250	2800	700	3350	660	2800	370	4100	440	2800	700	1150	130
8	3750	1700	2950	1330	2100	710	2500	665	2100	375	3100	500	2100	710	850	120
10	3050	1650	2300	1250	1650	655	2000	630	1650	355	2500	530	1650	665	650	120
12	2500	1500	2000	1200	1350	605	1650	570	1350	320	2000	550	1350	605	555	110

RPM=rev. / min.
FEED=mm / min.

(UP TO Ø3 : 0.4mm)

SM503 series ▶ Side Cutting

MATERIAL	CARBON STEELS · ALLOY STEELS · TOOLS STEELS						CAST IRON		STAINLESS STEEL		COPPER ALLOYS		TITANIUM ALLOYS		INCONEL	
HARDNESS	~HRc20		HRc20 ~ HRc30		HRc30 ~ HRc45											
STRENGTH	1000N/mm ²		800 ~ 1000N/mm ²		1500 ~ 1500N/mm ²											
DIAMETER(mm)	RPM	FEED	RPM	FEED	RPM	FEED	RPM	FEED	RPM	FEED	RPM	FEED	RPM	FEED	RPM	FEED
3	10080	1080	7750	850	5550	450	6700	605	5550	365	8300	390	5550	450	2200	110
4	7550	1630	5850	1260	4200	680	5050	630	4200	365	6200	440	4200	680	1650	125
6	5050	1910	3850	1470	2800	810	3350	755	2800	430	4100	490	2800	810	1150	150
8	3750	1950	2950	1500	2100	810	2500	770	2100	430	3100	550	2100	810	850	140
10	3050	1890	2300	1400	1650	775	2000	720	1650	415	2500	570	1650	775	650	140
12	2500	1700	2000	1340	1350	700	1650	665	1350	365	2000	620	1350	700	555	125

RPM=rev. / min.
FEED=mm / min.

SM504 series

MATERIAL	ALLOY STEELS · CAST IRON		STAINLESS STEELS 300 SERIES TITANIUM		STAINLESS STEELS 400 SERIES	
HARDNESS	~HB 230					
DIAMETER(mm)	RPM	FEED	RPM	FEED	RPM	FEED
3	13500	275	6690	105	9350	145
4	10100	370	5050	135	7000	185
5	8090	410	4050	165	5600	230
6	6750	480	3350	190	4700	265
8	5050	620	2500	250	3500	340
10	4050	780	2050	320	2800	430
12	3370	750	1680	310	2350	435
14	2890	670	1400	280	2000	405
16	2500	630	1250	265	1750	370
18	2250	630	1100	260	1550	365
20	2000	620	1000	260	1400	365

RPM=rev. / min.
FEED=mm / min.

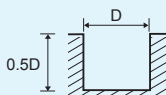

BC502 series

MATERIAL		UNALLOYED COPPER			
R	DIAMETER(mm)	RPM	FEED	Rd	Ad
0.5	1	41000	1660	0.040	0.063
0.75	1.5	27000	1830	0.068	0.087
1	2	20000	1780	0.089	0.112
1.25	2.5	16000	1840	0.115	0.090
1.5	3	13000	2220	0.171	0.168
2	4	10000	2080	0.208	0.200
2.5	5	8300	1990	0.240	0.200
3	6	6900	1940	0.281	0.250
4	8	5720	1000	0.175	0.400
5	10	4550	700	0.154	0.500
6	12	3770	600	0.159	0.600

RPM=rev. / min.
FEED=mm / min.

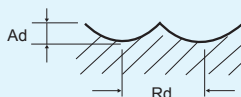

ZF62 series ▶ Slotting

MATERIAL	NON - ALLOYED STEELS ALLOY STEELS · CAST IRON		ALLOY STEELS HEAT RESISTANT STEELS		STAINLESS STEELS		INCONEL	
HARDNESS	~ HRc30		HRc30 ~ HRc45					
STRENGTH	~ 1000N/mm ²		1000 ~ 1500N/mm ²					
DIAMETER(mm)	RPM	FEED	RPM	FEED	RPM	FEED	RPM	FEED
6	16380	2680	13020	970	8820	670	3000	285
8	12180	2680	9660	970	6615	670	2250	270
10	9660	2680	7980	970	5355	660	1625	285
12	8400	2770	6300	925	4410	660	1500	285
16	6300	2770	5040	880	3465	590	1000	165
20	5040	2495	3780	650	2520	415	825	150

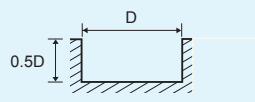
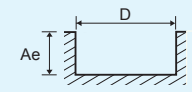
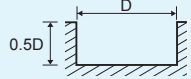
<p>RPM=rev. / min. FEED=mm / min.</p> 	 <p>Ae : $\phi 4 \sim \phi 10 = 0.25 \times D$ $\phi 12 \sim \phi 16 = 0.15 \times D$ $\phi 18 \sim \phi 20 = 0.10 \times D$</p>	
-----------------------------------------------------------------------------------------------------------------------------	---------------------------------------------------------------------------------------------------------------------------------------------------------------------------------------------------------------------------------------------------------------	-------------------------------------------------------------------------------------

ZF62 series ▶ Side Cutting

MATERIAL	NON - ALLOYED STEELS ALLOY STEELS · CAST IRON		ALLOY STEELS HEAT RESISTANT STEELS		STAINLESS STEELS		INCONEL	
HARDNESS	~ HRc30		HRc30 ~ HRc45					
STRENGTH	~ 1000N/mm ²		1000 ~ 1500N/mm ²					
DIAMETER(mm)	RPM	FEED	RPM	FEED	RPM	FEED	RPM	FEED
6	16380	2680	13020	970	8820	670	3000	285
8	12180	2680	9660	970	6615	670	2250	270
10	9660	2680	7980	970	5355	660	1625	285
12	8400	2770	6300	925	4410	660	1500	285
16	6300	2770	5040	880	3465	590	1000	165
20	5040	2495	3780	650	2520	415	825	150

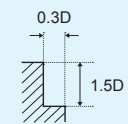
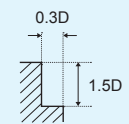
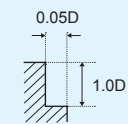
<p>RPM=rev. / min. FEED=mm / min.</p> 		
-------------------------------------------------------------------------------------------------------------------------------	--------------------------------------------------------------------------------------	---------------------------------------------------------------------------------------

RC502 series

MATERIAL	UNALLOYED COPPER			
DIAMETER(mm)	RPM	FEED	RPM	FEED
3	44500	2350	50000	3700
4	33400	2100	50000	4700
6	22300	2100	33400	4900
8	16700	2100	25000	4700
10	13370	2100	20000	4800
12	11100	2100	16700	4700

RPM=rev. / min.
FEED=mm / min.

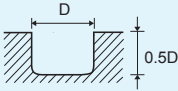
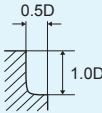
AE302 series

MATERIAL	ALLOY STEELS · CAST IRON		ALUMINIUM	
HARDNESS	~HB 230			
DIAMETER(mm)	RPM	FEED	RPM	FEED
1.0	16870	505	16870	845
1.5	13150	525	13150	790
2.0	11300	565	11300	790
2.5	10565	635	10565	845
3.0	10000	700	10000	900
4.0	10000	900	10000	1100
5.0	10000	1000	10000	1300
6.0	10000	1200	10000	1500
7.0	8850	1240	8850	1505
8.0	8000	1400	8000	1800
9.0	8000	1550	8000	1680
10.0	8000	1700	8000	2100
12.0	8000	2100	8000	2600
14.0	6000	1800	6000	2200
16.0	6000	1900	6000	2400
18.0	4000	1400	4000	1800
20.0	4000	1600	4000	1900

RPM=rev. / min.
FEED=mm / min.

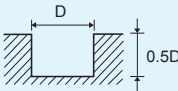

A : $\phi 3 \sim \phi 10 = 0.25 \times D$
 $\phi 12 \sim \phi 20 = 0.5 \times D$

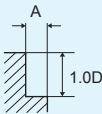

▣ AE303, AE323 series ▶ Side Cutting

MATERIAL	ALUMINIUM · NONFERROUS METALS	
DIAMETER(mm)	RPM	FEED
3	7000	455
4	7000	546
5	7000	651
6	7000	756
8	5600	861
10	5600	1050
12	5600	882
14	4200	1106
16	4200	1211
18	2800	910
20	2800	956

RPM=rev. / min.
FEED=mm / min.

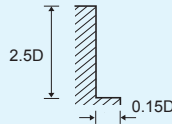

- Please reduce cutting speed around 20~30% from the above table or AE323 series.

▣ AE303, AE323 series ▶ Slotting

MATERIAL	ALUMINIUM · NONFERROUS METALS	
DIAMETER(mm)	RPM	FEED
3	7000	350
4	7000	441
5	7000	504
6	7000	606
8	5600	700
10	5600	854
12	5600	1050
14	4200	903
16	4200	945
18	2800	700
20	2800	805

RPM=rev. / min.
FEED=mm / min.

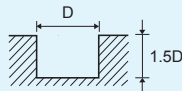

AF303 series ▶ Slotting

MATERIAL	ALUMINIUM · NONFERROUS METALS			
DIAMETER(mm)	RPM	FEED	RPM	FEED
6	10500	800	13500	1050
8	8000	700	10500	900
10	6500	750	8500	950
12	5250	800	6800	1050
16	4000	800	5200	1050
20	3200	800	4200	1050

RPM=rev. / min.
FEED=mm / min.

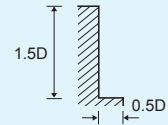
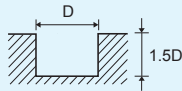

G series

MATERIAL	GRAPHITE	
DIAMETER(mm)	RPM	FEED
R0.5	16000	480
R0.75	16000	640
R1	16000	800
R1.5	16000	1450
R2	16000	2100
R3	15000	2950
R4	13000	3000
R5	11500	3050
R6	10500	3150
R8	8555	2960

RPM=rev. / min.
FEED=mm / min.

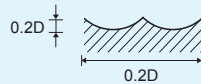

□ EB302, EB322, BB302 series

Work Material	SM50C,SCM,GC (~HRc30)		STD61,STD11 (HRc30~HRc45)		STD61 (HRc45~HRc55)		
	DIAMETER (mm)	RPM (mm ⁻¹)	FEED (mm/rev)	RPM (mm ⁻¹)	FEED (mm/rev)	RPM (mm ⁻¹)	FEED (mm/rev)
	20	1600	152	950	88	560	44
	25	1300	136	750	72	450	36
	30	1100	120	650	64	370	32
	40	800	96	500	56	280	24
	50	650	88	400	48	220	20

□ EB304, EB324 series

Work Material	SM50C,SCM,GC (~HRc30)		STD61,STD11 (HRc30~HRc45)		STD61 (HRc45~HRc55)		
	DIAMETER (mm)	RPM (mm ⁻¹)	FEED (mm/rev)	RPM (mm ⁻¹)	FEED (mm/rev)	RPM (mm ⁻¹)	FEED (mm/rev)
	20	1600	230	950	133	560	66
	25	1300	205	750	109	450	54
	30	1100	180	650	96	370	48
	40	800	145	500	85	280	36
	50	650	135	400	72	220	30





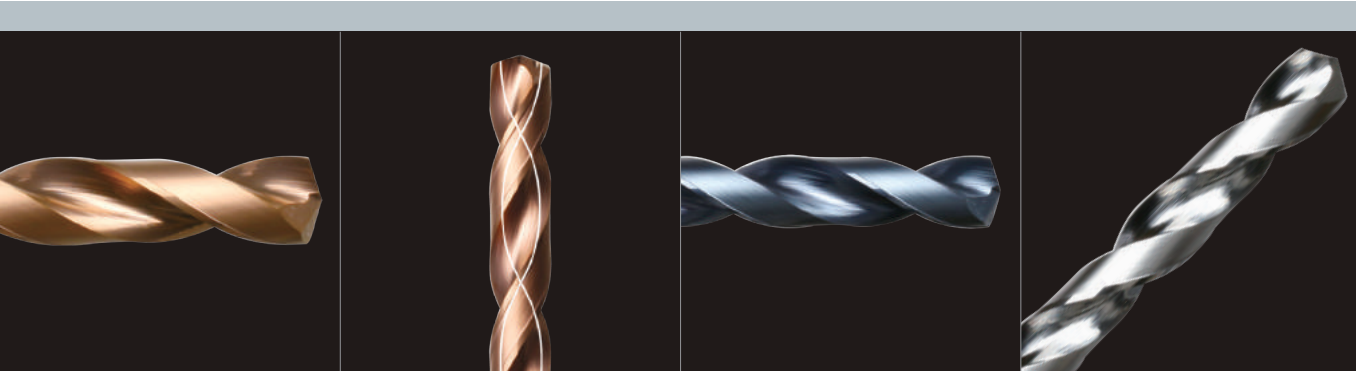











DRILL series





}	Power Max Drill Series Steel, Cast Iron, Stainless Steel	301
	Power Drill Series Steel, Cast Iron	347
	Solid Spiral Drill Series Multi-purpose	355
	Technical Data	358

DRILLS SERIES METRIC SIZE

Class	Feature	Type	Appearance	No. of Teeth	Item	App.	EDP. No.	Page				
POWER MAX DRILL	High Speed & General Speed Cutting			2FLUTE	3 X D		PF503	301				
				2FLUTE	5 X D		PF505	305				
				2FLUTE	3 X D / INTERNAL COOLANT		SF503	309				
				2FLUTE	5 X D / INTERNAL COOLANT		SF505	313				
						2FLUTE	10 X D / INTERNAL COOLANT		SF510	317		
						2FLUTE	20 X D / INTERNAL COOLANT		SF520	319		
								2FLUTE	HIGH PRECISION 3 X D		HP503	320
								2FLUTE	HIGH PRECISION 3 X D INTERNAL COOLANT		HPI 503	324
								2FLUTE	HIGH PRECISION 5 X D INTERNAL COOLANT		HPI 505	327
								2FLUTE	HIGH PRECISION 8 X D INTERNAL COOLANT		HPI 508	332
								2FLUTE	STUB / DIN 6537K		P503A(F)	335
								2FLUTE	STUB INTERNAL COOLANT/ DIN 6537K		PI503A(F)	339
								2FLUTE	MEDIUM INTERNAL COOLANT/ DIN 6537L		PI505A(F)	343
POWER DRILL	General Speed Cutting			2FLUTE	STUB TYPE - 3 X D		PDS	347				
				2FLUTE	MEDIUM TYPE - 5 X D		PDM	349				
						2FLUTE	STUB TYPE - 3 X D		PDSI	351		
						2FLUTE	MEDIUM TYPE - 5 X D		PDMI	353		
						2FLUTE	REGULAR LENGTH		SSD	355		
SS DRILL	General Purpose			2FLUTE	LONG LENGTH		SSDL	357				

	Carbon Steels (S45C,S55C...) ~ HB225	Alloy Steels (SCM,SK...) HB225~325	Prehardened Steels(NAK...) HRC30~50	Hardened Steels		Copper	Graphite	Cast Iron FCD400, 500~	Aluminum	Stainless Steels
				~HRc55 SKD61	HRC55~ SKD11					
	○	◎	◎	◎	○			◎		◎
	◎	◎	○	○				○		
	○								◎	

Standard Drill Series

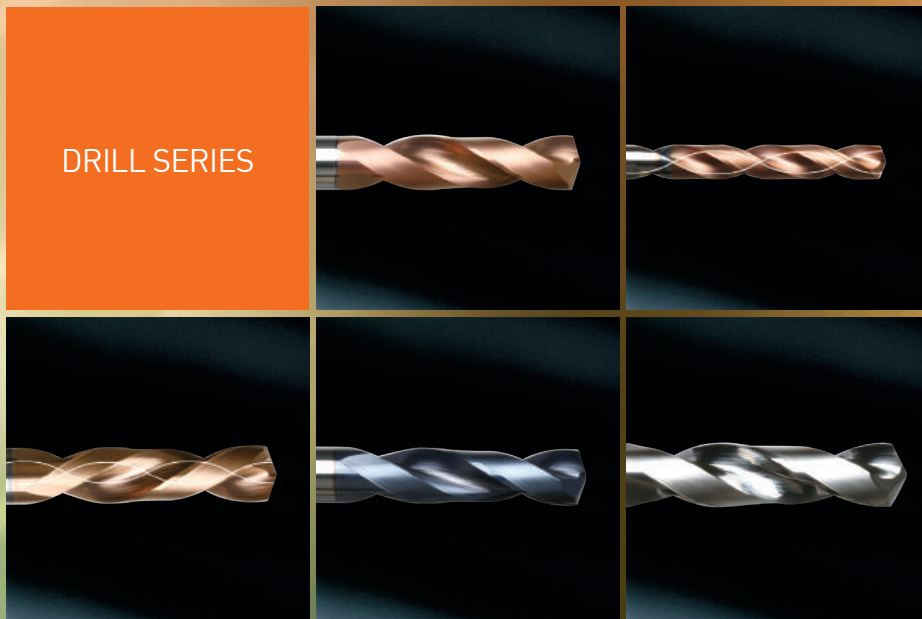



Power Max Drill Series



EDP. No.	APPEARANCE	FEATURE	STOCK	PAGE
PF503 ...series		3 X D	•	301
PF505 ...series		5 X D	•	305
SF503 ...series		3 X D / INTERNAL COOLANT	•	309
SF505 ...series		5 X D / INTERNAL COOLANT	•	313
SF510 ...series		10 X D / INTERNAL COOLANT	•	317
SF520 ...series		20 X D / INTERNAL COOLANT	•	319
HP503 ...series		HIGH PRECISION 3 X D	•	320
HPI 503 ...series		HIGH PRECISION 3 X D INTERNAL COOLANT	•	324
HPI 505 ...series		HIGH PRECISION 5 X D INTERNAL COOLANT	•	327
HPI 508 ...series		HIGH PRECISION 8 X D INTERNAL COOLANT	•	332
P503A(F) ...series		STUB / DIN 6537K		335
PI503A(F) ...series		STUB INTERNAL COOLANT/ DIN 6537K		339
PI505A(F) ...series		MEDIUM INTERNAL COOLANT/ DIN 6537L		343



Power Drill Series

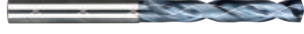

EDP. No.	APPEARANCE	FEATURE	STOCK	PAGE
PDS ...series		3 x D, POWER DRILL - STUB	•	347
PDM ...series		5 x D, POWER DRILL - MEDIUM	•	349
PDSI ...series		3 x D / POWER DRILL - STUB / INTERNAL COOLANT	•	351
PDMI ...series		5 x D / POWER DRILL - MEDIUM / INTERNAL COOLANT	•	353

Solid Spiral Drill Series



EDP. No.	APPEARANCE	FEATURE	STOCK	PAGE
SSD ...series		SOLID DRILL	•	355
SSDL ...series		SOLID DRILL - LONG	•	357

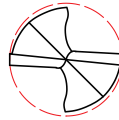
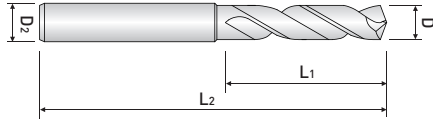

**3 X D / POWER MAX DRILL
STUB / HIGH SPEED MACHINING**

- Suitable for high speed cutting with newly developed raw-material and new coating.

PF503 ...series



EDP. No.	Dia.			L ₁	L ₂	D ₂	STOCK			
	mm	fraction	inch							
PF503020	2.0	-	.0796	14	50	3	•			
PF503021	2.1	-	.0835				•			
PF503022	2.2	-	.0875				•			
PF503023	2.3	-	.0915				•			
PF503024	2.4	-	.0955				•			
PF503025	2.5	-	.0994				•			
PF503026	2.6	-	.1034				•			
PF503027	2.7	-	.1074				•			
PF503028	2.8	-	.1114				•			
PF503029	2.9	-	.1154				•			
PF503030	3.0	-	.1193	18	60	•				
PF503031	3.1	-	.1233				•			
PF50303175	3.175	1/8	.1250	20	60	4	•			
PF503032	3.2	-	.1260				•			
PF50303264	3.264	#30	.1285				•			
PF503033	3.3	-	.1299				•			
PF503034	3.4	-	.1339				•			
PF503035	3.5	-	.1378				•			
PF50303572	3.572	9/64	.1406				22	60	4	•
PF503036	3.6	-	.1417							•
PF503037	3.7	-	.1457							•
PF503038	3.8	-	.1496							•
PF503039	3.9	-	.1535	•						
PF503040	4.0	-	.1575	24	60	5				•
PF50304039	4.039	#21	.1590							•
PF503041	4.1	-	.1614							•
PF503042	4.2	-	.1654							•
PF503043	4.3	-	.1693							•
PF503044	4.4	-	.1732				•			
PF503045	4.5	-	.1772				•			
PF503046	4.6	-	.1811				•			
PF503047	4.7	-	.1850				26	62	5	•
PF50304763	4.763	3/16	.1875							•
PF503048	4.8	-	.1890	•						
PF503049	4.9	-	.1929	•						
PF503050	5.0	-	.1969	•						
PF503051	5.1	-	.2008	•						
PF50305159	5.159	13/64	.2031	28	66	6				•
PF503052	5.2	-	.2047							•
PF503053	5.3	-	.2087							•
PF503054	5.4	-	.2126							•
PF503055	5.5	-	.2165				•			

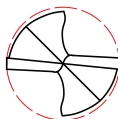
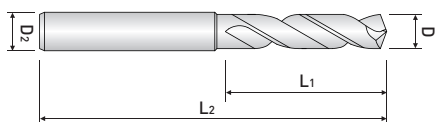

3 X D / POWER MAX DRILL STUB / HIGH SPEED MACHINING

- Suitable for high speed cutting with newly developed raw-material and new coating.

PF503 ...series



EDP. No.	Dia.			L ₁	L ₂	D ₂	STOCK			
	mm	fraction	inch							
PF50305558	5.558	7/32	.2188	30	66	6	•			
PF503056	5.6	-	.2205				•			
PF503057	5.7	-	.2244				•			
PF503058	5.8	-	.2283				•			
PF503059	5.9	-	.2323				•			
PF50305953	5.953	15/64	.2344				•			
PF503060	6.0	-	.2362				•			
PF503061	6.1	-	.2402				•			
PF503062	6.2	-	.2441				34	74	7	•
PF503063	6.3	-	.2480							•
PF5030635	6.350	1/4	.2500	•						
PF503064	6.4	-	.2520	•						
PF503065	6.5	-	.2559	•						
PF503066	6.6	-	.2598	•						
PF503067	6.7	-	.2638	•						
PF50306747	6.747	17/64	.2656	•						
PF503068	6.8	-	.2677	37	79	8				•
PF503069	6.9	-	.2717							•
PF503070	7.0	-	.2756				•			
PF503071	7.1	-	.2795				•			
PF50307145	7.145	9/32	.2795				•			
PF503072	7.2	-	.2813				•			
PF503073	7.3	-	.2835				•			
PF503074	7.4	-	.2874				•			
PF503075	7.5	-	.2913				•			
PF50307541	7.541	19/64	.2953				40	84	9	•
PF503076	7.6	-	.2969	•						
PF503077	7.7	-	.2992	•						
PF503078	7.8	-	.3031	•						
PF503079	7.9	-	.3071	•						
PF50307938	7.938	5/16	.3110	•						
PF503080	8.0	-	.3125	•						
PF503081	8.1	-	.3150	•						
PF503082	8.2	-	.3189	43	88	9				•
PF503083	8.3	-	.3228							•
PF50308334	8.334	21/64	.3268				•			
PF503084	8.4	-	.3281				•			
PF503085	8.5	-	.3307				•			
PF503086	8.6	-	.3346				•			
PF503087	8.7	-	.3386				•			
PF50308733	8.733	-	.3425				•			
PF503088	8.8	-	.3438				•			

EDP. No.	Dia.			L ₁	L ₂	D ₂	STOCK			
	mm	fraction	inch							
PF503089	8.9	-	.3504	43	84	9	•			
PF503090	9.0	-	.3543				•			
PF503091	9.1	-	.3583				•			
PF50309129	9.129	23/64	.3594	47	89	10	•			
PF503092	9.2	-	.3622				•			
PF503093	9.3	-	.3661				•			
PF503094	9.4	-	.3701				•			
PF503095	9.5	-	.3740				•			
PF50309525	9.525	3/8	.3750				•			
PF503096	9.6	-	.3780				•			
PF503097	9.7	-	.3819				•			
PF503098	9.8	-	.3858				•			
PF503099	9.9	-	.3898				•			
PF50309921	9.921	25/64	.3906				•			
PF503100	10.0	-	.3937				•			
PF503101	10.1	-	.3976				•			
PF503102	10.2	-	.4016				51	95	11	•
PF503103	10.3	-	.4055							•
PF5031032	10.32	13/32	.4063	•						
PF503104	10.4	-	.4094	•						
PF503105	10.5	-	.4134	•						
PF503106	10.6	-	.4173	•						
PF503107	10.7	-	.4213	•						
PF50310716	10.716	27/64	.4219	•						
PF503108	10.8	-	.4252	•						
PF503109	10.9	-	.4291	•						
PF503110	11.0	-	.4331	•						
PF503111	11.1	-	.4370	•						
PF50311113	11.113	7/16	.4375	54	102	12				•
PF503112	11.2	-	.4409							•
PF503113	11.3	-	.4449							•
PF503114	11.4	-	.4488				•			
PF503115	11.5	-	.4528				•			
PF503116	11.6	-	.4567				•			
PF503117	11.7	-	.4606				•			
PF503118	11.8	-	.4646				•			
PF503119	11.9	15/32	.4685				•			
PF50311908	11.908	-	.4688				•			
PF503120	12.0	-	.4724				•			
PF503121	12.1	-	.4764				•			
PF503122	12.2	-	.4803				57	102	13	•
PF503123	12.3	-	.4843							•
PF50312304	12.304	31/64	.4844							•
PF503124	12.4	-	.4882	•						
PF503125	12.5	-	.4921	•						
PF503126	12.6	-	.4961	•						
PF503127	12.7	-	.5000	•						
PF503128	12.8	-	.5039	•						
PF503129	12.9	-	.5079	•						
PF503130	13.0	-	.5118	•						
PF50313096	13.096	33/64	.5156	•						
PF503131	13.1	-	.5157	•						
PF503132	13.2	-	.5197	60	107	14				•
PF503133	13.3	-	.5236							•

EDP. No.	Dia.			L ₁	L ₂	D ₂	STOCK			
	mm	fraction	inch							
PF503134	13.4	-	.2188	60	107	14	•			
PF50313494	13.494	17/32	.2205				•			
PF503135	13.5	-	.2244				•			
PF503136	13.6	-	.2283				•			
PF503137	13.7	-	.2323				•			
PF503138	13.8	-	.2344				•			
PF50313891	13.891	35/64	.2362				•			
PF503139	13.9	-	.2402				•			
PF503140	14.0	-					•			
PF503141	14.1	-					•			
PF503142	14.2	-	.2441	62	111	15	•			
PF50314288	14.288	9/16	.24				•			
PF503143	14.3	-	.80				•			
PF503144	14.4	-	.2500				•			
PF503145	14.5	-	.2520				•			
PF503146	14.6	-	.2559				•			
PF503147	14.7	-	.2598				•			
PF503148	14.8	-	.2638				•			
PF503149	14.9	-	.2656				•			
PF503150	15.0	-	.2677				•			
PF50315081	15.081	19/32	.2717	64	115	16	•			
PF503151	15.1	-	.2756				•			
PF503152	15.2	-	.2795				•			
PF503153	15.3	-	.2813				•			
PF503154	15.4	-	.2835				•			
PF503155	15.5	-	.2874				•			
PF503156	15.6	-	.2913				•			
PF503157	15.7	-	.2953				•			
PF503158	15.8	-	.2969				•			
PF50315875	15.875	5/8	.2992				•			
PF503160	16.0	-	.3031	66	119	17	•			
PF503161	16.1	-	.3071				•			
PF503163	16.3	-					•			
PF503165	16.5	-					•			
PF50316667	16.667	21/32	.3110				•			
PF503170	17.0	-	.3125				•			
PF503171	17.1	-	.3150				•			
PF503172	17.2	-					66	123	18	•
PF503173	17.3	-								•
PF50317463	17.463	11/16								•
PF503175	17.5	-		•						
PF503177	17.7	-		•						
PF503178	17.8	-		•						
PF503180	18.0	-		•						
PF503181	18.1	-		•						
PF503182	18.2	-	.3189	70	127	19				•
PF503185	18.5	-	.3228							•
PF503190	19.0	-	.3268				•			
PF503191	19.1	-	.3281				•			
PF503193	19.3	-	.3307	70	131	20	•			
PF503195	19.5	-	.3346				•			
PF503197	19.7	-	.3425				•			
PF503200	20.0	-	.3438				•			

■ Tolerance μm=1/1000mm

Tolerance \ Dia.	from 1 to 3	over 3 to 6	over 6 to 10	over 10 to 18	over 18 to 30
Cutting Edge(h8)	0 -14	0 -18	0 -22	0 -27	0 -33
Shank(h6)	0 -6	0 -8	0 -9	0 -11	0 -13

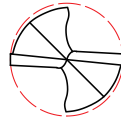
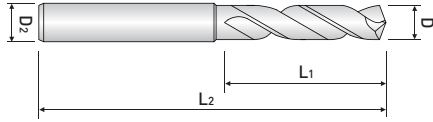

**5 X D / POWER MAX DRILL
MEDIUM / HIGH SPEED MACHINING**

- Suitable for high speed cutting with newly developed raw-material and new coating.

PF505 ...series



EDP. No.	Dia.			L ₁	L ₂	D ₂	STOCK		
	mm	fraction	inch						
PF505030	3.0	-	.1193	25	60	3	•		
PF505031	3.1	-	.1233	27		4	•		
PF50503175	3.175	1/8	.1250					30	
PF505032	3.2	-	.1260						33
PF50503264	3.264	#30	.1285						
PF505033	3.3	-	.1299	36	5			•	
PF505034	3.4	-	.1339			39			
PF505035	3.5	-	.1378	43					
PF50503572	3.572	9/64	.1406			47	6		•
PF505036	3.6	-	.1417	47					
PF505037	3.7	-	.1457		47				
PF505038	3.8	-	.1496	47					
PF505039	3.9	-	.1535		47				
PF50504039	4.039	#21	.1575	47					
PF505040	4.0	-	.1590		47				
PF505041	4.1	-	.1614	47					
PF505042	4.2	-	.1654		47				
PF505043	4.3	-	.1693	47					
PF505044	4.4	-	.1732		47				
PF505045	4.5	-	.1772	47					
PF505046	4.6	-	.1811		47				
PF505047	4.7	-	.1850	47					
PF50504763	4.763	3/16	.1875		47				
PF505048	4.8	-	.1890	47					
PF505049	4.9	-	.1929		47				
PF505050	5.0	-	.1969	47					
PF505051	5.1	-	.2008		47				
PF50505159	5.159	13/64	.2031	47					
PF505052	5.2	-	.2047		47				
PF505053	5.3	-	.2087	47					
PF505054	5.4	-	.2126		47				
PF505055	5.5	-	.2165	47					
PF50505558	5.558	7/32	.2188		47				
PF505056	5.6	-	.2205	47					
PF505057	5.7	-	.2244		47				
PF505058	5.8	-	.2283	47					
PF505059	5.9	-	.2323		47				
PF50505953	5.953	15/64	.2344	47					
PF505060	6.0	-	.2362		47				
PF505061	6.1	-	.2402	47					
PF505062	6.2	-	.2441		47				
PF505063	6.3	-	.2480	47					

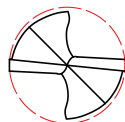
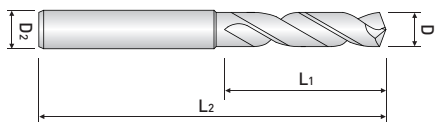

**5 X D / POWER MAX DRILL
MEDIUM / HIGH SPEED MACHINING**

- Suitable for high speed cutting with newly developed raw-material and new coating.

PF505 ...series



EDP. No.	Dia.			L1	L2	D2	STOCK
	mm	fraction	inch				
PF5050635	6.350	1/4	.2500	47	87	7	•
PF505064	6.4	-	.2520				•
PF505065	6.5	-	.2559				•
PF505066	6.6	-	.2598				•
PF505067	6.7	-	.2638				•
PF50506747	6.747	17/64	.2656				•
PF505068	6.8	-	.2677				•
PF505069	6.9	-	.2717				•
PF505070	7.0	-	.2756				•
PF505071	7.1	-	.2795				52
PF50507145	7.145	9/32	.2813	•			
PF505072	7.2	-	.2835	•			
PF505073	7.3	-	.2874	•			
PF505074	7.4	-	.2913	•			
PF505075	7.5	-	.2953	•			
PF50507541	7.541	19/64	.2969	•			
PF505076	7.6	-	.2992	•			
PF505077	7.7	-	.3031	•			
PF505078	7.8	-	.3071	•			
PF505079	7.9	-	.3110	•			
PF50507938	7.938	5/16	.3125	•			
PF505080	8.0	-	.3150	56	96	9	•
PF505081	8.1	-	.3189				•
PF505082	8.2	-	.3228				•
PF505083	8.3	-	.3268				•
PF50508334	8.334	21/64	.3281				•
PF505084	8.4	-	.3307				•
PF505085	8.5	-	.3346				•
PF505086	8.6	-	.3386				•
PF505087	8.7	-	.3325				•
PF50508733	8.733	11/32	.3338				•
PF505088	8.8	-	.3465	•			
PF505089	8.9	-	.3504	•			
PF505090	9.0	-	.3543	•			
PF505091	9.1	-	.3583	62	105	10	•
PF50509129	9.129	23/64	.3594				•
PF505092	9.2	-	.3622				•
PF505093	9.3	-	.3661				•
PF505094	9.4	-	.3701				•
PF505095	9.5	-	.3740				•
PF50509525	9.525	3/8	.3750				•
PF505096	9.6	-	.3780				•

EDP. No.	Dia.			L ₁	L ₂	D ₂	STOCK			
	mm	fraction	inch							
PF505097	9.7	-	.3819	62	105	10	•			
PF505098	9.8	-	.3858				•			
PF505099	9.9	-	.3898				•			
PF50509921	9.921	25/64	.3906				•			
PF505100	10.0	-	.3937				•			
PF505101	10.1	-	.3976	68	115	11	•			
PF505102	10.2	-	.4016				•			
PF505103	10.3	-	.4055				•			
PF50501032	10.32	13/32	.4063				•			
PF505104	10.4	-	.4094				•			
PF505105	10.5	-	.4134				•			
PF505106	10.6	-	.4173				•			
PF505107	10.7	-	.4213				•			
PF50510716	10.716	27/64	.4219				•			
PF505108	10.8	-	.4252				•			
PF505109	10.9	-	.4291				•			
PF505110	11.0	-	.4331				•			
PF505111	11.1	-	.4370				71	121	12	•
PF50511113	11.113	7/16	.4375							•
PF505112	11.2	-	.4409							•
PF505113	11.3	-	.4449	•						
PF505114	11.4	-	.4488	•						
PF505115	11.5	-	.4528	•						
PF505116	11.6	-	.4567	•						
PF505117	11.7	-	.4606	•						
PF505118	11.8	-	.4646	•						
PF505119	11.9	-	.4685	•						
PF50511908	11.908	15/32	.4688	•						
PF505120	12.0	-	.4724	•						
PF505121	12.1	-	.4764	75	125	13	•			
PF505122	12.2	-	.4803				•			
PF505123	12.3	-	.4843				•			
PF50512304	12.304	31/64	.4844				•			
PF505124	12.4	-	.4882				•			
PF505125	12.5	-	.4921				•			
PF505126	12.6	-	.4961				•			
PF505127	12.7	-	.5000				•			
PF505128	12.8	-	.5039				•			
PF505129	12.9	-	.5079				•			
PF505130	13.0	-	.5118				•			
PF50513096	13.096	33/64	.5156				80	134	14	•
PF505131	13.1	-	.5157							•
PF505132	13.2	-	.5197	•						
PF505133	13.3	-	.5236	•						
PF505134	13.4	-	.5276	•						
PF50513494	13.494	17/32	.5313	•						
PF505135	13.5	-	.5315	•						

EDP. No.	Dia.			L ₁	L ₂	D ₂	STOCK			
	mm	fraction	inch							
PF505136	13.6	-	.5354	80	134	14	•			
PF505137	13.7	-	.5394				•			
PF505138	13.8	-	.5433				•			
PF50513891	13.891	35/64	.5469				•			
PF505139	13.9	-	.5472				•			
PF505140	14.0	-	.5512				•			
PF505141	14.1	-	.5551				83	143	15	•
PF505142	14.2	-	.5591	•						
PF50514288	14.288	-	.5625	•						
PF505143	14.3	-	.5630	•						
PF505144	14.4	-	.5669	•						
PF505145	14.5	-	.5709	•						
PF505146	14.6	-	.5748	•						
PF505147	14.7	-	.5787	•						
PF505148	14.8	-	.5827	•						
PF505149	14.9	-	.5866	•						
PF505150	15.0	-	.5906	•						
PF50515081	15.081	19/32	.5937	90	152	16				•
PF505151	15.1	-	.5945							•
PF505152	15.2	-	.5984				•			
PF505154	15.4	-	.6063				•			
PF505155	15.5	-	.6102				•			
PF505156	15.6	-	.6142				•			
PF505157	15.7	-	.6181				•			
PF505158	15.8	-	.6220				•			
PF50515875	15.875	5/8	.6250				•			
PF505160	16.0	-	.6299				•			
PF505161	16.1	-	.6339				95	155	17	•
PF505163	16.3	-	.6417							•
PF505165	16.5	-	.6496							•
PF50516667	16.667	21/32	.6562	•						
PF505170	17.0	-	.6693	•						
PF505171	17.1	-	.6732	100	157	18	•			
PF505172	17.2	-	.6772				•			
PF50517463	17.463	11/16	.6875				•			
PF505175	17.5	-	.6890				•			
PF505177	17.7	-	.6969				•			
PF505178	17.8	-	.7008				•			
PF505180	18.0	-	.7087				•			
PF505181	18.1	-	.7126	105	160	19	•			
PF505182	18.2	-	.7165				•			
PF505185	18.5	-	.7283				•			
PF505190	19.0	-	.7480				•			
PF505191	19.1	-	.7520				110	163	20	•
PF505195	19.5	-	.7677	•						
PF505197	19.7	-	.7756	•						
PF505200	20.0	-	.7874	•						

■ Tolerance μm=1/1000mm

Tolerance \ Dia.	from 1 to 3	over 3 to 6	over 6 to 10	over 10 to 18	over 18 to 30
Cutting Edge(h8)	0 -14	0 -18	0 -22	0 -27	0 -33
Shank(h6)	0 -6	0 -8	0 -9	0 -11	0 -13

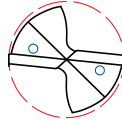
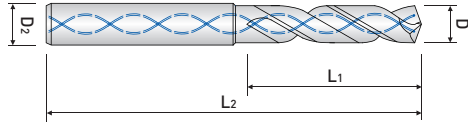

**3 X D / POWER MAX DRILL
STUB / INTERNAL COOLANT**

- Suitable for high speed cutting with newly developed raw-material and new coating.

SF503 ...series



EDP. No.	Dia.			L ₁	L ₂	D ₂	STOCK	
	mm	fraction	inch					
SF503030	3.0	-	.1193	18	60	3	•	
SF503031	3.1	-	.1233	20		4	•	
SF50303175	3.175	-	.1250				•	
SF503032	3.2	-	.1260				•	
SF50303246	3.264	-	.1285				•	
SF503033	3.3	-	.1299				•	
SF503034	3.4	-	.1339				•	
SF503035	3.5	-	.1378				•	
SF50303572	3.572	-	.1406				•	
SF503036	3.6	-	.1417				•	
SF503037	3.7	-	.1457	•				
SF503038	3.8	-	.1496	24	5	•		
SF503039	3.9	-	.1535			•		
SF503040	4.0	-	.1575			•		
SF50304039	4.039	-	.1590			26	6	•
SF503041	4.1	-	.1614					•
SF503042	4.2	-	.1654					•
SF503043	4.3	-	.1693					•
SF503044	4.4	-	.1732					•
SF503045	4.5	-	.1772					•
SF503046	4.6	-	.1811					•
SF503047	4.7	-	.1850	•				
SF50304763	4.763	-	.1875	•				
SF503048	4.8	-	.1890	•				
SF503049	4.9	-	.1929	28	7	•		
SF503050	5.0	-	.1969			•		
SF503051	5.1	-	.2008			•		
SF50305159	5.159	-	.2031			•		
SF503052	5.2	-	.2047			30	8	•
SF503053	5.3	-	.2087					•
SF503054	5.4	-	.2126					•
SF503055	5.5	-	.2165					•
SF50305558	5.558	-	.2188					•
SF503056	5.6	-	.2205					•
SF503057	5.7	-	.2244	•				
SF503058	5.8	-	.2283	•				
SF503059	5.9	-	.2323	•				
SF50305953	5.953	-	.2344	34	9			•
SF503060	6.0	-	.2362			•		
SF503061	6.1	-	.2402			•		
SF503062	6.2	-	.2441			•		
SF503063	6.3	-	.2480			•		

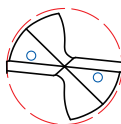
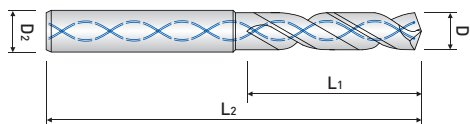

**3 X D / POWER MAX DRILL
STUB / INTERNAL COOLANT**

- Suitable for high speed cutting with newly developed raw-material and new coating.

SF503 ...series



EDP. No.	Dia.			L1	L2	D2	STOCK
	mm	fraction	inch				
SF5030635	6.350	-	.2500	34	74	7	•
SF503064	6.4	-	.2520				•
SF503065	6.5	-	.2559				•
SF503066	6.6	-	.2598				•
SF503067	6.7	-	.2638	37	74	7	•
SF50306747	6.747	-	.2656				•
SF503068	6.8	-	.2677				•
SF503069	6.9	-	.2717				•
SF503070	7.0	-	.2756	40	79	8	•
SF503071	7.1	-	.2795				•
SF50307145	7.145	-	.2813				•
SF503072	7.2	-	.2835				•
SF503073	7.3	-	.2874	43	84	9	•
SF503074	7.4	-	.2913				•
SF503075	7.5	-	.2953				•
SF50307541	7.541	-	.2969				•
SF503076	7.6	-	.2992	47	89	10	•
SF503077	7.7	-	.3031				•
SF503078	7.8	-	.3071				•
SF503079	7.9	-	.3110				•
SF50307938	7.938	-	.3125	43	84	9	•
SF503080	8.0	-	.3150				•
SF503081	8.1	-	.3189				•
SF503082	8.2	-	.3228				•
SF503083	8.3	-	.3268	47	89	10	•
SF50308334	8.334	-	.3281				•
SF503084	8.4	-	.3307				•
SF503085	8.5	-	.3346				•
SF503086	8.6	-	.3386	43	84	9	•
SF503087	8.7	-	.3325				•
SF50308733	8.733	-	.3338				•
SF503088	8.8	-	.3465				•
SF503089	8.9	-	.3504	47	89	10	•
SF503090	9.0	-	.3543				•
SF503091	9.1	-	.3583				•
SF50309129	9.129	-	.3594				•
SF503092	9.2	-	.3622	43	84	9	•
SF503093	9.3	-	.3661				•
SF503094	9.4	-	.3701				•
SF503095	9.5	-	.3740				•
SF50309525	9.525	-	.3750	47	89	10	•
SF503096	9.6	-	.3780				•

EDP. No.	Dia.			L ₁	L ₂	D ₂	STOCK			
	mm	fraction	inch							
SF503097	9.7	-	.3819	47	89	10	•			
SF503098	9.8	-	.3858				•			
SF503099	9.9	-	.3898				•			
SF50309921	9.921	25/64	.3906				•			
SF503100	10.0	-	.3937				•			
SF503101	10.1	-	.3976	51	95	11	•			
SF503102	10.2	-	.4016				•			
SF503103	10.3	-	.4055				•			
SF5031032	10.32	13/32	.4063				•			
SF503104	10.4	-	.4094				•			
SF503105	10.5	-	.4134				•			
SF503106	10.6	-	.4173				•			
SF503107	10.7	-	.4213				•			
SF50310716	10.716	27/64	.4219				•			
SF503108	10.8	-	.4252				•			
SF503109	10.9	-	.4291				•			
SF503110	11.0	-	.4331				•			
SF503111	11.1	-	.4370				54	102	12	•
SF50311113	11.113	7/16	.4375							•
SF503112	11.2	-	.4409							•
SF503113	11.3	-	.4449	•						
SF503114	11.4	-	.4488	•						
SF503115	11.5	-	.4528	•						
SF503116	11.6	-	.4567	•						
SF503117	11.7	-	.4606	•						
SF503118	11.8	-	.4646	•						
SF503119	11.9	-	.4685	•						
SF50311908	11.908	15/32	.4688	•						
SF503120	12.0	-	.4724	•						
SF503121	12.1	-	.4764	57	102	13				•
SF503122	12.2	-	.4803							•
SF503123	12.3	-	.4843							•
SF50312304	12.304	31/64	.4844				•			
SF503124	12.4	-	.4882				•			
SF503125	12.5	-	.4921				•			
SF503126	12.6	-	.4961				•			
SF503127	12.7	-	.5000				•			
SF503128	12.8	-	.5039				•			
SF503129	12.9	-	.5079				•			
SF503130	13.0	-	.5118				•			
SF50313096	13.096	33/64	.5156				60	107	14	•
SF503131	13.1	-	.5157							•
SF503132	13.2	-	.5197							•
SF503133	13.3	-	.5236							•
SF503134	13.4	-	.5276	•						
SF50313494	13.494	17/32	.5313	•						
SF503135	13.5	-	.5315	•						

EDP. No.	Dia.			L ₁	L ₂	D ₂	STOCK			
	mm	fraction	inch							
SF503136	13.6	-	.5354	60	107	14	•			
SF503137	13.7	-	.5394				•			
SF503138	13.8	-	.5433				•			
SF50313891	13.891	35/64	.5469				•			
SF503139	13.9	-	.5472				•			
SF503140	14.0	-	.5512				•			
SF503141	14.1	-	.5551				62	111	15	•
SF503142	14.2	-	.5591	•						
SF50314288	14.288	9/16	.5625	•						
SF503143	14.3	-	.5630	•						
SF503144	14.4	-	.5669	•						
SF503145	14.5	-	.5709	•						
SF503146	14.6	-	.5748	•						
SF503147	14.7	-	.5787	•						
SF503148	14.8	-	.5827	•						
SF503149	14.9	-	.5866	•						
SF503150	15.0	-	.5906	•						
SF50315081	15.081	19/32	.5937	64	115	16				•
SF503151	15.1	-	.5945							•
SF503152	15.2	-	.5984				•			
SF503154	15.4	-	.6063				•			
SF503155	15.5	-	.6102				•			
SF503156	15.6	-	.6142				•			
SF503157	15.7	-	.6181				•			
SF503158	15.8	-	.6220				•			
SF50315875	15.875	5/8	.6250				•			
SF503160	16.0	-	.6299				•			
SF503161	16.1	-	.6339				66	119	17	•
SF503163	16.3	-	.6417							•
SF503165	16.5	-	.6496							•
SF50316667	16.667	21/32	.6562	•						
SF503170	17.0	-	.6693	•						
SF503171	17.1	-	.6732	66	123	18	•			
SF503172	17.2	-	.6772				•			
SF50317463	17.463	11/16	.6875				•			
SF503175	17.5	-	.6890				•			
SF503177	17.7	-	.6969				•			
SF503178	17.8	-	.7008				•			
SF503180	18.0	-	.7087				•			
SF503181	18.1	-	.7126	70	127	19	•			
SF503182	18.2	-	.7165				•			
SF503185	18.5	-	.7283				•			
SF503190	19.0	-	.7480				•			
SF503191	19.1	-	.7520				70	131	20	•
SF503195	19.5	-	.7677	•						
SF503197	19.7	-	.7756	•						
SF503200	20.0	-	.7874	•						

■ Tolerance μm=1/1000mm

Tolerance \ Dia.	from 1 to 3	over 3 to 6	over 6 to 10	over 10 to 18	over 18 to 30
Cutting Edge(h8)	0 -14	0 -18	0 -22	0 -27	0 -33
Shank(h6)	0 -6	0 -8	0 -9	0 -11	0 -13

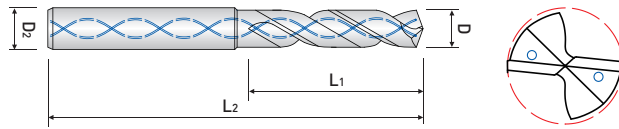

5 X D / POWER MAX DRILL
MEDIUM / INTERNAL COOLANT,

- Suitable for high speed cutting with newly developed raw-material and new coating.

SF505 ...series



EDP. No.	Dia.			L1	L2	D2	STOCK
	mm	fraction	inch				
SF505031	3.1	-	.1233	27	74	4	•
SF50503175	3.175	1/8	.1250				•
SF505032	3.2	-	.1260				•
SF50503264	3.264	#30	.1285				•
SF505033	3.3	-	.1299				•
SF505034	3.4	-	.1339				•
SF505035	3.5	-	.1378	30	74	4	•
SF50503572	3.572	9/64	.1406				•
SF505036	3.6	-	.1417				•
SF505037	3.7	-	.1457				•
SF505038	3.8	-	.1496				•
SF505039	3.9	-	.1535				•
SF505040	4.0	-	.1575	33	74	4	•
SF50504039	4.039	#21	.1590				•
SF505041	4.1	-	.1614				•
SF505042	4.2	-	.1654				•
SF505043	4.3	-	.1693				•
SF505044	4.4	-	.1732				36
SF505045	4.5	-	.1772	•			
SF505046	4.6	-	.1811	•			
SF505047	4.7	-	.1850	•			
SF50504763	4.763	3/16	.1875	•			
SF505048	4.8	-	.1890	39	80	5	
SF505049	4.9	-	.1929				•
SF505050	5.0	-	.1969				•
SF505051	5.1	-	.2008				•
SF50505159	5.159	13/64	.2031				•
SF505052	5.2	-	.2047				43
SF505053	5.3	-	.2087	•			
SF505054	5.4	-	.2126	•			
SF505055	5.5	-	.2165	•			
SF50505558	5.558	7/32	.2188	•			
SF505056	5.6	-	.2205	47	95	7	
SF505057	5.7	-	.2244				•
SF505058	5.8	-	.2283				•
SF505059	5.9	-	.2323				•
SF50505953	5.953	15/64	.2344				•
SF505060	6.0	-	.2362				47
SF505061	6.1	-	.2402	•			
SF505062	6.2	-	.2441	•			
SF505063	6.3	-	.2480	•			
SF5050635	6.350	1/4	.2500	•			

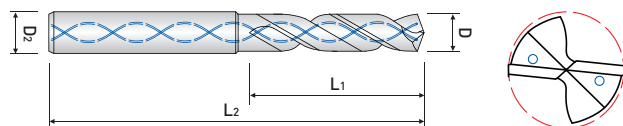

5 X D / POWER MAX DRILL
MEDIUM / INTERNAL COOLANT,

- Suitable for high speed cutting with newly developed raw-material and new coating.

SF505 ...series



EDP. No.	Dia.			L ₁	L ₂	D ₂	STOCK			
	mm	fraction	inch							
SF505064	6.4	-	.2520	47	95	7	•			
SF505065	6.5	-	.2559				•			
SF505066	6.6	-	.2598				•			
SF505067	6.7	-	.2638				•			
SF50506747	6.747	17/64	.2656				•			
SF505068	6.8	-	.2677				•			
SF505069	6.9	-	.2717				•			
SF505070	7.0	-	.2756				•			
SF505071	7.1	-	.2795				52	103	8	•
SF50507145	7.145	9/32	.2813							•
SF505072	7.2	-	.2835	•						
SF505073	7.3	-	.2874	•						
SF505074	7.4	-	.2913	•						
SF505075	7.5	-	.2953	•						
SF50507541	7.541	19/64	.2969	•						
SF505076	7.6	-	.2992	•						
SF505077	7.7	-	.3031	•						
SF505078	7.8	-	.3071	•						
SF505079	7.9	-	.3110	•						
SF50507938	7.938	5/16	.3125	•						
SF505080	8.0	-	.3150	•						
SF505081	8.1	-	.3189	56	105	9	•			
SF505082	8.2	-	.3228				•			
SF505083	8.3	-	.3268				•			
SF50508334	8.334	21/64	.3281				•			
SF505084	8.4	-	.3307				•			
SF505085	8.5	-	.3346				•			
SF505086	8.6	-	.3386				•			
SF505087	8.7	-	.3325				•			
SF50508733	8.733	11/32	.3338				•			
SF505088	8.8	-	.3465				•			
SF505089	8.9	-	.3504	•						
SF505090	9.0	-	.3543	•						
SF505091	9.1	-	.3583	62	108	10	•			
SF50509129	9.129	23/64	.3594				•			
SF505092	9.2	-	.3622				•			
SF505093	9.3	-	.3661				•			
SF505094	9.4	-	.3701				•			
SF505095	9.5	-	.3740				•			
SF50509525	9.525	3/8	.3750				•			
SF505096	9.6	-	.3780				•			
SF505097	9.7	-	.3819				•			

EDP. No.	Dia.			L ₁	L ₂	D ₂	STOCK			
	mm	fraction	inch							
SF505098	9.8	-	.3858	62	108	10	•			
SF505099	9.9	-	.3898				•			
SF50509921	9.921	25/64	.3906				•			
SF505100	10.0	-	.3937				•			
SF505101	10.1	-	.3976	68	125	11	•			
SF505102	10.2	-	.4016				•			
SF505103	10.3	-	.4055				•			
SF5051032	10.32	13/32	.4063				•			
SF505104	10.4	-	.4094				•			
SF505105	10.5	-	.4134				•			
SF505106	10.6	-	.4173				•			
SF505107	10.7	-	.4213				•			
SF50510716	10.716	27/64	.4219				•			
SF505108	10.8	-	.4252				•			
SF505109	10.9	-	.4291				•			
SF505110	11.0	-	.4331				•			
SF505111	11.1	-	.4370				71	133	12	•
SF50511113	11.113	7/16	.4375							•
SF505112	11.2	-	.4409	•						
SF505113	11.3	-	.4449	•						
SF505114	11.4	-	.4488	•						
SF505115	11.5	-	.4528	•						
SF505116	11.6	-	.4567	•						
SF505117	11.7	-	.4606	•						
SF505118	11.8	-	.4646	•						
SF505119	11.9	-	.4685	•						
SF50511908	11.908	15/32	.4688	•						
SF505120	12.0	-	.4724	•						
SF505121	12.1	-	.4764	75	137	13				•
SF505122	12.2	-	.4803							•
SF505123	12.3	-	.4843				•			
SF50512304	12.304	31/64	.4844				•			
SF505124	12.4	-	.4882				•			
SF505125	12.5	-	.4921				•			
SF505126	12.6	-	.4961				•			
SF505127	12.7	-	.5000				•			
SF505128	12.8	-	.5039				•			
SF505129	12.9	-	.5079				•			
SF505130	13.0	-	.5118				•			
SF50513096	13.096	33/64	.5156				80	142	14	•
SF505131	13.1	-	.5157							•
SF505132	13.2	-	.5197							•
SF505133	13.3	-	.5236	•						
SF505134	13.4	-	.5276	•						
SF50513494	13.494	-	.5313	•						
SF505135	13.5	17/32	.5315	•						
SF505136	13.6	-	.5354	•						

EDP. No.	Dia.			L ₁	L ₂	D ₂	STOCK			
	mm	fraction	inch							
SF505137	13.7	-	.5354	80	142	14	•			
SF505138	13.8	-	.5394				•			
SF50513891	13.891	35/64	.5469				•			
SF505139	13.9	-	.5472				•			
SF505140	14.0	-	.5512				•			
SF505141	14.1	-	.5551	83	148	15	•			
SF505142	14.2	-	.5591				•			
SF50514288	14.288	9/16	.5625				•			
SF505143	14.3	-	.5630				•			
SF505144	14.4	-	.5669				•			
SF505145	14.5	-	.5709				•			
SF505146	14.6	-	.5748				•			
SF505147	14.7	-	.5787				•			
SF505148	14.8	-	.5827				•			
SF505149	14.9	-	.5866				•			
SF505150	15.0	-	.5906				•			
SF50515081	15.081	19/32	.5937				90	152	16	•
SF505151	15.1	-	.5945							•
SF505152	15.2	-	.5984	•						
SF505154	15.4	-	.6063	•						
SF505155	15.5	-	.6102	•						
SF505156	15.6	-	.6142	•						
SF505157	15.7	-	.6181	•						
SF505158	15.8	-	.6220	•						
SF50515875	15.875	5/8	.6250	•						
SF505160	16.0	-	.6299	•						
SF505161	16.1	-	.6339	95	155	17				•
SF505163	16.3	-	.6417							•
SF505165	16.5	-	.6496							•
SF50516667	16.667	21/32	.6562				•			
SF505170	17.0	-	.6693				•			
SF505171	17.1	-	.6732	100	157	18	•			
SF505172	17.2	-	.6772				•			
SF50517463	17.463	11/16	.6875				•			
SF505175	17.5	-	.6890				•			
SF505177	17.7	-	.6969				•			
SF505178	17.8	-	.7008				•			
SF505180	18.0	-	.7087				•			
SF505181	18.1	-	.7126				105	160	19	•
SF505182	18.2	-	.7165	•						
SF505185	18.5	-	.7283	•						
SF505190	19.0	-	.7480	•						
SF505191	19.1	-	.7520	110	163	20	•			
SF505195	19.5	-	.7677				•			
SF505197	19.7	-	.7756				•			
SF505200	20.0	-	.7874				•			

■ Tolerance μm=1/1000mm

Tolerance \ Dia.	from 1 to 3	over 3 to 6	over 6 to 10	over 10 to 18	over 18 to 30
Cutting Edge(h8)	0 -14	0 -18	0 -22	0 -27	0 -33
Shank(h6)	0 -6	0 -8	0 -9	0 -11	0 -13

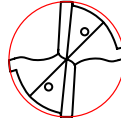
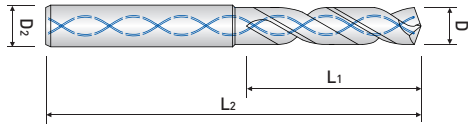

10 X D / POWER MAX DRILL
- LONG / INTERNAL COOLANT

SF510 ...series



EDP. No.	Dia.	L ₁	L ₂	D ₂	STOCK
SF510 030	3.0	39	87	3	•
SF510 031	3.1	46	94	4	•
SF510 032	3.2				•
SF510 033	3.3				•
SF510 034	3.4				•
SF510 035	3.5	52	101		•
SF510 036	3.6				•
SF510 037	3.7				•
SF510 038	3.8				•
SF510 039	3.9				•
SF510 040	4.0				•
SF510 041	4.1	59	108	5	•
SF510 042	4.2				•
SF510 043	4.3				•
SF510 044	4.4				•
SF510 045	4.5	66	117		•
SF510 046	4.6				•
SF510 047	4.7				•
SF510 048	4.8				•
SF510 049	4.9				•
SF510 050	5.0				•
SF510 051	5.1	72	123	6	•
SF510 052	5.2				•
SF510 053	5.3				•
SF510 054	5.4				•
SF510 055	5.5	79	130		•
SF510 056	5.6				•
SF510 057	5.7				•
SF510 058	5.8				•
SF510 059	5.9				•
SF510 060	6.0				•
SF510 061	6.1	85	138	7	•
SF510 062	6.2				•
SF510 063	6.3				•
SF510 064	6.4				•
SF510 065	6.5				•
SF510 066	6.6				•

EDP. No.	Dia.	L ₁	L ₂	D ₂	STOCK	
SF510 067	6.7	92	145	7	•	
SF510 068	6.8				•	
SF510 069	6.9				•	
SF510 070	7.0				•	
SF510 071	7.1	98	153		8	•
SF510 072	7.2					•
SF510 073	7.3					•
SF510 074	7.4					•
SF510 075	7.5					•
SF510 076	7.6					105
SF510 077	7.7	•				
SF510 078	7.8	•				
SF510 079	7.9	•				
SF510 080	8.0	111	166	9		•
SF510 081	8.1				•	
SF510 082	8.2				•	
SF510 083	8.3				•	
SF510 084	8.4				•	
SF510 085	8.5				118	173
SF510 086	8.6	•				
SF510 087	8.7	•				
SF510 088	8.8	•				
SF510 089	8.9	124	179		10	•
SF510 090	9.0			•		
SF510 091	9.1			•		
SF510 092	9.2			•		
SF510 093	9.3			•		
SF510 094	9.4			131		186
SF510 095	9.5	•				
SF510 096	9.6	•				
SF510 097	9.7	•				
SF510 098	9.8	138	193	11		•
SF510 099	9.9				•	
SF510 100	10.0				•	
SF510 101	10.1				•	
SF510 102	10.2				•	
SF510 103	10.3				•	

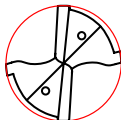
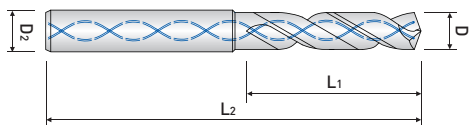

10 X D / POWER MAX DRILL
- LONG / INTERNAL COOLANT

SF510 ...series



EDP. No.	Dia.	L ₁	L ₂	D ₂	STOCK
SF510 104	10.4	138	193	11	•
SF510 105	10.5				•
SF510 106	10.6	•			
SF510 107	10.7	•			
SF510 108	10.8	144	205		•
SF510 109	10.9				•
SF510 110	11.0	•			
SF510 111	11.1	151	212	12	•
SF510 112	11.2				•
SF510 113	11.3				•
SF510 114	11.4				•
SF510 115	11.5				•

EDP. No.	Dia.	L ₁	L ₂	D ₂	STOCK
SF510 116	11.6	157	218	12	•
SF510 117	11.7				•
SF510 118	11.8				•
SF510 119	11.9				•
SF510 120	12.0	•			
SF510 121	12.1	164	225	13	•
SF510 122	12.2				•
SF510 123	12.3				•
SF510 124	12.4				•
SF510 125	12.5	170	236		•
SF510 126	12.6				•
SF510 127	12.7			•	
SF510 128	12.8			•	
SF510 129	12.9			•	
SF510 130	13.0			•	

■ Tolerance μm = 1/1000mm

Tolerance \ Dia.	from 1 to 3	over 3 to 6	over 6 to 10	over 10 to 18	over 18 to 30
Cutting Edge(h8)	0 -14	0 -18	0 -22	0 -27	0 -33
Shank(h6)	0 -6	0 -8	0 -9	0 -11	0 -13

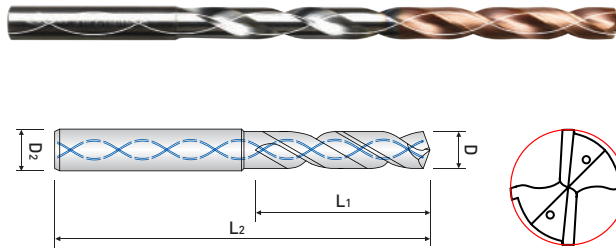

20 X D / POWER MAX DRILL
- EXTRA LONG / INTERNAL COOLANT

SF520 ...series



EDP. No.	Dia.	L1	L2	D2	STOCK
SF520 041	4.1	104	155	5	•
SF520 042	4.2				•
SF520 043	4.3				•
SF520 044	4.4				•
SF520 045	4.5				•
SF520 046	4.6	116	167	5	•
SF520 047	4.7				•
SF520 048	4.8				•
SF520 049	4.9				•
SF520 050	5.0				•
SF520 051	5.1	127	178	6	•
SF520 052	5.2				•
SF520 053	5.3				•
SF520 054	5.4				•
SF520 055	5.5				•
SF520 056	5.6	139	190	6	•
SF520 057	5.7				•
SF520 058	5.8				•
SF520 059	5.9				•
SF520 060	6.0				•
SF520 061	6.1	150	203	7	•
SF520 062	6.2				•
SF520 063	6.3				•
SF520 064	6.4				•
SF520 065	6.5				•
SF520 066	6.6	162	215	7	•
SF520 067	6.7				•
SF520 068	6.8				•
SF520 069	6.9				•
SF520 070	7.0				•

EDP. No.	Dia.	L1	L2	D2	STOCK
SF520 071	7.1	173	228	8	•
SF520 072	7.2				•
SF520 073	7.3				•
SF520 074	7.4				•
SF520 075	7.5				•
SF520 076	7.6	185	240	8	•
SF520 077	7.7				•
SF520 078	7.8				•
SF520 079	7.9				•
SF520 080	8.0				•
SF520 081	8.1	196	251	9	•
SF520 082	8.2				•
SF520 083	8.3				•
SF520 084	8.4				•
SF520 085	8.5				•
SF520 086	8.6	208	263	9	•
SF520 087	8.7				•
SF520 088	8.8				•
SF520 089	8.9				•
SF520 090	9.0				•
SF520 091	9.1	219	274	10	•
SF520 092	9.2				•
SF520 093	9.3				•
SF520 094	9.4				•
SF520 095	9.5				•
SF520 096	9.6	231	286	10	•
SF520 097	9.7				•
SF520 098	9.8				•
SF520 099	9.9				•
SF520 100	10.0				•

■ Tolerance mm = 1/1000mm

Tolerance \ Dia.	from 1 to 3	over 3 to 6	over 6 to 10	over 10 to 18	over 18 to 30
Cutting Edge(h8)	0 -14	0 -18	0 -22	0 -27	0 -33
Shank(h6)	0 -6	0 -8	0 -9	0 -11	0 -13

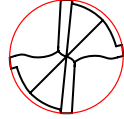
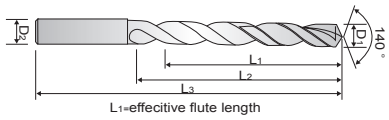

POWER MAX DRILL-HIGH PRECISION

- Applied highly precise hole tolerance on the tool .
- Increased tool life by minimizing chatter and resonance on the (through hole) penetrated hole or (blind hole) one-side open hole area.

HP503 ...series



EDP. No.	D ₁ (mm)	D ₂ (h6)	L ₁	L ₂	L ₃	STOCK
HP503030	3.0	6	14	20	62	•
HP503031	3.1					•
HP503032	3.2					•
HP503033	3.3					•
HP503034	3.4					•
HP503035	3.5					•
HP503036	3.6					•
HP503037	3.7					•
HP503038	3.8	6	17	24	66	•
HP503039	3.9					•
HP503040	4.0					•
HP503041	4.1					•
HP503042	4.2					•
HP503043	4.3					•
HP503044	4.4					•
HP503045	4.5					•
HP503046	4.6					•
HP503047	4.7					•
HP503048	4.8	6	20	28	66	•
HP503049	4.9					•
HP503050	5.0					•
HP503051	5.1					•
HP503052	5.2					•
HP503053	5.3					•
HP503054	5.4					•
HP503055	5.5					•
HP503056	5.6					•
HP503057	5.7					•
HP503058	5.8					•
HP503059	5.9					•
HP503060	6.0					•

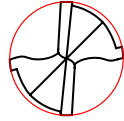
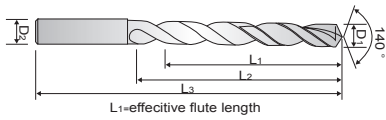

POWER MAX DRILL-HIGH PRECISION

- Applied highly precise hole tolerance on the tool .
- Increased tool life by minimizing chatter and resonance on the (through hole) penetrated hole or (blind hole) one-side open hole area.

HP503 ...series



EDP. No.	D ₁ (mm)	D ₂ (h6)	L ₁	L ₂	L ₃	STOCK
HP503061	6.1	8	24	34	79	•
HP503062	6.2					•
HP503063	6.3					•
HP503064	6.4					•
HP503065	6.5					•
HP503066	6.6					•
HP503067	6.7					•
HP503068	6.8					•
HP503069	6.9					•
HP503070	7.0					•
HP503071	7.1	8	29	41	79	•
HP503072	7.2					•
HP503073	7.3					•
HP503074	7.4					•
HP503075	7.5					•
HP503076	7.6					•
HP503077	7.7					•
HP503078	7.8					•
HP503079	7.9					•
HP503080	8.0					•
HP503081	8.1	10	35	47	89	•
HP503082	8.2					•
HP503083	8.3					•
HP503084	8.4					•
HP503085	8.5					•
HP503086	8.6					•
HP503087	8.7					•
HP503088	8.8					•
HP503089	8.9					•
HP503090	9.0					•
HP503091	9.1					•

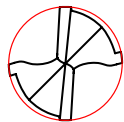
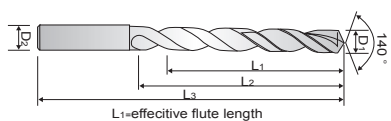

POWER MAX DRILL-HIGH PRECISION

- Applied highly precise hole tolerance on the tool .
- Increased tool life by minimizing chatter and resonance on the (through hole) penetrated hole or (blind hole) one-side open hole area.

HP503 ...series



EDP. No.	D ₁ (mm)	D ₂ (h6)	L ₁	L ₂	L ₃	STOCK
HP503092	9.2	10	35	47	89	•
HP503093	9.3					•
HP503094	9.4					•
HP503095	9.5					•
HP503096	9.6					•
HP503097	9.7					•
HP503098	9.8					•
HP503099	9.9					•
HP503100	10.0					•
HP503101	10.1					12
HP503102	10.2	•				
HP503103	10.3	•				
HP503104	10.4	•				
HP503105	10.5	•				
HP503106	10.6	•				
HP503107	10.7	•				
HP503108	10.8	•				
HP503109	10.9	•				
HP503110	11.0	•				
HP503111	11.1	•				
HP503112	11.2	•				
HP503113	11.3	•				
HP503114	11.4	•				
HP503115	11.5	•				
HP503116	11.6	•				
HP503117	11.7	•				
HP503118	11.8	•				
HP503119	11.9	•				
HP503120	12.0	•				

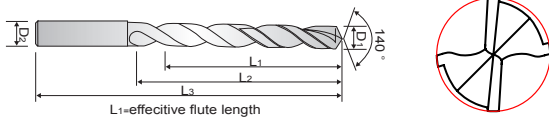

POWER MAX DRILL-HIGH PRECISION

- Applied highly precise hole tolerance on the tool .
- Increased tool life by minimizing chatter and resonance on the (through hole) penetrated hole or (blind hole) one-side open hole area.

HP503 ...series



EDP. No.	D ₁ (mm)	D ₂ (h6)	L ₁	L ₂	L ₃	STOCK
HP503121	12.1	14	43	60	107	•
HP503122	12.2					•
HP503123	12.3					•
HP503124	12.4					•
HP503125	12.5					•
HP503126	12.6					•
HP503127	12.7					•
HP503128	12.8					•
HP503129	12.9					•
HP503130	13.0					•
HP503131	13.1					•
HP503132	13.2					•
HP503133	13.3					•
HP503135	13.5					•
HP503137	13.7	•				
HP503140	14.0	•				
HP503142	14.2	16	45	65	115	•
HP503143	14.3					•
HP503145	14.5					•
HP503146	14.6					•
HP503148	14.8					•
HP503150	15.0					•
HP503155	15.5					•
HP503157	15.7					•
HP503160	16.0					•

■ Tolerance μm = 1/1000mm

Tolerance \ Dia.	from 1 to 3	over 3 to 6	over 6 to 10	over 10 to 18	over 18 to 30
Cutting Edge(m7)	+12 +2	+16 +4	+21 +6	+25 +7	+29 +8
Shank(h6)	0 -6	0 -8	0 -9	0 -11	0 -13

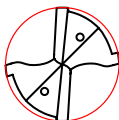
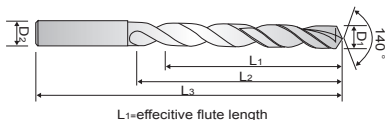

3 X D / POWER MAX DRILL-HIGH PRECISION

- Applied highly precise hole tolerance on the tool.
- Increased tool life by minimizing chatter and resonance on the (through hole) penetrated hole or (blind hole) one-side open hole area.

HPI 503 ...series



EDP. No.	D ₁	D ₂	L ₁	L ₂	L ₃	STOCK				
	mm									
HPI 50303175	3.175	6	14	20	62	•				
HPI 50303264	3.264					•				
HPI 50303572	3.572					•				
HPI 5030397	3.97	6	17	24	66	•				
HPI 503040	4					•				
HPI 50304039	4.039					•				
HPI 503042	4.2					•				
HPI 503043	4.3					•				
HPI 503045	4.5					•				
HPI 503046	4.6					•				
HPI 50304763	4.763					6	20	28	66	•
HPI 503048	4.8	•								
HPI 503049	4.9	•								
HPI 503050	5	•								
HPI 503051	5.1	•								
HPI 50305159	5.159	•								
HPI 503052	5.2	•								
HPI 503053	5.3	•								
HPI 503054	5.4	•								
HPI 503055	5.5	•								
HPI 50305558	5.558	•								
HPI 503056	5.6	•								
HPI 503057	5.7	•								
HPI 503058	5.8	•								
HPI 50305953	5.953	•								
HPI 503060	6	•								
HPI 503062	6.2	8	24	34	79					•
HPI 5030635	6.35									•
HPI 503065	6.5									•
HPI 503066	6.6									•
HPI 50306747	6.747					•				
HPI 503068	6.8					•				
HPI 503070	7					•				
HPI 50307145	7.145	8	29	41	79	•				
HPI 503072	7.2					•				
HPI 503074	7.4					•				
HPI 503075	7.5					•				
HPI 50307541	7.541					•				

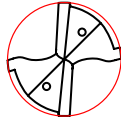
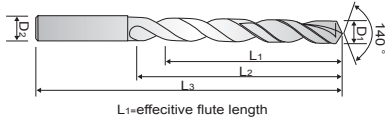

3 X D / POWER MAX DRILL-HIGH PRECISION

- Applied highly precise hole tolerance on the tool.
- Increased tool life by minimizing chatter and resonance on the (through hole) penetrated hole or (blind hole) one-side open hole area.

HPI 503 ...series



EDP. No.	D ₁	D ₂	L ₁	L ₂	L ₃	STOCK
	mm					
HPI 503078	7.8	8	29	41	79	•
HPI 503079	7.9					•
HPI 50307938	7.938					•
HPI 503080	8					•
HPI 503081	8.1	10	35	47	89	•
HPI 503082	8.2					•
HPI 503083	8.3					•
HPI 50308334	8.334					•
HPI 503085	8.5					•
HPI 503086	8.6					•
HPI 503087	8.7					•
HPI 50308733	8.733					•
HPI 503088	8.8					•
HPI 503090	9					•
HPI 503091	9.1					•
HPI 50309129	9.129					•
HPI 503092	9.2					•
HPI 503093	9.3					•
HPI 503095	9.5					•
HPI 50309525	9.525					•
HPI 503096	9.6	•				
HPI 503097	9.7	•				
HPI 503098	9.8	•				
HPI 50309921	9.921	•				
HPI 503100	10	•				
HPI 503102	10.2	12	40	55	105	•
HPI 5031032	10.32					•
HPI 503105	10.5					•
HPI 503107	10.7					•
HPI 50310716	10.716					•
HPI 503108	10.8					•
HPI 503110	11					•
HPI 50311113	11.113					•
HPI 503112	11.2					•
HPI 503115	11.5					•
HPI 50311509	11.509					•
HPI 503117	11.7					•
HPI 50311908	11.908					•

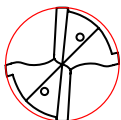
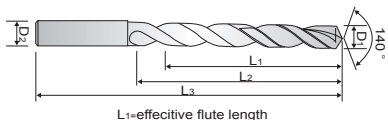

3 X D / POWER MAX DRILL-HIGH PRECISION

- Applied highly precise hole tolerance on the tool.
- Increased tool life by minimizing chatter and resonance on the (through hole) penetrated hole or (blind hole) one-side open hole area.

HPI 503 ...series



EDP. No.	D ₁	D ₂	L ₁	L ₂	L ₃	STOCK				
	mm									
HPI 503120	12	12	40	55	105	•				
HPI 503123	12.3	14	43	60	107	•				
HPI 50312304	12.304					•				
HPI 503125	12.5					•				
HPI 503127	12.7					•				
HPI 503128	12.8					•				
HPI 503130	13					•				
HPI 503133	13.3					•				
HPI 50313494	13.494					•				
HPI 503135	13.5					•				
HPI 503137	13.7					•				
HPI 50313891	13.891					•				
HPI 503140	14					•				
HPI 503141	14.1					16	45	65	115	•
HPI 503142	14.2	•								
HPI 50314288	14.288	•								
HPI 503145	14.5	•								
HPI 503147	14.7	•								
HPI 503150	15	•								
HPI 50315081	15.081	•								
HPI 503155	15.5	•								
HPI 50315875	15.875	•								
HPI 503160	16	•								
HPI 503165	16.5	18	51	73	123					•
HPI 503168	16.8									•
HPI 503170	17									•
HPI 503171	17.1					•				
HPI 50317463	17.463					•				
HPI 503175	17.5					•				
HPI 503180	18					•				
HPI 503190	19	20	55	79	131	•				
HPI 5031905	19.05					•				
HPI 503197	19.7					•				
HPI 503200	20					•				

■ Tolerance μm=1/1000mm

Tolerance \ Dia.	from 1 to 3	over 3 to 6	over 6 to 10	over 10 to 18	over 18 to 30
Cutting Edge(m7)	+12 +2	+16 +4	+21 +6	+25 +7	+29 +8
Shank(h6)	0 -6	0 -8	0 -9	0 -11	0 -13

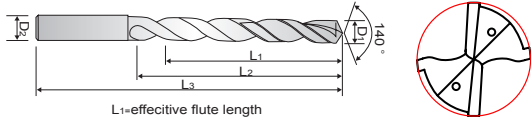

L1=effective flute length

5 X D / POWER MAX DRILL-HIGH PRECISION

- Applied highly precise hole tolerance on the tool.
- Increased tool life by minimizing chatter and resonance on the (through hole) penetrated hole or (blind hole) one-side open hole area.

HPI 505 ...series



EDP. No.	D ₁	D ₂	L ₁	L ₂	L ₃	STOCK
	mm					
HPI 50503175	3.175	6	24	30	66	•
HPI 50503264	3.264					•
HPI 50503572	3.572					•
HPI 5050397	3.97	6	29	36	74	•
HPI 505040	4					•
HPI 50504039	4.039					•
HPI 505041	4.1					•
HPI 505042	4.2					•
HPI 505043	4.3					•
HPI 50504366	4.366					•
HPI 505044	4.4					•
HPI 505045	4.5					•
HPI 5050458	4.58					•
HPI 505046	4.6					•
HPI 50504623	4.623					•
HPI 505047	4.7					•
HPI 50504763	4.763					6
HPI 505048	4.8	•				
HPI 505049	4.9	•				
HPI 505050	5	•				
HPI 505051	5.1	•				
HPI 50505159	5.159	•				
HPI 505052	5.2	•				
HPI 505053	5.3	•				
HPI 505054	5.4	•				
HPI 5050541	5.41	•				
HPI 505055	5.5	•				
HPI 50505558	5.558	•				
HPI 505056	5.6	•				
HPI 505057	5.7	•				
HPI 505058	5.8	•				
HPI 505059	5.9	•				
HPI 50505953	5.953	•				
HPI 505060	6	•				

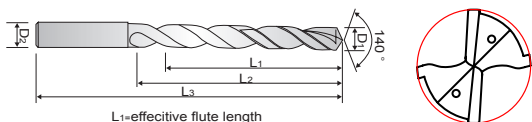

5 X D / POWER MAX DRILL-HIGH PRECISION

- Applied highly precise hole tolerance on the tool.
- Increased tool life by minimizing chatter and resonance on the (through hole) penetrated hole or (blind hole) one-side open hole area.

HPI 505 ...series



EDP. No.	D ₁	D ₂	L ₁	L ₂	L ₃	STOCK
	mm					
HPI 505061	6.1	8	43	53	91	•
HPI 505062	6.2					•
HPI 505063	6.3					•
HPI 5050635	6.35					•
HPI 505064	6.4					•
HPI 505065	6.5					•
HPI 50506528	6.528					•
HPI 505066	6.6					•
HPI 505067	6.7					•
HPI 50506747	6.747					•
HPI 505068	6.8					•
HPI 505069	6.9					•
HPI 50506909	6.909					•
HPI 505070	7					•
HPI 505071	7.1					•
HPI 50507145	7.145					•
HPI 505072	7.2					•
HPI 505073	7.3	•				
HPI 505074	7.4	•				
HPI 505075	7.5	•				
HPI 50507541	7.541	•				
HPI 505076	7.6	•				
HPI 505077	7.7	•				
HPI 505078	7.8	•				
HPI 505079	7.9	•				
HPI 50507938	7.938	•				
HPI 505080	8	10	49	61	103	•
HPI 505081	8.1					•
HPI 505082	8.2					•
HPI 505083	8.3					•
HPI 50508334	8.334					•
HPI 505084	8.4					•
HPI 50508433	8.433					•
HPI 505085	8.5					•
HPI 505086	8.6					•
HPI 505087	8.7					•
HPI 50508733	8.733	•				

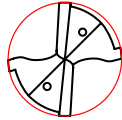
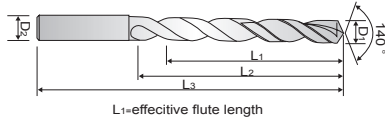

5 X D / POWER MAX DRILL-HIGH PRECISION

- Applied highly precise hole tolerance on the tool.
- Increased tool life by minimizing chatter and resonance on the (through hole) penetrated hole or (blind hole) one-side open hole area.

HPI 505 ...series



EDP. No.	D ₁			D ₂	L ₁	L ₂	L ₃	STOCK
	mm	inch	fraction					
HPI 505088	8.8	.3465	-	10	49	61	103	•
HPI 505089	8.9	.3504	-					•
HPI 505090	9	.3543	-					•
HPI 505091	9.1	.3583	-					•
HPI 50509129	9.129	.3594	23/64					•
HPI 505092	9.2	.3622	-					•
HPI 505093	9.3	.3661	-					•
HPI 50509347	9.347	.3680	-					•
HPI 505094	9.4	.3701	-					•
HPI 505095	9.5	.3740	-					•
HPI 50509525	9.525	.3750	3/8					•
HPI 505096	9.6	.3780	-					•
HPI 505097	9.7	.3819	-					•
HPI 50509703	9.703	.3820	-					•
HPI 50509746	9.746	.3837	-					•
HPI 505098	9.8	.3858	-					•
HPI 505099	9.9	.3898	-					•
HPI 50509921	9.921	.3906	25/64					•
HPI 505100	10	.3937	-					•
HPI 505101	10.1	.3976	-					12
HPI 505102	10.2	.4016	-	•				
HPI 505103	10.3	.4055	-	•				
HPI 5051032	10.32	.4063	13/32	•				
HPI 505104	10.4	.4094	-	•				
HPI 505105	10.5	.4134	-	•				
HPI 505106	10.6	.4173	-	•				
HPI 505107	10.7	.4213	-	•				
HPI 50510716	10.716	.4219	27/64	•				
HPI 505108	10.8	.4252	-	•				
HPI 505109	10.9	.4291	-	•				
HPI 505110	11	.4331	-	•				
HPI 505111	11.1	.4370	-	•				
HPI 50511113	11.113	.4375	7/16	•				
HPI 505112	11.2	.4409	-	•				
HPI 505113	11.3	.4449	-	•				
HPI 505114	11.4	.4488	-	•				
HPI 505115	11.5	.4528	-	•				

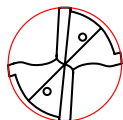
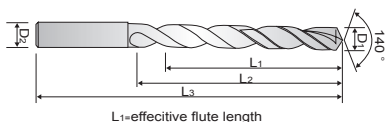

5 X D / POWER MAX DRILL-HIGH PRECISION

- Applied highly precise hole tolerance on the tool.
- Increased tool life by minimizing chatter and resonance on the (through hole) penetrated hole or (blind hole) one-side open hole area.

HPI 505 ...series



EDP. No.	D ₁			D ₂	L ₁	L ₂	L ₃	STOCK
	mm	inch	fraction					
HPI 50511509	11.509	.4531	29/64	12	56	71	118	•
HPI 505116	11.6	.4567	-					•
HPI 505117	11.7	.4606	-					•
HPI 505118	11.8	.4646	-					•
HPI 505119	11.9	.4685	-					•
HPI 50511908	11.908	.4688	15/32					•
HPI 505120	12	.4724	-	14	60	77	124	•
HPI 505121	12.1	.4764	-					•
HPI 505122	12.2	.4803	-					•
HPI 505123	12.3	.4843	-					•
HPI 50512304	12.304	.4844	31/64					•
HPI 505124	12.4	.4882	-					•
HPI 505125	12.5	.4921	-					•
HPI 505126	12.6	.4961	-					•
HPI 505127	12.7	.5000	1/2					•
HPI 505128	12.8	.5039	-					•
HPI 505129	12.9	.5079	-					•
HPI 50512903	12.903	.5080	-					•
HPI 505130	13	.5118	-					•
HPI 50513096	13.096	.5156	33/64					•
HPI 505131	13.1	.5157	-	•				
HPI 505133	13.3	.5236	-	•				
HPI 50513494	13.494	.5313	17/32	•				
HPI 505135	13.5	.5315	-	•				
HPI 505137	13.7	.5394	-	•				
HPI 505138	13.8	.5433	-	•				
HPI 50513891	13.891	.5469	35/64	•				
HPI 505140	14	.5512	-	•				
HPI 505142	14.2	.5591	-	16	63	83	133	•
HPI 50514288	14.288	.5625	9/16					•
HPI 505145	14.5	.5709	-					•
HPI 505146	14.6	.5748	-					•
HPI 505147	14.7	.5787	-					•
HPI 505149	14.9	.5866	-					•
HPI 505150	15	.5906	-					•
HPI 50515081	15.081	.5937	19/32					•
HPI 505151	15.1	.5945	-					•

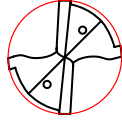
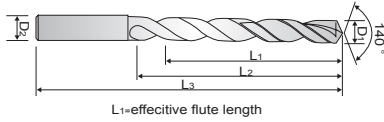

5 X D / POWER MAX DRILL-HIGH PRECISION

- Applied highly precise hole tolerance on the tool.
- Increased tool life by minimizing chatter and resonance on the (through hole) penetrated hole or (blind hole) one-side open hole area.

HPI 505 ...series



EDP. No.	D1			D2	L1	L2	L3	STOCK				
	mm	inch	fraction									
HPI 505155	15.5	.6102	-	18	63	83	133	•				
HPI 505157	15.7	.6181	-					•				
HPI 505158	15.8	.6220	-					•				
HPI 50515875	15.875	.6250	5/8					•				
HPI 505159	15.9	.6260	-					•				
HPI 505160	16	.6299	-					•				
HPI 50516078	16.078	.6330	-	18	71	93	143	•				
HPI 505162	16.2	.6378	-					•				
HPI 505164	16.4	.6457	-					•				
HPI 505165	16.5	.6496	-					•				
HPI 505166	16.6	.6535	-					•				
HPI 50516667	16.667	.6562	21/32					•				
HPI 505167	16.7	.6575	-					•				
HPI 505170	17	.6693	-					•				
HPI 50517463	17.463	.6875	11/16					•				
HPI 505175	17.5	.6890	-					•				
HPI 505177	17.7	.6969	-					•				
HPI 505180	18	.7087	-					•				
HPI 505184	18.4	.7244	-					20	77	101	153	•
HPI 505185	18.5	.7283	-									•
HPI 505186	18.6	.7323	-	•								
HPI 505188	18.8	.7402	-	•								
HPI 505190	19	.7480	-	•								
HPI 5051905	19.05	.7500	3/4	•								
HPI 505192	19.2	.7559	-	•								
HPI 50519253	19.253	.7580	-	•								
HPI 50519446	19.446	.7656	49/64	•								
HPI 505195	19.5	.7677	-	•								
HPI 505197	19.7	.7756	-	•								
HPI 50519844	19.844	.7813	25/32	•								
HPI 505200	20	.7874	-	•								

■ Tolerance mm = 1/1000mm

Tolerance \ Dia.	from 1 to 3	over 3 to 6	over 6 to 10	over 10 to 18	over 18 to 30
Cutting Edge(m7)	+12 +2	+16 +4	+21 +6	+25 +7	+29 +8
Shank(h6)	0 -6	0 -8	0 -9	0 -11	0 -13

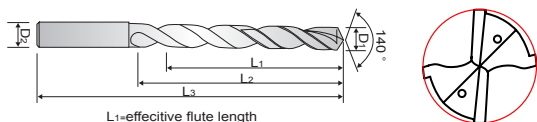

8 X D / POWER MAX DRILL-HIGH PRECISION

- Applied highly precise hole tolerance on the tool.
- Increased tool life by minimizing chatter and resonance on the (through hole) penetrated hole or (blind hole) one-side open hole area.

HPI 508 ...series



EDP. No.	D ₁	D ₂	L ₁	L ₂	L ₃	STOCK
	mm					
HPI 50803175	3.175	6	37	43	80	•
HPI 50803264	3.264					•
HPI 50803572	3.572					•
HPI 5080397	3.97	6	41	49	87	•
HPI 50804039	4.039					•
HPI 50804763	4.763	6	48	56	94	•
HPI 508050	5					•
HPI 508051	5.1					•
HPI 50805159	5.159					•
HPI 508052	5.2					•
HPI 508053	5.3					•
HPI 508055	5.5					•
HPI 50805558	5.558					•
HPI 508057	5.7					•
HPI 50805953	5.953					•
HPI 508060	6	8	57	67	105	•
HPI 508061	6.1					•
HPI 508062	6.2					•
HPI 508063	6.3					•
HPI 5080635	6.35					•
HPI 508064	6.4					•
HPI 508065	6.5					•
HPI 508066	6.6					•
HPI 508067	6.7					•
HPI 50806746	6.746					•
HPI 508068	6.8	•				
HPI 508070	7	8	61	72	110	•
HPI 50807145	7.145					•
HPI 508075	7.5					•
HPI 50807541	7.541					•
HPI 508077	7.7					•
HPI 508078	7.8					•
HPI 50807938	7.938	•				
HPI 508080	8	10	68	80	122	•
HPI 508081	8.1					•
HPI 50808334	8.334					•

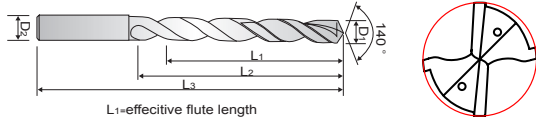

8 X D / POWER MAX DRILL-HIGH PRECISION

- Applied highly precise hole tolerance on the tool.
- Increased tool life by minimizing chatter and resonance on the (through hole) penetrated hole or (blind hole) one-side open hole area.

HPI 508 ...series



EDP. No.	D ₁	D ₂	L ₁	L ₂	L ₃	STOCK
	mm					
HPI 508085	8.5	10	68	80	122	•
HPI 508086	8.6					•
HPI 508087	8.7					•
HPI 50808733	8.733					•
HPI 508088	8.8					•
HPI 508090	9					•
HPI 508091	9.1					•
HPI 50809129	9.129					•
HPI 508095	9.5					•
HPI 50809525	9.525					•
HPI 508097	9.7					•
HPI 508098	9.8					•
HPI 508099	9.9					•
HPI 50809921	9.921					•
HPI 508100	10					•
HPI 508101	10.1	12	79	94	141	•
HPI 508102	10.2					•
HPI 508103	10.3					•
HPI 5081032	10.32					•
HPI 508105	10.5					•
HPI 50810716	10.716					•
HPI 508108	10.8					•
HPI 508110	11					•
HPI 50811113	11.113					•
HPI 508112	11.2					•
HPI 508113	11.3					•
HPI 508114	11.4					•
HPI 508115	11.5					•
HPI 50811509	11.509					•
HPI 508117	11.7					•
HPI 508118	11.8	•				
HPI 50811908	11.908	•				
HPI 508120	12	•				
HPI 50812304	12.304	14	91	108	155	•
HPI 508125	12.5					•
HPI 508127	12.7					•

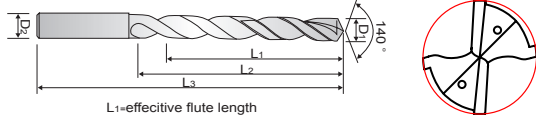

8 X D / POWER MAX DRILL-HIGH PRECISION

- Applied highly precise hole tolerance on the tool.
- Increased tool life by minimizing chatter and resonance on the (through hole) penetrated hole or (blind hole) one-side open hole area.

HPI 508 ...series



EDP. No.	D ₁			D ₂	L ₁	L ₂	L ₃	STOCK
	mm	inch	fraction					
HPI 508128	12.8	.5039	-	14	91	108	155	•
HPI 508130	13	.5118	-					•
HPI 508135	13.5	.5315	-					•
HPI 508140	14	.5512	-					•
HPI 50814288	14.288	.5625	9/16	16	101	121	171	•
HPI 508145	14.5	.5709	-					•
HPI 508150	15	.5906	-					•
HPI 508151	15.1	.5945	-					•
HPI 508152	15.2	.5984	-					•
HPI 508153	15.3	.6024	-					•
HPI 508155	15.5	.6102	-					•
HPI 508158	15.8	.6220	-					•
HPI 50815875	15.875	.6250	5/8					•
HPI 508160	16	.6299	-					•
HPI 50816078	16.078	.6330	-					18
HPI 508162	16.2	.6378	-	•				
HPI 508165	16.5	.6496	-	•				
HPI 508170	17	.6693	-	•				
HPI 50817463	17.463	.6875	11/16	•				
HPI 508175	17.5	.6890	-	•				
HPI 508180	18	.7087	-	•				
HPI 508185	18.5	.7283	-	20	124	148	200	•
HPI 508190	19	.7480	-					•
HPI 5081905	19.05	.7500	3/4					•
HPI 50819253	19.253	.7580	-					•
HPI 508198	19.8	.7795	-					•
HPI 508200	20	.7874	-					•

■ Tolerance μm=1/1000mm

Tolerance \ Dia.	from 1 to 3	over 3 to 6	over 6 to 10	over 10 to 18	over 18 to 30
Cutting Edge(m7)	+12 +2	+16 +4	+21 +6	+25 +7	+29 +8
Shank(h6)	0 -6	0 -8	0 -9	0 -11	0 -13

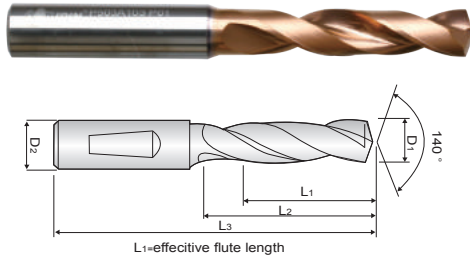

POWER MAX DRILL - STUB / DIN 6537K

- Shank Form
- P503A : DIN 6535 HA - straight A type
- P503F : DIN 6535 HE - 2° Whistle Flat F type

P503A / P503F ...series



EDP. No.	EDP. No.	D ₁ (m7)	D ₂ (h6)	L ₁	L ₂	L ₃	STOCK
P503A030	P503F030	3.0	6	14	20	62	
P503A031	P503F031	3.1					
P503A032	P503F032	3.2					
P503A033	P503F033	3.3					
P503A034	P503F034	3.4					
P503A035	P503F035	3.5					
P503A036	P503F036	3.6					
P503A037	P503F037	3.7					
P503A038	P503F038	3.8	6	17	24	66	
P503A039	P503F039	3.9					
P503A040	P503F040	4.0					
P503A041	P503F041	4.1					
P503A042	P503F042	4.2					
P503A043	P503F043	4.3					
P503A044	P503F044	4.4					
P503A045	P503F045	4.5					
P503A046	P503F046	4.6					
P503A047	P503F047	4.7					
P503A048	P503F048	4.8	6	20	28	66	
P503A049	P503F049	4.9					
P503A050	P503F050	5.0					
P503A051	P503F051	5.1					
P503A052	P503F052	5.2					
P503A053	P503F053	5.3					
P503A054	P503F054	5.4					
P503A055	P503F055	5.5					
P503A056	P503F056	5.6					
P503A057	P503F057	5.7					
P503A058	P503F058	5.8					
P503A059	P503F059	5.9					
P503A060	P503F060	6.0					
P503A061	P503F061	6.1	8	24	34	79	
P503A062	P503F062	6.2					
P503A063	P503F063	6.3					
P503A064	P503F064	6.4					
P503A065	P503F065	6.5					
P503A066	P503F066	6.6					

※ These tools are manufactured based on order received.

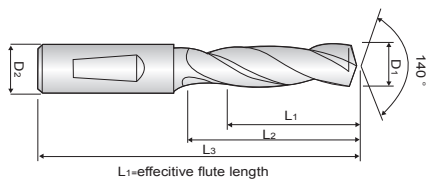

POWER MAX DRILL - STUB / DIN 6537K

- Shank Form
- P503A : DIN 6535 HA - straight A type
- P503F : DIN 6535 HE - 2° Whistle Flat F type

P503A / P503F ...series



EDP. No.	EDP. No.	D ₁ (m7)	D ₂ (h6)	L ₁	L ₂	L ₃	STOCK
P503A067	P503F067	6.7	8	24	34	79	
P503A068	P503F068	6.8					
P503A069	P503F069	6.9					
P503A070	P503F070	7.0					
P503A071	P503F071	7.1	8	29	41	79	
P503A072	P503F072	7.2					
P503A073	P503F073	7.3					
P503A074	P503F074	7.4					
P503A075	P503F075	7.5					
P503A076	P503F076	7.6					
P503A077	P503F077	7.7					
P503A078	P503F078	7.8					
P503A079	P503F079	7.9					
P503A080	P503F080	8.0					
P503A081	P503F081	8.1	10	35	47	89	
P503A082	P503F082	8.2					
P503A083	P503F083	8.3					
P503A084	P503F084	8.4					
P503A085	P503F085	8.5					
P503A086	P503F086	8.6					
P503A087	P503F087	8.7					
P503A088	P503F088	8.8					
P503A089	P503F089	8.9					
P503A090	P503F090	9.0					
P503A091	P503F091	9.1					
P503A092	P503F092	9.2					
P503A093	P503F093	9.3					
P503A094	P503F094	9.4					
P503A095	P503F095	9.5					
P503A096	P503F096	9.6					
P503A097	P503F097	9.7					
P503A098	P503F098	9.8					
P503A099	P503F099	9.9					
P503A100	P503F100	10.0					
P503A101	P503F101	10.1	12	40	55	102	
P503A102	P503F102	10.2					
P503A103	P503F103	10.3					

※ These tools are manufactured based on order received.

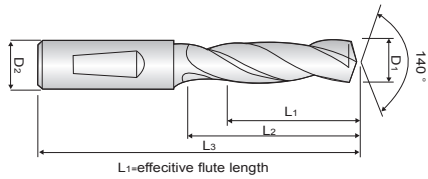

POWER MAX DRILL - STUB / DIN 6537K

- Shank Form
- P503A : DIN 6535 HA - straight A type
- P503F : DIN 6535 HE - 2° Whistle Flat F type

P503A / P503F ...series



EDP. No.	EDP. No.	D ₁ (m7)	D ₂ (h6)	L ₁	L ₂	L ₃	STOCK
P503A104	P503F104	10.4	12	40	55	102	
P503A105	P503F105	10.5					
P503A106	P503F106	10.6					
P503A107	P503F107	10.7					
P503A108	P503F108	10.8					
P503A109	P503F109	10.9					
P503A110	P503F110	11.0					
P503A111	P503F111	11.1					
P503A112	P503F112	11.2					
P503A113	P503F113	11.3					
P503A114	P503F114	11.4					
P503A115	P503F115	11.5					
P503A116	P503F116	11.6					
P503A117	P503F117	11.7					
P503A118	P503F118	11.8					
P503A119	P503F119	11.9					
P503A120	P503F120	12.0	14	43	60	107	
P503A121	P503F121	12.1					
P503A122	P503F122	12.2					
P503A123	P503F123	12.3					
P503A124	P503F124	12.4					
P503A125	P503F125	12.5					
P503A126	P503F126	12.6					
P503A127	P503F127	12.7					
P503A128	P503F128	12.8					
P503A129	P503F129	12.9					
P503A130	P503F130	13.0					
P503A131	P503F131	13.1					
P503A132	P503F132	13.2					
P503A133	P503F133	13.3					
P503A134	P503F134	13.4					
P503A135	P503F135	13.5					
P503A136	P503F136	13.6					
P503A137	P503F137	13.7					
P503A138	P503F138	13.8					
P503A139	P503F139	13.9					
P503A140	P503F140	14.0					

※ These tools are manufactured based on order received.

EDP. No.	EDP. No.	D ₁ (m7)	D ₂ (h6)	L ₁	L ₂	L ₃	STOCK
P503A141	P503F141	14.1	16	45	65	115	
P503A142	P503F142	14.2					
P503A143	P503F143	14.3					
P503A144	P503F144	14.4					
P503A145	P503F145	14.5					
P503A146	P503F146	14.6					
P503A147	P503F147	14.7					
P503A148	P503F148	14.8					
P503A149	P503F149	14.9					
P503A150	P503F150	15.0					
P503A151	P503F151	15.1					
P503A152	P503F152	15.2					
P503A153	P503F153	15.3					
P503A154	P503F154	15.4					
P503A155	P503F155	15.5					
P503A156	P503F156	15.6					
P503A157	P503F157	15.7					
P503A158	P503F158	15.8					
P503A159	P503F159	15.9					
P503A160	P503F160	16.0					
P503A161	P503F161	16.1	18	51	73	123	
P503A163	P503F163	16.3					
P503A165	P503F165	16.5					
P503A170	P503F170	17.0					
P503A171	P503F171	17.1					
P503A172	P503F172	17.2					
P503A175	P503F175	17.5					
P503A177	P503F177	17.7					
P503A178	P503F178	17.8					
P503A180	P503F180	18.0					
P503A181	P503F181	18.1	20	55	79	131	
P503A182	P503F182	18.2					
P503A185	P503F185	18.5					
P503A190	P503F190	19.0					
P503A191	P503F191	19.1					
P503A195	P503F195	19.5					
P503A197	P503F197	19.7					
P503A200	P503F200	20.0					

※ These tools are manufactured based on order received.

■ Tolerance		μm=1/1000mm				
Tolerance	Dia.	from 1 to 3	over 3 to 6	over 6 to 10	over 10 to 18	over 18 to 30
Cutting Edge(m7)		+12 +2	+16 +4	+21 +6	+25 +7	+29 +8
Shank(h6)		0 -6	0 -8	0 -9	0 -11	0 -13

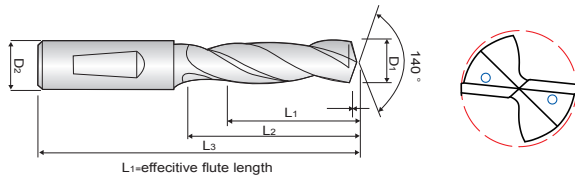

**POWER MX DRILL
STUB INTERNAL COOLANT / DIN 6537K**

- Shank Form
- PI503A : DIN 6535 HA - straight A type
- PI503F : DIN 6535 HE - 2° Whistle Flat F type

PI503A / PI503F ...series



EDP. No.	EDP. No.	D ₁ (m7)	D ₂ (h6)	L ₁	L ₂	L ₃	STOCK
PI503A030	PI503F030	3.0	6	14	20	62	
PI503A031	PI503F031	3.1					
PI503A032	PI503F032	3.2					
PI503A033	PI503F033	3.3					
PI503A034	PI503F034	3.4					
PI503A035	PI503F035	3.5					
PI503A036	PI503F036	3.6					
PI503A037	PI503F037	3.7					
PI503A038	PI503F038	3.8	6	17	24	66	
PI503A039	PI503F039	3.9					
PI503A040	PI503F040	4.0					
PI503A041	PI503F041	4.1					
PI503A042	PI503F042	4.2					
PI503A043	PI503F043	4.3					
PI503A044	PI503F044	4.4					
PI503A045	PI503F045	4.5					
PI503A046	PI503F046	4.6					
PI503A047	PI503F047	4.7					
PI503A048	PI503F048	4.8	6	20	28	66	
PI503A049	PI503F049	4.9					
PI503A050	PI503F050	5.0					
PI503A051	PI503F051	5.1					
PI503A052	PI503F052	5.2					
PI503A053	PI503F053	5.3					
PI503A054	PI503F054	5.4					
PI503A055	PI503F055	5.5					
PI503A056	PI503F056	5.6					
PI503A057	PI503F057	5.7					
PI503A058	PI503F058	5.8					
PI503A059	PI503F059	5.9					
PI503A060	PI503F060	6.0					
PI503A061	PI503F061	6.1	8	24	34	79	
PI503A062	PI503F062	6.2					
PI503A063	PI503F063	6.3					
PI503A064	PI503F064	6.4					
PI503A065	PI503F065	6.5					
PI503A066	PI503F066	6.6					

※ These tools are manufactured based on order received.

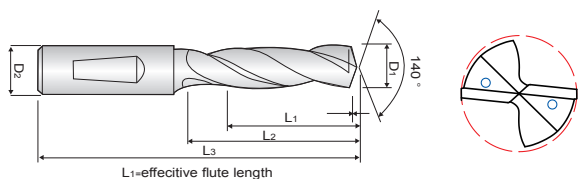

**POWER MX DRILL
STUB INTERNAL COOLANT / DIN 6537K**

- Shank Form
- PI503A : DIN 6535 HA - straight A type
- PI503F : DIN 6535 HE - 2° Whistle Flat F type

PI503A / PI503F ...series



EDP. No.	EDP. No.	D ₁ (m7)	D ₂ (h6)	L ₁	L ₂	L ₃	STOCK
PI503A067	PI503F067	6.7	8	24	34	79	
PI503A068	PI503F068	6.8					
PI503A069	PI503F069	6.9					
PI503A070	PI503F070	7.0					
PI503A071	PI503F071	7.1	8	29	41	79	
PI503A072	PI503F072	7.2					
PI503A073	PI503F073	7.3					
PI503A074	PI503F074	7.4					
PI503A075	PI503F075	7.5					
PI503A076	PI503F076	7.6					
PI503A077	PI503F077	7.7					
PI503A078	PI503F078	7.8					
PI503A079	PI503F079	7.9					
PI503A080	PI503F080	8.0					
PI503A081	PI503F081	8.1	10	35	47	89	
PI503A082	PI503F082	8.2					
PI503A083	PI503F083	8.3					
PI503A084	PI503F084	8.4					
PI503A085	PI503F085	8.5					
PI503A086	PI503F086	8.6					
PI503A087	PI503F087	8.7					
PI503A088	PI503F088	8.8					
PI503A089	PI503F089	8.9					
PI503A090	PI503F090	9.0					
PI503A091	PI503F091	9.1					
PI503A092	PI503F092	9.2					
PI503A093	PI503F093	9.3					
PI503A094	PI503F094	9.4					
PI503A095	PI503F095	9.5					
PI503A096	PI503F096	9.6					
PI503A097	PI503F097	9.7					
PI503A098	PI503F098	9.8					
PI503A099	PI503F099	9.9					
PI503A100	PI503F100	10.0					
PI503A101	PI503F101	10.1	12	40	55	102	
PI503A102	PI503F102	10.2					
PI503A103	PI503F103	10.3					

※ These tools are manufactured based on order received.

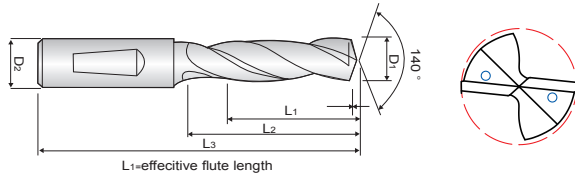

L1-effective flute length

**POWER MX DRILL
STUB INTERNAL COOLANT / DIN 6537K**

- Shank Form
- PI503A : DIN 6535 HA - straight A type
- PI503F : DIN 6535 HE - 2° Whistle Flat F type

PI503A / PI503F ...series



EDP. No.	EDP. No.	D ₁ (m7)	D ₂ (h6)	L ₁	L ₂	L ₃	STOCK
PI503A104	PI503F104	10.4	12	40	55	102	
PI503A105	PI503F105	10.5					
PI503A106	PI503F106	10.6					
PI503A107	PI503F107	10.7					
PI503A108	PI503F108	10.8					
PI503A109	PI503F109	10.9					
PI503A110	PI503F110	11.0					
PI503A111	PI503F111	11.1					
PI503A112	PI503F112	11.2					
PI503A113	PI503F113	11.3					
PI503A114	PI503F114	11.4					
PI503A115	PI503F115	11.5					
PI503A116	PI503F116	11.6					
PI503A117	PI503F117	11.7					
PI503A118	PI503F118	11.8					
PI503A119	PI503F119	11.9					
PI503A120	PI503F120	12.0	14	43	60	107	
PI503A121	PI503F121	12.1					
PI503A122	PI503F122	12.2					
PI503A123	PI503F123	12.3					
PI503A124	PI503F124	12.4					
PI503A125	PI503F125	12.5					
PI503A126	PI503F126	12.6					
PI503A127	PI503F127	12.7					
PI503A128	PI503F128	12.8					
PI503A129	PI503F129	12.9					
PI503A130	PI503F130	13.0					
PI503A131	PI503F131	13.1					
PI503A132	PI503F132	13.2					
PI503A133	PI503F133	13.3					
PI503A134	PI503F134	13.4					
PI503A135	PI503F135	13.5					
PI503A136	PI503F136	13.6					
PI503A137	PI503F137	13.7					
PI503A138	PI503F138	13.8					
PI503A139	PI503F139	13.9					
PI503A140	PI503F140	14.0					

※ These tools are manufactured based on order received.

EDP. No.	EDP. No.	D ₁ (m7)	D ₂ (h6)	L ₁	L ₂	L ₃	STOCK
PI503A141	PI503F141	14.1	16	45	65	115	
PI503A142	PI503F142	14.2					
PI503A143	PI503F143	14.3					
PI503A144	PI503F144	14.4					
PI503A145	PI503F145	14.5					
PI503A146	PI503F146	14.6					
PI503A147	PI503F147	14.7					
PI503A148	PI503F148	14.8					
PI503A149	PI503F149	14.9					
PI503A150	PI503F150	15.0					
PI503A151	PI503F151	15.1					
PI503A152	PI503F152	15.2					
PI503A153	PI503F153	15.3					
PI503A154	PI503F154	15.4					
PI503A155	PI503F155	15.5					
PI503A156	PI503F156	15.6					
PI503A157	PI503F157	15.7					
PI503A158	PI503F158	15.8					
PI503A159	PI503F159	15.9					
PI503A160	PI503F160	16.0					
PI503A161	PI503F161	16.1	18	51	73	123	
PI503A163	PI503F163	16.3					
PI503A165	PI503F165	16.5					
PI503A170	PI503F170	17.0					
PI503A171	PI503F171	17.1					
PI503A172	PI503F172	17.2					
PI503A175	PI503F175	17.5					
PI503A177	PI503F177	17.7					
PI503A178	PI503F178	17.8					
PI503A180	PI503F180	18.0					
PI503A181	PI503F181	18.1	20	55	79	131	
PI503A182	PI503F182	18.2					
PI503A185	PI503F185	18.5					
PI503A190	PI503F190	19.0					
PI503A191	PI503F191	19.1					
PI503A195	PI503F195	19.5					
PI503A197	PI503F197	19.7					
PI503A200	PI503F200	20.0					

※ These tools are manufactured based on order received.

■ Tolerance		μm=1/1000mm				
Tolerance	Dia.	from 1 to 3	over 3 to 6	over 6 to 10	over 10 to 18	over 18 to 30
Cutting Edge(m7)		+12 +2	+16 +4	+21 +6	+25 +7	+29 +8
Shank(h6)		0 -6	0 -8	0 -9	0 -11	0 -13

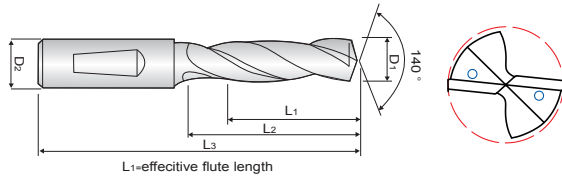

MEDIUM INTERNAL COOLANT / DIN 6537L

- Shank Form
- PI505A : DIN 6535 HA - straight A type
- PI505F : DIN 6535 HE - 2° Whistle Flat F type

PI505A / PI505F ...series



EDP. No.	EDP. No.	D ₁ (m7)	D ₂ (h6)	L ₁	L ₂	L ₃	STOCK
PI505A040	PI505F040	4.0	6	29	36	74	
PI505A041	PI505F041	4.1					
PI505A042	PI505F042	4.2					
PI505A043	PI505F043	4.3					
PI505A044	PI505F044	4.4					
PI505A045	PI505F045	4.5					
PI505A046	PI505F046	4.6					
PI505A047	PI505F047	4.7					
PI505A048	PI505F048	4.8	6	35	44	82	
PI505A049	PI505F049	4.9					
PI505A050	PI505F050	5.0					
PI505A051	PI505F051	5.1					
PI505A052	PI505F052	5.2					
PI505A053	PI505F053	5.3					
PI505A054	PI505F054	5.4					
PI505A055	PI505F055	5.5					
PI505A056	PI505F056	5.6					
PI505A057	PI505F057	5.7					
PI505A058	PI505F058	5.8					
PI505A059	PI505F059	5.9					
PI505A060	PI505F060	6.0					
PI505A061	PI505F061	6.1	8	43	53	91	
PI505A062	PI505F062	6.2					
PI505A063	PI505F063	6.3					
PI505A064	PI505F064	6.4					
PI505A065	PI505F065	6.5					
PI505A066	PI505F066	6.6					
PI505A067	PI505F067	6.7					
PI505A068	PI505F068	6.8					
PI505A069	PI505F069	6.9					
PI505A070	PI505F070	7.0					
PI505A071	PI505F071	7.1					
PI505A072	PI505F072	7.2					
PI505A073	PI505F073	7.3					
PI505A074	PI505F074	7.4					
PI505A075	PI505F075	7.5					
PI505A076	PI505F076	7.6					

※ These tools are manufactured based on order received.

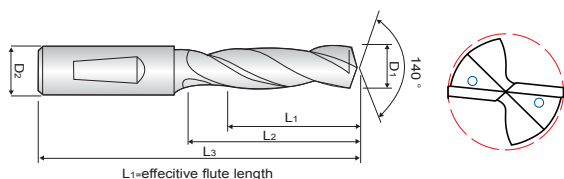

MEDIUM INTERNAL COOLANT / DIN 6537L

- Shank Form
- PI505A : DIN 6535 HA - straight A type
- PI505F : DIN 6535 HE - 2° Whistle Flat F type

PI505A / PI505F ...series



EDP. No.	EDP. No.	D ₁ (m7)	D ₂ (h6)	L ₁	L ₂	L ₃	STOCK
PI505A077	PI505F077	7.7	8	43	53	91	
PI505A078	PI505F078	7.8					
PI505A079	PI505F079	7.9					
PI505A080	PI505F080	8.0					
PI505A081	PI505F081	8.1	10	49	61	103	
PI505A082	PI505F082	8.2					
PI505A083	PI505F083	8.3					
PI505A084	PI505F084	8.4					
PI505A085	PI505F085	8.5					
PI505A086	PI505F086	8.6					
PI505A087	PI505F087	8.7					
PI505A088	PI505F088	8.8					
PI505A089	PI505F089	8.9					
PI505A090	PI505F090	9.0					
PI505A091	PI505F091	9.1					
PI505A092	PI505F092	9.2					
PI505A093	PI505F093	9.3					
PI505A094	PI505F094	9.4					
PI505A095	PI505F095	9.5					
PI505A096	PI505F096	9.6					
PI505A097	PI505F097	9.7					
PI505A098	PI505F098	9.8					
PI505A099	PI505F099	9.9					
PI505A100	PI505F100	10.0	12	56	71	118	
PI505A101	PI505F101	10.1					
PI505A102	PI505F102	10.2					
PI505A103	PI505F103	10.3					
PI505A104	PI505F104	10.4					
PI505A105	PI505F105	10.5					
PI505A106	PI505F106	10.6					
PI505A107	PI505F107	10.7					
PI505A108	PI505F108	10.8					
PI505A109	PI505F109	10.9					
PI505A110	PI505F110	11.0					
PI505A111	PI505F111	11.1					
PI505A112	PI505F112	11.2					
PI505A113	PI505F113	11.3					

※ These tools are manufactured based on order received.

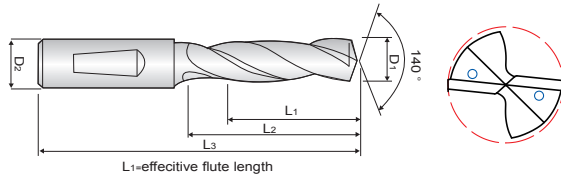

MEDIUM INTERNAL COOLANT / DIN 6537L

- Shank Form
- PI505A : DIN 6535 HA - straight A type
- PI505F : DIN 6535 HE - 2° Whistle Flat F type

PI505A / PI505F ...series



EDP. No.	EDP. No.	D ₁ (m7)	D ₂ (h6)	L ₁	L ₂	L ₃	STOCK
PI505A114	PI505F114	11.4	12	56	71	118	
PI505A115	PI505F115	11.5					
PI505A116	PI505F116	11.6					
PI505A117	PI505F117	11.7					
PI505A118	PI505F118	11.8					
PI505A119	PI505F119	11.9					
PI505A120	PI505F120	12.0					
PI505A121	PI505F121	12.1					
PI505A122	PI505F122	12.2					
PI505A123	PI505F123	12.3					
PI505A124	PI505F124	12.4					
PI505A125	PI505F125	12.5					
PI505A126	PI505F126	12.6					
PI505A127	PI505F127	12.7					
PI505A128	PI505F128	12.8					
PI505A129	PI505F129	12.9					
PI505A130	PI505F130	13.0					
PI505A131	PI505F131	13.1					
PI505A132	PI505F132	13.2					
PI505A133	PI505F133	13.3					
PI505A134	PI505F134	13.4					
PI505A135	PI505F135	13.5					
PI505A136	PI505F136	13.6					
PI505A137	PI505F137	13.7					
PI505A138	PI505F138	13.8					
PI505A139	PI505F139	13.9					
PI505A140	PI505F140	14.0	16	63	83	133	
PI505A141	PI505F141	14.1					
PI505A142	PI505F142	14.2					
PI505A143	PI505F143	14.3					
PI505A144	PI505F144	14.4					
PI505A145	PI505F145	14.5					
PI505A146	PI505F146	14.6					
PI505A147	PI505F147	14.7					
PI505A148	PI505F148	14.8					
PI505A149	PI505F149	14.9					
PI505A150	PI505F150	15.0					

※ These tools are manufactured based on order received.

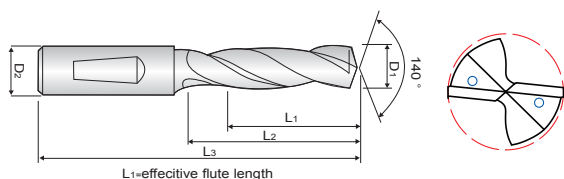

MEDIUM INTERNAL COOLANT / DIN 6537L

- Shank Form
- PI505A : DIN 6535 HA - straight A type
- PI505F : DIN 6535 HE - 2° Whistle Flat F type

PI505A / PI505F ...series



EDP. No.	EDP. No.	D ₁ (m7)	D ₂ (h6)	L ₁	L ₂	L ₃	STOCK
PI505A151	PI505F151	15.1	16	63	83	133	
PI505A152	PI505F152	15.2					
PI505A153	PI505F153	15.3					
PI505A154	PI505F154	15.4					
PI505A155	PI505F155	15.5					
PI505A156	PI505F156	15.6					
PI505A157	PI505F157	15.7					
PI505A158	PI505F158	15.8					
PI505A159	PI505F159	15.9					
PI505A160	PI505F160	16.0					
PI505A161	PI505F161	16.1	18	71	93	143	
PI505A163	PI505F163	16.3					
PI505A165	PI505F165	16.5					
PI505A170	PI505F170	17.0					
PI505A171	PI505F171	17.1					
PI505A172	PI505F172	17.2					
PI505A175	PI505F175	17.5					
PI505A177	PI505F177	17.7					
PI505A178	PI505F178	17.8					
PI505A180	PI505F180	18.0					
PI505A181	PI505F181	18.1	20	77	101	153	
PI505A182	PI505F182	18.2					
PI505A185	PI505F185	18.5					
PI505A190	PI505F190	19.0					
PI505A191	PI505F191	19.1					
PI505A195	PI505F195	19.5					
PI505A197	PI505F197	19.7					
PI505A200	PI505F200	20.0					

※ These tools are manufactured based on order received.

■ Tolerance μm=1/1000mm

Tolerance	Dia.	from 1 to 3	over 3 to 6	over 6 to 10	over 10 to 18	over 18 to 30
Cutting Edge(m7)		+12 +2	+16 +4	+21 +6	+25 +7	+29 +8
Shank(h6)		0 -6	0 -8	0 -9	0 -11	0 -13

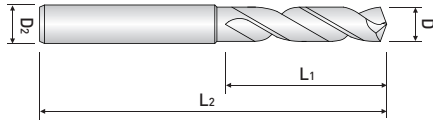

POWER DRILL - STUB / 3 x D

PDS ...series



EDP. No.	Dia.	L1	L2	D2	STOCK
PDS010	1	8	38	3	•
PDS011	1.1	10	42		•
PDS012	1.2				•
PDS013	1.3				•
PDS014	1.4				•
PDS015	1.5				•
PDS016	1.6				•
PDS017	1.7				•
PDS018	1.8				•
PDS019	1.9				•
PDS 020	2.0				14
PDS 021	2.1	•			
PDS 022	2.2	•			
PDS 023	2.3	•			
PDS 024	2.4	•			
PDS 025	2.5	•			
PDS 026	2.6	•			
PDS 027	2.7	•			
PDS 028	2.8	•			
PDS 029	2.9	•			
PDS 030	3.0	18	60	•	
PDS 031	3.1	22	60	•	
PDS 032	3.2			•	
PDS 033	3.3			•	
PDS 034	3.4			•	
PDS 035	3.5			•	
PDS 036	3.6			•	
PDS 037	3.7			•	
PDS 038	3.8			•	
PDS 039	3.9			•	
PDS 040	4.0			•	
PDS 041	4.1	24	62	•	
PDS 042	4.2	26		•	
PDS 043	4.3			•	
PDS 044	4.4			•	
PDS 045	4.5			•	
PDS 046	4.6			•	
PDS 047	4.7			•	
PDS 048	4.8			•	
PDS 049	4.9			•	
PDS 050	5.0			•	
PDS 051	5.1		28	66	6

EDP. No.	Dia.	L1	L2	D2	STOCK			
PDS 052	5.2	28	66	6	•			
PDS 053	5.3				•			
PDS 054	5.4				•			
PDS 055	5.5				•			
PDS 056	5.6				•			
PDS 057	5.7	30	74	7	•			
PDS 058	5.8				•			
PDS 059	5.9				•			
PDS 060	6.0				•			
PDS 061	6.1				•			
PDS 062	6.2	34	74	7	•			
PDS 063	6.3				•			
PDS 064	6.4				•			
PDS 065	6.5				•			
PDS 066	6.6				•			
PDS 067	6.7				37	79	8	•
PDS 068	6.8							•
PDS 069	6.9							•
PDS 070	7.0							•
PDS 071	7.1				40	84	9	•
PDS 072	7.2	•						
PDS 073	7.3	•						
PDS 074	7.4	•						
PDS 075	7.5	•						
PDS 076	7.6	•						
PDS 077	7.7	•						
PDS 078	7.8	•						
PDS 079	7.9	•						
PDS 080	8.0	•						
PDS 081	8.1	43	84	9	•			
PDS 082	8.2				•			
PDS 083	8.3				•			
PDS 084	8.4				•			
PDS 085	8.5				•			
PDS 086	8.6				•			
PDS 087	8.7				•			
PDS 088	8.8				•			
PDS 089	8.9				•			
PDS 090	9.0				•			
PDS 091	9.1	47	89	10	•			
PDS 092	9.2				•			
PDS 093	9.3				•			

EDP. No.	Dia.	L ₁	L ₂	D ₂	STOCK
PDS 094	9.4	47	89	10	•
PDS 095	9.5				•
PDS 096	9.6				•
PDS 097	9.7				•
PDS 098	9.8				•
PDS 099	9.9				•
PDS 100	10.0				•
PDS 101	10.1	51	95	11	•
PDS 102	10.2				•
PDS 103	10.3				•
PDS 104	10.4				•
PDS 105	10.5				•
PDS 106	10.6				•
PDS 107	10.7				•
PDS 108	10.8				•
PDS 109	10.9				•
PDS 110	11.0				•
PDS 111	11.1	54	102	12	•
PDS 112	11.2				•
PDS 113	11.3				•
PDS 114	11.4				•
PDS 115	11.5				•
PDS 116	11.6				•
PDS 117	11.7				•
PDS 118	11.8				•
PDS 119	11.9				•
PDS 120	12.0				•
PDS 121	12.1	57	102	13	•
PDS 122	12.2				•
PDS 123	12.3				•
PDS 124	12.4				•
PDS 125	12.5				•
PDS 126	12.6				•
PDS 127	12.7				•
PDS 128	12.8				•
PDS 129	12.9				•
PDS 130	13.0				•
PDS 131	13.1	60	107	14	•
PDS 132	13.2				•
PDS 133	13.3				•
PDS 132	13.4				•
PDS 135	13.5				•
PDS 136	13.6				•
PDS 137	13.7				•
PDS 138	13.8				•
PDS 139	13.9				•
PDS 140	14.0				•

EDP. No.	Dia.	L ₁	L ₂	D ₂	STOCK			
PDS 141	14.1	62	111	15	•			
PDS 142	14.2				•			
PDS 143	14.3				•			
PDS 144	14.4				•			
PDS 145	14.5				•			
PDS 146	14.6				•			
PDS 147	14.7				•			
PDS 148	14.8				•			
PDS 149	14.9				•			
PDS 150	15.0				•			
PDS 151	15.1	64	115	16	•			
PDS 152	15.2				•			
PDS 154	15.4				•			
PDS 155	15.5				•			
PDS 156	15.6				•			
PDS 157	15.7				•			
PDS 158	15.8				•			
PDS 159	15.9				•			
PDS 160	16.0				•			
PDS 161	16.1				66	119	17	•
PDS 163	16.3	•						
PDS 164	16.4	•						
PDS 165	16.5	•						
PDS 170	17.0	•						
PDS 171	17.1	66	123	18	•			
PDS 172	17.2				•			
PDS 173	17.3				•			
PDS 175	17.5				•			
PDS 177	17.7				•			
PDS 178	17.8				•			
PDS 180	18.0				•			
PDS 181	18.1				70	127	19	•
PDS 182	18.2							•
PDS 185	18.5							•
PDS 190	19.0	•						
PDS 191	19.1	70	131	20	•			
PDS 192	19.2				•			
PDS 195	19.5				•			
PDS 197	19.7				•			
PDS 200	20.0				•			
PDS 220	22.0	75	131	22	•			
PDS 225	22.5	80	131	23	•			
PDS 230	23.0	86	140	23	•			
PDS 235	23.5	86	140	24	•			
PDS 240	24.0							

■ Tolerance μm=1/1000mm

Tolerance	Dia.	from 1 to 3	over 3 to 6	over 6 to 10	over 10 to 18	over 18 to 30
Cutting Edge(h8)		0 -14	0 -18	0 -22	0 -27	0 -33
Shank(h6)		0 -6	0 -8	0 -9	0 -11	0 -13

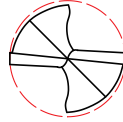
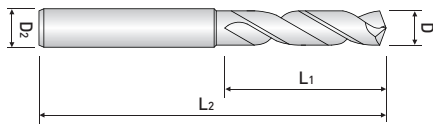

POWER DRILL - MEDIUM / 5 x D

PDM ...series



EDP. No.	Dia.	L1	L2	D2	STOCK			
PDM 030	3.0	25	60	3	•			
PDM 031	3.1	27			•			
PDM 032	3.2				•			
PDM 033	3.3				•			
PDM 034	3.4				•			
PDM 035	3.5		30	65	4	•		
PDM 036	3.6	•						
PDM 037	3.7	•						
PDM 038	3.8	•						
PDM 039	3.9	33				71	7	•
PDM 040	4.0		•					
PDM 041	4.1		33	71	5			•
PDM 042	4.2							•
PDM 043	4.3							•
PDM 044	4.4	36				71	5	•
PDM 045	4.5							•
PDM 046	4.6		•					
PDM 047	4.7		•					
PDM 048	4.8		39	71	5			•
PDM 049	4.9	•						
PDM 050	5.0	•						
PDM 051	5.1	39				83	6	•
PDM 052	5.2							•
PDM 053	5.3		•					
PDM 054	5.4		43	83	6			•
PDM 055	5.5							•
PDM 056	5.6	•						
PDM 057	5.7	•						
PDM 058	5.8	•						
PDM 059	5.9	47	87	7	•			
PDM 060	6.0				•			
PDM 061	6.1				•			
PDM 062	6.2				•			
PDM 063	6.3				•			
PDM 064	6.4	•						
PDM 065	6.5	•						
PDM 066	6.6	•						

EDP. No.	Dia.	L1	L2	D2	STOCK			
PDM 067	6.7	47	87	7	•			
PDM 068	6.8				•			
PDM 069	6.9				•			
PDM 070	7.0				•			
PDM 071	7.1				52	92	8	•
PDM 072	7.2	•						
PDM 073	7.3	•						
PDM 074	7.4	•						
PDM 075	7.5	56	96	9				•
PDM 076	7.6				•			
PDM 077	7.7				•			
PDM 078	7.8				•			
PDM 079	7.9				62	105	10	•
PDM 080	8.0	•						
PDM 081	8.1	68	115	11				•
PDM 082	8.2							•
PDM 083	8.3							•
PDM 084	8.4				•			
PDM 085	8.5				72	120	12	•
PDM 086	8.6	•						
PDM 087	8.7	•						
PDM 088	8.8	•						
PDM 089	8.9	78	126	13				•
PDM 090	9.0				•			
PDM 091	9.1				84	132	14	•
PDM 092	9.2							•
PDM 093	9.3							•
PDM 094	9.4	•						
PDM 095	9.5	90	138	15				•
PDM 096	9.6				•			
PDM 097	9.7				•			
PDM 098	9.8				•			
PDM 099	9.9				96	144	16	•
PDM 100	10.0	•						
PDM 101	10.1	102	150	17				•
PDM 102	10.2							•
PDM 103	10.3							•

EDP. No.	Dia.	L ₁	L ₂	D ₂	STOCK
PDM 104	10.4	68	115	11	•
PDM 105	10.5				•
PDM 106	10.6				•
PDM 107	10.7				•
PDM 108	10.8				•
PDM 109	10.9				•
PDM 110	11.0				•
PDM 111	11.1	71	121	12	•
PDM 112	11.2				•
PDM 113	11.3				•
PDM 114	11.4				•
PDM 115	11.5				•
PDM 116	11.6				•
PDM 117	11.7				•
PDM 118	11.8				•
PDM 119	11.9				•
PDM 120	12.0				•
PDM 121	12.1	75	125	13	•
PDM 122	12.2				•
PDM 123	12.3				•
PDM 124	12.4				•
PDM 125	12.5				•
PDM 126	12.6				•
PDM 127	12.7				•
PDM 128	12.8				•
PDM 129	12.9				•
PDM 130	13.0				•
PDM 131	13.1	80	134	14	•
PDM 132	13.2				•
PDM 133	13.3				•
PDM 134	13.4				•
PDM 135	13.5				•
PDM 136	13.6				•
PDM 137	13.7				•
PDM 138	13.8				•
PDM 139	13.9				•
PDM 140	14.0				•

EDP. No.	Dia.	L ₁	L ₂	D ₂	STOCK			
PDM 141	14.1	83	143	15	•			
PDM 142	14.2				•			
PDM 143	14.3				•			
PDM 144	14.4				•			
PDM 145	14.5				•			
PDM 146	14.6				•			
PDM 147	14.7				•			
PDM 148	14.8				•			
PDM 149	14.9				•			
PDM 150	15.0				•			
PDM 151	15.1	90	152	16	•			
PDM 152	15.2				•			
PDM 154	15.4				•			
PDM 155	15.5				•			
PDM 156	15.6				•			
PDM 157	15.7				•			
PDM 158	15.8				•			
PDM 160	16.0				•			
PDM 161	16.1	95	155	17	•			
PDM 163	16.3				•			
PDM 165	16.5				•			
PDM 170	17.0				•			
PDM 171	17.1	100	157	18	•			
PDM 172	17.2				•			
PDM 175	17.5				•			
PDM 177	17.7				•			
PDM 178	17.8				•			
PDM 180	18.0				•			
PDM 181	18.1				105	160	19	•
PDM 182	18.2							•
PDM 185	18.5	•						
PDM 190	19.0	•						
PDM 191	19.1	110	163	20	•			
PDM 195	19.5				•			
PDM 197	19.7				•			
PDM 200	20.0				•			

■ Tolerance μm=1/1000mm

Tolerance \ Dia.	from 1 to 3	over 3 to 6	over 6 to 10	over 10 to 18	over 18 to 30
Cutting Edge(h8)	0 -14	0 -18	0 -22	0 -27	0 -33
Shank(h6)	0 -6	0 -8	0 -9	0 -11	0 -13

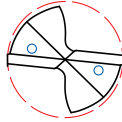
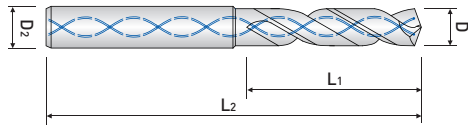

POWER DRILL - STUB
/ INTERNAL COOLANT / 3 x D

PDSI ...series



EDP. No.	Dia.	L1	L2	D2	STOCK
PDSI 030	3.0	18	60	3	•
PDSI 031	3.1	20		4	•
PDSI 032	3.2				•
PDSI 033	3.3				•
PDSI 034	3.4	22	4		•
PDSI 035	3.5			•	
PDSI 036	3.6			•	
PDSI 037	3.7			•	
PDSI 038	3.8	24	4	•	
PDSI 039	3.9			•	
PDSI 040	4.0			•	
PDSI 041	4.1			26	62
PDSI 042	4.2	•			
PDSI 043	4.3	•			
PDSI 044	4.4	•			
PDSI 045	4.5	•			
PDSI 046	4.6	•			
PDSI 047	4.7	•			
PDSI 048	4.8	•			
PDSI 049	4.9	•			
PDSI 050	5.0	•			
PDSI 051	5.1	28	66	6	•
PDSI 052	5.2				•
PDSI 053	5.3				•
PDSI 054	5.4				•
PDSI 055	5.5	30	66	6	•
PDSI 056	5.6				•
PDSI 057	5.7				•
PDSI 058	5.8				•
PDSI 059	5.9	34	74	7	•
PDSI 060	6.0				•
PDSI 061	6.1				•
PDSI 062	6.2				•
PDSI 063	6.3	34	74	7	•
PDSI 064	6.4				•
PDSI 065	6.5				•
PDSI 066	6.6				•

EDP. No.	Dia.	L1	L2	D2	STOCK
PDSI 067	6.7	37	74	7	•
PDSI 068	6.8				•
PDSI 069	6.9				•
PDSI 070	7.0				•
PDSI 071	7.1	40	79	8	•
PDSI 072	7.2				•
PDSI 073	7.3				•
PDSI 074	7.4				•
PDSI 075	7.5				•
PDSI 076	7.6				•
PDSI 077	7.7				•
PDSI 078	7.8				•
PDSI 079	7.9				•
PDSI 080	8.0				•
PDSI 081	8.1	43	84	9	•
PDSI 082	8.2				•
PDSI 083	8.3				•
PDSI 084	8.4				•
PDSI 085	8.5				•
PDSI 086	8.6				•
PDSI 087	8.7				•
PDSI 088	8.8				•
PDSI 089	8.9				•
PDSI 090	9.0				•
PDSI 091	9.1	47	89	10	•
PDSI 092	9.2				•
PDSI 093	9.3				•
PDSI 094	9.4				•
PDSI 095	9.5				•
PDSI 096	9.6				•
PDSI 097	9.7				•
PDSI 098	9.8				•
PDSI 099	9.9				•
PDSI 100	10.0				•
PDSI 101	10.1	51	95	11	•
PDSI 102	10.2				•
PDSI 103	10.3				•

EDP. No.	Dia.	L ₁	L ₂	D ₂	STOCK
PDSI 104	10.4	51	95	11	•
PDSI 105	10.5				•
PDSI 106	10.6				•
PDSI 107	10.7				•
PDSI 108	10.8				•
PDSI 109	10.9				•
PDSI 110	11.0				•
PDSI 111	11.1	54	102	12	•
PDSI 112	11.2				•
PDSI 113	11.3				•
PDSI 114	11.4				•
PDSI 115	11.5				•
PDSI 116	11.6				•
PDSI 117	11.7				•
PDSI 118	11.8				•
PDSI 119	11.9				•
PDSI 120	12.0				•
PDSI 121	12.1	57	102	13	•
PDSI 122	12.2				•
PDSI 123	12.3				•
PDSI 124	12.4				•
PDSI 125	12.5				•
PDSI 126	12.6				•
PDSI 127	12.7				•
PDSI 128	12.8				•
PDSI 129	12.9				•
PDSI 130	13.0				•
PDSI 131	13.1	60	107	14	•
PDSI 132	13.2				•
PDSI 133	13.3				•
PDSI 134	13.4				•
PDSI 135	13.5				•
PDSI 136	13.6				•
PDSI 137	13.7				•
PDSI 138	13.8				•
PDSI 139	13.9				•
PDSI 140	14.0				•

EDP. No.	Dia.	L ₁	L ₂	D ₂	STOCK			
PDSI 141	14.1	62	111	15	•			
PDSI 142	14.2				•			
PDSI 143	14.3				•			
PDSI 144	14.4				•			
PDSI 145	14.5				•			
PDSI 146	14.6				•			
PDSI 147	14.7				•			
PDSI 148	14.8				•			
PDSI 149	14.9				•			
PDSI 150	15.0				•			
PDSI 151	15.1	64	115	16	•			
PDSI 152	15.2				•			
PDSI 154	15.4				•			
PDSI 155	15.5				•			
PDSI 156	15.6				•			
PDSI 157	15.7				•			
PDSI 158	15.8				•			
PDSI 160	16.0				•			
PDSI 161	16.1	66	119	17	•			
PDSI 163	16.3				•			
PDSI 165	16.5				•			
PDSI 170	17.0				•			
PDSI 171	17.1	66	123	18	•			
PDSI 172	17.2				•			
PDSI 175	17.5				•			
PDSI 177	17.7				•			
PDSI 178	17.8				•			
PDSI 180	18.0				•			
PDSI 181	18.1				70	127	19	•
PDSI 182	18.2							•
PDSI 185	18.5	•						
PDSI 190	19.0	•						
PDSI 191	19.1	70	131	20	•			
PDSI 195	19.5				•			
PDSI 197	19.7				•			
PDSI 200	20.0				•			

■ Tolerance μm=1/1000mm

Tolerance \ Dia.	from 1 to 3	over 3 to 6	over 6 to 10	over 10 to 18	over 18 to 30
Cutting Edge(h8)	0 -14	0 -18	0 -22	0 -27	0 -33
Shank(h6)	0 -6	0 -8	0 -9	0 -11	0 -13

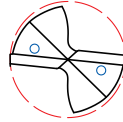
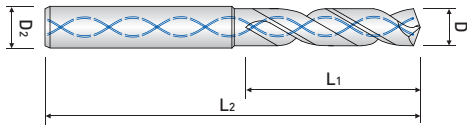

POWER DRILL - MEDIUM
/ INTERNAL COOLANT / 5 x D

PDMI ...series



EDP. No.	Dia.	L1	L2	D2	STOCK
PDMI 031	3.1	27	74	4	•
PDMI 032	3.2				•
PDMI 033	3.3				•
PDMI 034	3.4				•
PDMI 035	3.5				•
PDMI 036	3.6				•
PDMI 037	3.7				•
PDMI 038	3.8	33			•
PDMI 039	3.9				•
PDMI 040	4.0				•
PDMI 041	4.1	33			•
PDMI 042	4.2				•
PDMI 043	4.3	36	80	5	•
PDMI 044	4.4				•
PDMI 045	4.5				•
PDMI 046	4.6				•
PDMI 047	4.7				•
PDMI 048	4.8				•
PDMI 049	4.9				39
PDMI 050	5.0	•			
PDMI 051	5.1	39			•
PDMI 052	5.2				•
PDMI 053	5.3				•
PDMI 054	5.4	43	87	6	•
PDMI 055	5.5				•
PDMI 056	5.6				•
PDMI 057	5.7				•
PDMI 058	5.8				•
PDMI 059	5.9				•
PDMI 060	6.0				•
PDMI 061	6.1	47	95	7	•
PDMI 062	6.2				•
PDMI 063	6.3				•
PDMI 064	6.4				•
PDMI 065	6.5				•
PDMI 066	6.6				•
PDMI 067	6.7				•

EDP. No.	Dia.	L1	L2	D2	STOCK
PDMI 068	6.8	47	95	7	•
PDMI 069	6.9				•
PDMI 070	7.0				•
PDMI 071	7.1	52	103	8	•
PDMI 072	7.2				•
PDMI 073	7.3				•
PDMI 074	7.4				•
PDMI 075	7.5				•
PDMI 076	7.6				•
PDMI 077	7.7				•
PDMI 078	7.8				•
PDMI 079	7.9				•
PDMI 080	8.0				•
PDMI 081	8.1	56	105	9	•
PDMI 082	8.2				•
PDMI 083	8.3				•
PDMI 084	8.4				•
PDMI 085	8.5				•
PDMI 086	8.6				•
PDMI 087	8.7				•
PDMI 088	8.8				•
PDMI 089	8.9				•
PDMI 090	9.0				•
PDMI 091	9.1	62	108	10	•
PDMI 092	9.2				•
PDMI 093	9.3				•
PDMI 094	9.4				•
PDMI 095	9.5				•
PDMI 096	9.6				•
PDMI 097	9.7				•
PDMI 098	9.8				•
PDMI 099	9.9				•
PDMI 100	10.0				•
PDMI 101	10.1	68	125	11	•
PDMI 102	10.2				•
PDMI 103	10.3				•
PDMI 104	10.4				•

EDP. No.	Dia.	L ₁	L ₂	D ₂	STOCK
PDMI 105	10.5	68	125	11	•
PDMI 106	10.6				•
PDMI 107	10.7				•
PDMI 108	10.8				•
PDMI 109	10.9				•
PDMI 110	11.0				•
PDMI 111	11.1	71	133	12	•
PDMI 112	11.2				•
PDMI 113	11.3				•
PDMI 114	11.4				•
PDMI 115	11.5				•
PDMI 116	11.6				•
PDMI 117	11.7				•
PDMI 118	11.8				•
PDMI 119	11.9				•
PDMI 120	12.0				•
PDMI 121	12.1	75	137	13	•
PDMI 122	12.2				•
PDMI 123	12.3				•
PDMI 124	12.4				•
PDMI 125	12.5				•
PDMI 126	12.6				•
PDMI 127	12.7				•
PDMI 128	12.8				•
PDMI 129	12.9				•
PDMI 130	13.0				•
PDMI 131	13.1	80	142	14	•
PDMI 132	13.2				•
PDMI 133	13.3				•
PDMI 134	13.4				•
PDMI 135	13.5				•
PDMI 136	13.6				•
PDMI 137	13.7				•
PDMI 138	13.8				•
PDMI 139	13.9				•
PDMI 140	14.0				•

EDP. No.	Dia.	L ₁	L ₂	D ₂	STOCK			
PDMI 141	14.1	83	148	15	•			
PDMI 142	14.2				•			
PDMI 143	14.3				•			
PDMI 144	14.4				•			
PDMI 145	14.5				•			
PDMI 146	14.6				•			
PDMI 147	14.7				•			
PDMI 148	14.8				•			
PDMI 149	14.9				•			
PDMI 150	15.0				•			
PDMI 151	15.1	90	152	16	•			
PDMI 152	15.2				•			
PDMI 154	15.4				•			
PDMI 155	15.5				•			
PDMI 156	15.6				•			
PDMI 157	15.7				•			
PDMI 158	15.8				•			
PDMI 160	16.0	•						
PDMI 161	16.1	95	155	17	•			
PDMI 163	16.3				•			
PDMI 165	16.5				•			
PDMI 170	17.0				•			
PDMI 171	17.1	100	157	18	•			
PDMI 172	17.2				•			
PDMI 175	17.5				•			
PDMI 177	17.7				•			
PDMI 178	17.8				•			
PDMI 180	18.0				•			
PDMI 181	18.1				105	160	19	•
PDMI 182	18.2							•
PDMI 185	18.5	•						
PDMI 190	19.0	•						
PDMI 191	19.1	110	163	20	•			
PDMI 195	19.5				•			
PDMI 197	19.7				•			
PDMI 200	20.0				•			

■ Tolerance μm=1/1000mm

Tolerance \ Dia.	from 1 to 3	over 3 to 6	over 6 to 10	over 10 to 18	over 18 to 30
Cutting Edge(h8)	0 -14	0 -18	0 -22	0 -27	0 -33
Shank(h6)	0 -6	0 -8	0 -9	0 -11	0 -13

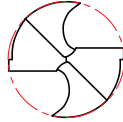
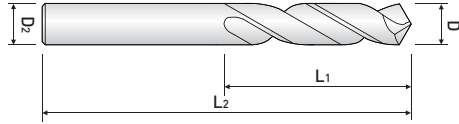

SOLID SPIRAL DRILL

SSD ...series

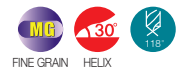

EDP. No.	Dia.	L1	L2	STOCK
SSD010	1.0	10	38	•
SSD011	1.1			•
SSD012	1.2			•
SSD013	1.3			•
SSD014	1.4			•
SSD015	1.5	13	38	•
SSD016	1.6			•
SSD017	1.7			•
SSD018	1.8			•
SSD019	1.9			•
SSD020	2.0	16	45	•
SSD021	2.1			•
SSD022	2.2			•
SSD023	2.3			•
SSD024	2.4			•
SSD025	2.5	20	50	•
SSD026	2.6			•
SSD027	2.7	22	50	•
SSD028	2.8			•
SSD029	2.9			•
SSD030	3.0			•
SSD031	3.1	25	50	•
SSD032	3.2			•
SSD033	3.3			•
SSD034	3.4			•
SSD035	3.5			•

EDP. No.	Dia.	L1	L2	STOCK
SSD036	3.6	28	55	•
SSD037	3.7			•
SSD038	3.8			•
SSD039	3.9			•
SSD040	4.0			•
SSD041	4.1	30	60	•
SSD042	4.2			•
SSD043	4.3			•
SSD044	4.4			•
SSD045	4.5			•
SSD046	4.6	33	65	•
SSD047	4.7			•
SSD048	4.8	35	65	•
SSD049	4.9			•
SSD050	5.0			•
SSD051	5.1			•
SSD052	5.2			•
SSD053	5.3			•
SSD054	5.4			•
SSD055	5.5			•
SSD056	5.6	38	75	•
SSD057	5.7			•
SSD058	5.8			•
SSD059	5.9			•
SSD060	6.0			•

EDP. No.	Dia.	L ₁	L ₂	STOCK
SSD061	6.1	38	75	•
SSD062	6.2			•
SSD063	6.3			•
SSD064	6.4			•
SSD065	6.5			•
SSD066	6.6	45	80	•
SSD067	6.7			•
SSD068	6.8			•
SSD069	6.9			•
SSD070	7.0			•
SSD071	7.1			•
SSD072	7.2			•
SSD073	7.3			•
SSD074	7.4			•
SSD075	7.5			•
SSD076	7.6	50	85	•
SSD077	7.7			•
SSD078	7.8			•
SSD079	7.9			•
SSD080	8.0			•
SSD081	8.1			•
SSD082	8.2			•
SSD083	8.3			•
SSD084	8.4			•
SSD085	8.5			•
SSD086	8.6	50	95	•
SSD087	8.7			•
SSD088	8.8			•
SSD089	8.9			•
SSD090	9.0			•

EDP. No.	Dia.	L ₁	L ₂	STOCK		
SSD091	9.1	50	95	•		
SSD092	9.2			•		
SSD093	9.3			•		
SSD094	9.4			•		
SSD095	9.5			•		
SSD096	9.6			•		
SSD097	9.7			•		
SSD098	9.8			•		
SSD099	9.9	55	100	•		
SSD100	10.0			•		
SSD101	10.1	55	115	•		
SSD102	10.2			•		
SSD103	10.3			•		
SSD104	10.4			•		
SSD105	10.5			•		
SSD106	10.6	60	115	•		
SSD107	10.7			•		
SSD108	10.8			•		
SSD109	10.9			•		
SSD110	11.0			•		
SSD111	11.1	65	120	•		
SSD112	11.2			•		
SSD113	11.3			•		
SSD115	11.5			•		
SSD118	11.8			•		
SSD119	11.9			•		
SSD120	12.0			•		
SSD124	12.4			70	125	•
SSD125	12.5					•
SSD130	13.0			75	130	•

■ Tolerance μm=1/1000mm

Tolerance \ Dia.	from 1 to 3	over 3 to 6	over 6 to 10	over 10 to 18
Cutting Edge(h8)	0 -14	0 -18	0 -22	0 -27
Shank(h6)	0 -10	0 -12	0 -15	0 -18



SOLID SPIRAL DRILL - LONG

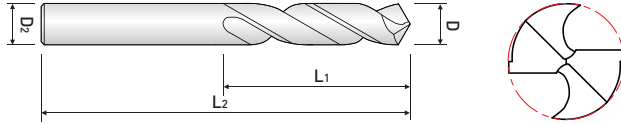

SSDL ...series



EDP. No.	Dia.	L1	L2	STOCK
SSDL030	3.0	42	73	•
SSDL031	3.1			•
SSDL032	3.2			•
SSDL033	3.3			•
SSDL034	3.4			•
SSDL035	3.5			•
SSDL036	3.6	45	80	•
SSDL037	3.7			•
SSDL038	3.8	48	80	•
SSDL039	3.9	50	80	•
SSDL040	4.0	54	85	•
SSDL041	4.1			•
SSDL042	4.2			•
SSDL043	4.3			•
SSDL044	4.4			•
SSDL045	4.5			•
SSDL046	4.6	59	90	•
SSDL047	4.7			•
SSDL048	4.8			•
SSDL049	4.9			•
SSDL050	5.0			•
SSDL051	5.1	63	95	•
SSDL052	5.2			•
SSDL053	5.3			•
SSDL054	5.4			•
SSDL055	5.5			•
SSDL056	5.6	66	100	•
SSDL057	5.7			•
SSDL058	5.8			•
SSDL059	5.9			•
SSDL060	6.0	70	105	•
SSDL061	6.1			•
SSDL062	6.2			•
SSDL063	6.3			•
SSDL064	6.4			•
SSDL065	6.5			•

EDP. No.	Dia.	L1	L2	STOCK
SSDL066	6.6	73	105	•
SSDL067	6.7			•
SSDL068	6.8			•
SSDL069	6.9			•
SSDL070	7.0			•
SSDL071	7.1	76	110	•
SSDL072	7.2			•
SSDL073	7.3			•
SSDL074	7.4			•
SSDL075	7.5			•
SSDL076	7.6	80	115	•
SSDL077	7.7			•
SSDL078	7.8			•
SSDL079	7.9			•
SSDL080	8.0			•
SSDL081	8.1	85	125	•
SSDL082	8.2			•
SSDL083	8.3			•
SSDL084	8.4			•
SSDL085	8.5			•
SSDL086	8.6			•
SSDL087	8.7			•
SSDL088	8.8			•
SSDL089	8.9			•
SSDL090	9.0	•		
SSDL091	9.1	88	130	•
SSDL092	9.2			•
SSDL093	9.3			•
SSDL094	9.4			•
SSDL095	9.5			•
SSDL096	9.6	90	130	•
SSDL097	9.7			•
SSDL098	9.8			•
SSDL099	9.9			•
SSDL100	10.0			•

Tolerance		mm = 1/1000mm			
Tolerance	Dia.	from 1 to 3	over 3 to 6	over 6 to 10	over 10 to 18
Cutting Edge(h8)		0 -14	0 -18	0 -22	0 -27
Shank(h6)		0 -10	0 -12	0 -15	0 -18

□ Nomenclature of Drill

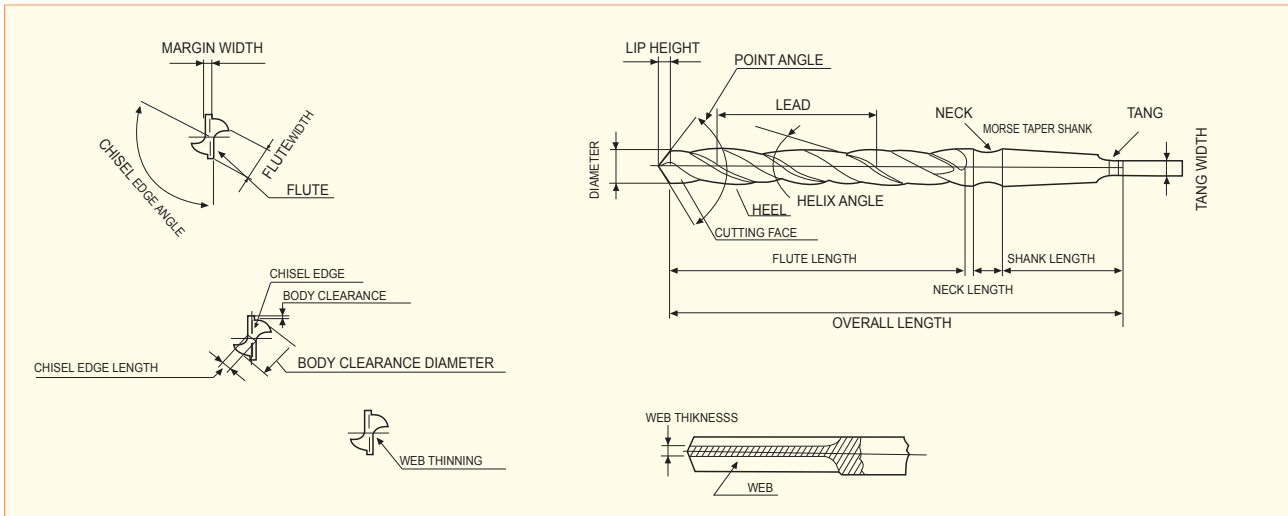

□ Working of Main Angle

POINT ANGLE	HELIX ANGLE	LIP RELIEF ANGLE
70° 118° 140°	10° 38° 40°	7° 10° 12° 15°
Large → Torque → Small Small → Thrust → Large	Bad → Cutting Capacity → Good Good → Chip Ejection → Bad Large → Rigidity of tool → Small	Small → Tool Wear → Large Small → Vibration → Large

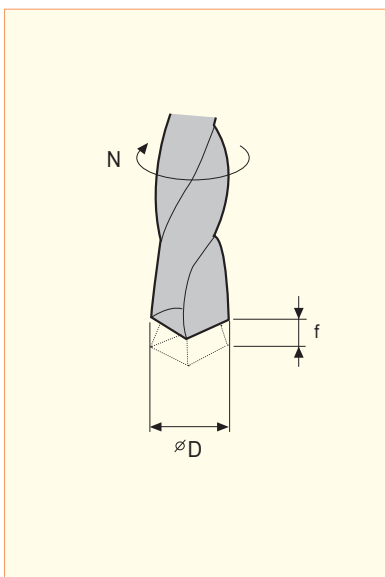

●Cutting Speed

$$V = \frac{\pi \times D \times N}{1000} \text{ (m/min)}$$

- V : cutting Speed (m/min)
- D : Diameter of drill (mm)
- N : revolution (rpm)
- π : (3.14)

●Feed

$$f = \frac{S}{N} \text{ (m/rev)}$$

- f : feed (mm/rev)
- S : depth of cut per min (mm/min)
- N : revolution(rpm) (rpm)

●Helix Angle

$$\delta = \tan^{-1} \left(\frac{\pi D}{L} \right)$$

- δ : helix angle
- D : Diameter of drill (mm)
- L : lead (mm)
- π : (3.14)

SSD series

Work Material	ToolSteels, AlloySteels SKD, SCM		Aluminum Rolled, Aluminum Alloy AL, AC		Brass, Bronze Bs, PB		Epoxy, Resin	
	DIAMETER (mm)	RPM (mm ⁻¹)	FEED (mm/rev)	RPM (mm ⁻¹)	FEED (mm/rev)	RPM (mm ⁻¹)	FEED (mm/rev)	RPM (mm ⁻¹)
3	4000~7000	0.02	10000~12000	0.03	7000~10000	0.02	9000~12000	0.08
5	2400~4200	0.03	6000~8000	0.05	4200~6000	0.04	5400~7200	0.08
8	1500~2600	0.05	3700~5000	0.08	2600~3700	0.08	3400~4500	0.09
12	1000~1700	0.06	2500~3200	0.12	1700~2500	0.12	2200~3000	0.11

PDS, PDM series ▶ Power Drill

V : m/min, f : mm/rev

MATERIAL			MILD STEEL-ALLOY STEEL-CARBON STEEL		ALLOY STEEL FORGED STEEL		HIGH HARDENED STEELS		STAINLESS STEEL		DUCTILE CAST IRON		CAST IRON	
			≤HRc 25		HRc 25~ HRc 35		HRc 35~ HRc 45							
TYPE	Dia.	COD	V	f	V	f	V	f	V	f	V	f	V	f
SOLID TYPE	ø3-5	PDS030-050	40~70	0.15-0.25	35~55	0.10-0.20	15~25	0.05-0.15	15~25	0.05-0.15	35~70	0.15-0.25	45~75	0.15-0.30
	ø5-8	PDS051-080	50~75	0.20-0.30	45~60	0.15-0.25	15~30	0.10-0.20	15~30	0.10-0.20	45~75	0.20-0.35	55~85	0.20-0.40
	ø8-10	PDS081-100	50~75	0.25-0.35	45~60	0.15-0.30	20~35	0.10-0.20	15~30	0.10-0.20	45~75	0.25-0.40	55~85	0.20-0.40
	ø10-12	PDS101-120	50~75	0.25-0.35	45~60	0.15-0.30	20~35	0.10-0.25	15~30	0.10-0.25	45~75	0.25-0.40	55~85	0.20-0.45
	ø12-14	PDS121-140	55~80	0.25-0.40	50~70	0.20-0.35	20~35	0.10-0.25	15~30	0.10-0.25	50~80	0.25-0.45	60~90	0.25-0.50
	ø14-20	PDS141-200	55~80	0.30-0.45	50~70	0.20-0.35	20~35	0.10-0.30	15~30	0.10-0.25	50~80	0.25-0.50	60~100	0.25-0.55

PDSI, PDMI series ▶ Oil Hole Power Drill

V : m/min, f : mm/rev

MATERIAL		MILD STEEL-ALLOY STEEL-CARBON STEEL		ALLOY STEEL FORGED STEEL		HIGH HARDENED STEELS		STAINLESS STEEL		DUCTILE CAST IRON		CAST IRON	
		≤HRc 25		HRc 25~ HRc 35		HRc 35~ HRc 45							
Dia.		V	f	V	f	V	f	V	f	V	f	V	f
7~8		80~110	0.15-0.25	70~100	0.15-0.25	50~80	0.10-0.20	30~60	0.10-0.20	50~80	0.15-0.25	80~120	0.15-0.30
8~10		90~120	0.20-0.30	80~110	0.15-0.30	60~90	0.15-0.25	30~70	0.10-0.20	60~90	0.20-0.30	100~130	0.25-0.35
10~12		100~130	0.25-0.35	90~120	0.20-0.30	70~100	0.20-0.30	30~70	0.10-0.20	70~100	0.25-0.35	110~140	0.25-0.35
12~16		110~140	0.25-0.35	100~130	0.25-0.35	80~100	0.20-0.30	40~70	0.15-0.25	80~110	0.30-0.40	120~150	0.30-0.40
16~20		120~150	0.25-0.40	110~140	0.25-0.35	90~110	0.20-0.30	40~70	0.15-0.30	90~120	0.30-0.40	130~160	0.30-0.40

PF50, P50 series

MATERIAL	CARBON STEEL(C<0.3%) ALLOY STEEL/SS400 SCM ~710N/mm ²		CARBON STEEL(C≥0.3%) ALLOY STEEL/S50C SCM ~1.060N/mm ²		SUJ2-SUS440		SKD61 34-43 HRC		43-48 HRC		SKD11 48-53 HRC		CAST IRON FC 250-350		DUCTILE FC 400-500	
V	80~125m/min		80~125m/min		63~80m/min		40~63m/min		32~45m/min		25~36m/min		80~125m/min		63~90m/min	
DIAMETER (mm)	RPM (mm ⁻¹)	FEED (mm/rev)	RPM (mm ⁻¹)	FEED (mm/rev)	RPM (mm ⁻¹)	FEED (mm/rev)	RPM (mm ⁻¹)	FEED (mm/rev)	RPM (mm ⁻¹)	FEED (mm/rev)	RPM (mm ⁻¹)	FEED (mm/rev)	RPM (mm ⁻¹)	FEED (mm/rev)	RPM (mm ⁻¹)	FEED (mm/rev)
2	12,000	0.06-0.08	12,000	0.06-0.08	11,000	0.06-0.08	8,000	0.06-0.08	6,000	0.05-0.07	4,500	0.03-0.06	15,000	0.06-0.08	11,000	0.06-0.08
3	9,600	0.09-0.12	9,600	0.09-0.12	7,500	0.09-0.12	5,300	0.09-0.12	4,000	0.07-0.11	3,200	0.05-0.09	10,000	0.09-0.12	7,600	0.09-0.12
4	8,000	0.10-0.15	8,000	0.10-0.15	5,650	0.10-0.15	4,000	0.10-0.15	3,000	0.08-0.13	2,600	0.06-0.10	8,000	0.10-0.15	6,000	0.10-0.15
5	6,400	0.12-0.18	6,400	0.12-0.18	4,550	0.12-0.18	3,300	0.12-0.18	2,400	0.10-0.15	2,000	0.8-0.12	6,400	0.12-0.18	4,800	0.12-0.18
6	5,300	0.14-0.20	5,300	0.14-0.20	3,800	0.14-0.20	2,750	0.14-0.20	2,000	0.12-0.18	1,700	0.09-0.15	5,300	0.14-0.20	4,000	0.14-0.20
8	4,000	0.16-0.24	4,000	0.16-0.24	2,850	0.16-0.24	2,100	0.16-0.24	1,500	0.14-0.22	1,300	0.12-0.20	4,000	0.16-0.24	3,000	0.16-0.24
10	3,200	0.18-0.27	3,200	0.18-0.27	2,250	0.18-0.27	1,700	0.18-0.27	1,200	0.15-0.25	1,000	0.13-0.23	3,200	0.18-0.27	2,400	0.18-0.27
12	2,650	0.20-0.30	2,650	0.20-0.30	1,900	0.20-0.30	1,400	0.20-0.30	1,000	0.17-0.26	850	0.14-0.24	2,700	0.20-0.30	2,000	0.20-0.30
14	2,300	0.22-0.35	2,300	0.22-0.35	1,600	0.22-0.35	1,200	0.22-0.35	860	0.18-0.30	730	0.15-0.26	2,300	0.22-0.35	1,700	0.22-0.35
16	2,000	0.25-0.36	2,000	0.25-0.36	1,400	0.25-0.36	1,050	0.25-0.36	760	0.20-0.32	640	0.16-0.26	2,000	0.25-0.36	1,500	0.25-0.36
18	1,800	0.28-0.38	1,800	0.28-0.38	1,250	0.28-0.38	920	0.28-0.38	670	0.23-0.33	570	0.18-0.28	1,800	0.28-0.38	1,350	0.28-0.38
20	1,600	0.30-0.40	1,600	0.30-0.40	1,150	0.30-0.40	850	0.30-0.40	600	0.25-0.35	500	0.20-0.30	1,600	0.30-0.40	1,200	0.30-0.40

SF50, PI50 series

MATERIAL	CARBON STEEL(C<0.3%) ALLOY STEEL/SS400 SCM ~710N/mm ²		CARBON STEEL(C≥0.3%) ALLOY STEEL/S50C SCM ~1.060N/mm ²		SUJ2-SUS440		SKD61 34-43 HRC		43-48 HRC		SKD11 48-53 HRC		CAST IRON FC 250-350		DUCTILE FC 400-500	
V	80~150m/min		80~150m/min		63~100m/min		40~70m/min		32~50m/min		25~40m/min		80~150m/min		63~100m/min	
DIAMETER (mm)	RPM (mm ⁻¹)	FEED (mm/rev)	RPM (mm ⁻¹)	FEED (mm/rev)	RPM (mm ⁻¹)	FEED (mm/rev)	RPM (mm ⁻¹)	FEED (mm/rev)	RPM (mm ⁻¹)	FEED (mm/rev)	RPM (mm ⁻¹)	FEED (mm/rev)	RPM (mm ⁻¹)	FEED (mm/rev)	RPM (mm ⁻¹)	FEED (mm/rev)
3	12,000	0.09-0.12	13,000	0.09-0.12	7,600	0.09-0.12	6,400	0.09-0.12	5,300	0.07-0.11	3,800	0.05-0.09	12,000	0.09-0.12	8,500	0.09-0.12
4	9,500	0.10-0.15	10,000	0.10-0.15	5,700	0.10-0.15	4,800	0.10-0.15	4,000	0.08-0.13	2,950	0.06-0.10	9,000	0.10-0.15	6,350	0.10-0.15
5	7,600	0.12-0.18	8,000	0.12-0.18	4,600	0.12-0.18	3,800	0.12-0.18	3,200	0.10-0.15	2,300	0.8-0.12	7,600	0.12-0.18	5,100	0.12-0.18
6	6,400	0.14-0.20	6,600	0.14-0.20	3,800	0.14-0.20	3,200	0.14-0.20	2,650	0.12-0.18	1,900	0.09-0.15	6,400	0.14-0.20	4,250	0.14-0.20
8	4,800	0.16-0.24	5,000	0.16-0.24	2,900	0.16-0.24	2,400	0.16-0.24	2,000	0.14-0.22	1,450	0.12-0.20	4,800	0.16-0.24	3,200	0.16-0.24
10	3,800	0.18-0.27	4,000	0.18-0.27	2,300	0.18-0.27	1,900	0.18-0.27	1,600	0.15-0.25	1,150	0.13-0.23	3,800	0.18-0.27	2,550	0.18-0.27
12	3,200	0.20-0.30	3,300	0.20-0.30	1,900	0.20-0.30	1,600	0.20-0.30	1,300	0.17-0.26	950	0.14-0.24	3,200	0.20-0.30	2,100	0.20-0.30
14	2,700	0.22-0.35	2,800	0.22-0.35	1,600	0.22-0.35	1,350	0.22-0.35	1,150	0.18-0.30	800	0.15-0.26	2,700	0.22-0.35	1,800	0.22-0.35
16	2,400	0.25-0.36	2,500	0.25-0.36	1,400	0.25-0.36	1,200	0.25-0.36	1,000	0.20-0.32	700	0.16-0.26	2,400	0.25-0.36	1,600	0.25-0.36
18	2,100	0.28-0.38	2,200	0.28-0.38	1,300	0.28-0.38	1,100	0.28-0.38	900	0.23-0.33	650	0.18-0.28	2,100	0.28-0.38	1,400	0.28-0.38
20	1,900	0.30-0.40	2,000	0.30-0.40	1,150	0.30-0.40	1,000	0.30-0.40	800	0.25-0.35	600	0.20-0.30	1,900	0.30-0.40	1,250	0.30-0.40

□ SF51, SF52 series

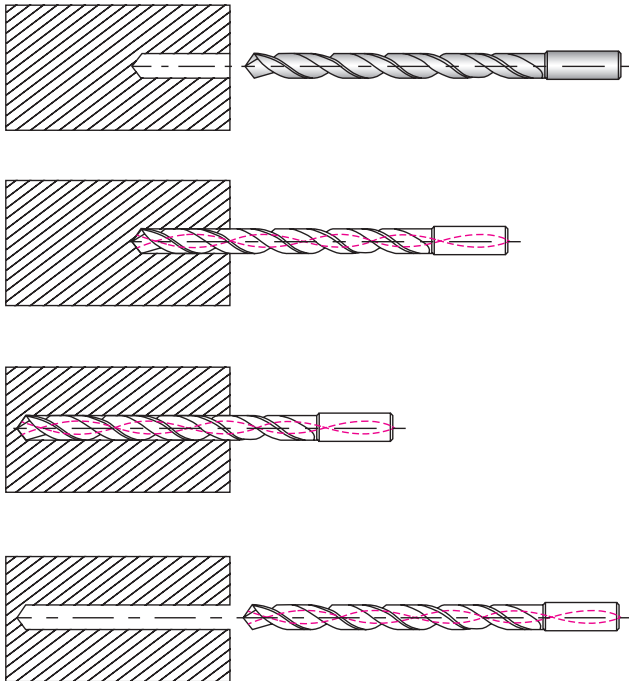

1. Guide Drilling should be done as Diameter+0.1mm between 3×D and 5×D
2. For Main Drilling, proceed with low RPM at Guide Drilling segment.
(RPM 300, FEED 400mm/min)
3. Just before the end of Guide Drilling segment, reduce feed to zero and increase the RPM according to Recommended Cutting Condition chart (See Below)
4. After then, proceed main drilling by increasing feed without step drilling.
5. When coming out from Guide Drilling start point after drilling, RPM should be reduced as 300 and feed should be 1000 mm/min.
6. When coming out from Guide Drilling segment to the outside, the feed should be decreased as 50%

WORK MATERIAL	CARBON STEELS ALLOY STEEL ~1060 N/mm ²		CAST IRON 250~350 N/mm ²		DUCTILE CAST IRON 400~500 N/mm ²	
	63~125 m/min		63~125 m/min		60~80 m/min	
Drilling Diameter	Speed (min ⁻¹)	Feed Rate (mm/rev)	Speed (min ⁻¹)	Feed Rate (mm/rev)	Speed (min ⁻¹)	Feed Rate (mm/rev)
3	7500	0.06 ~ 0.12	7500	0.06 ~ 0.12	7500	0.06 ~ 0.12
4	6400	0.08 ~ 0.16	6400	0.08 ~ 0.16	5600	0.08 ~ 0.16
5	5800	0.10 ~ 0.20	5800	0.10 ~ 0.20	4500	0.10 ~ 0.20
6	4800	0.12 ~ 0.24	4800	0.12 ~ 0.24	3800	0.12 ~ 0.24
8	3600	0.16 ~ 0.28	3600	0.16 ~ 0.28	2800	0.16 ~ 0.28
10	2900	0.20 ~ 0.35	2900	0.20 ~ 0.35	2300	0.20 ~ 0.35
12	2900	0.24 ~ 0.42	2400	0.24 ~ 0.42	1900	0.24 ~ 0.42
14	2050	0.28 ~ 0.46	2050	0.28 ~ 0.46	1600	0.28 ~ 0.46

N = R.P.M
S = Feed per Revolution(mm/rev)

Problems	Cause	Cutting Conditions					Tool shape					Grade		The Others				
		Cutting Speed	Feed Rate	Step Feed	Initial Feed	Cutting Fluid	Relief Angel	Point Angel	Thinning Angel	Honing	Change the rate of flute and land width	Thinning	Toughness	Hardness	Mechanical rigidity of machine	Drill Rigidity	Guide - Bush	Improvement of setting type
Chipping	• Improper cutting edge						▼		▼	▲			▲					
	• Improper cutting speed	▼				○												
	• Generation of built - up edge					○	▼		▼	▲			▲					
	• Generation of chattering and vibration	▼												▲	▲			○
Excessive wear on cutting edge	• Cutting speed too high in relation to insert grade	▼				○	▲	▲					▲					
Breakage	• Poor surface conditions of workpiece			○	▼												○	
	In the beginning of operating • Insufficient rigidity of tool and workpiece													▲				○
	• Deflection of hole	▼	▼															
Under the operating	• Default of chip ejection		▼	○								○						

▲ : Increase

▼ : Decrease

○ : Application

● : Proper application



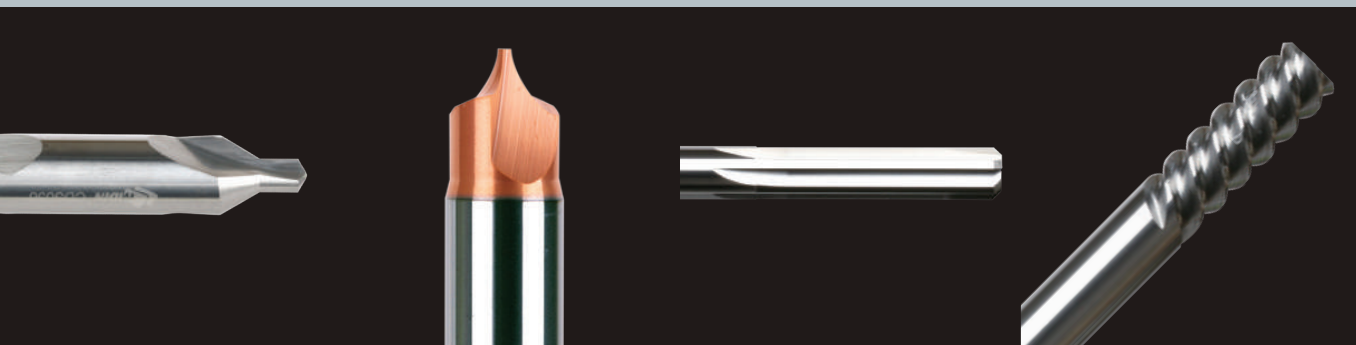

SOLID STANDARD







}	Centering Tools	368
	General Purpose	
	Reamers	375
	General Purpose	
	Technical Data	378

CENTERING TOOLS SERIES METRIC SIZE

Class	Feature	Type	Appearance	No. of Teeth	Item	App.	EDP. No.	Page
CENTERING TOOLS	Multi-Purpose				Center Drill Solid		CDS	370
				2FLUTE	NC Spotting Drill - 90°, 120°		LDS	371
				2FLUTE	Centering End Mill Solid - 90°		CES302	372
				2FLUTE	Centering End Mill Brazed Type - 90°		CEM	373
					CORNER ROUNDING CUTTER		CRC	374

CENTERING TOOLS SERIES METRIC SIZE

Class	Feature	Type	Appearance	No. of Teeth	Item	App.	EDP. No.	Page
REAMERS	Multi-Purpose	Straight		4&6FLUTE	Straight Flute Reamers		SSR	375
		7° Left Helix		4&6FLUTE	Helical Flute Reamers		SHR	376
		60° Left Helix		4&6FLUTE	Broach Reamers		SBR	377



	Carbon Steels (S45C,S55C...) ~ HB225	Alloy Steels (SCM,SK...) HB225~325	Prehardened Steels(NAK...) HRC30~50	Hardened Steels		Copper	Graphite	Cast Iron FCD400.500~	Aluminum	Stainless Steels
				~HRC55 SKD61	HRC55~ SKD11					
	○	○							○	
	○	○	○					○		
	○	○							○	







	Carbon Steels (S45C,S55C...) ~ HB225	Alloy Steels (SCM,SK...) HB225~325	Prehardened Steels(NAK...) HRC30~50	Hardened Steels		Copper	Graphite	Cast Iron FCD400.500~	Aluminum	Stainless Steels
				~HRC55 SKD61	HRC55~ SKD11					
	○	○								

Solid Standard Series





Centering Tools



EDP. No.	APPEARANCE	FEATURE	STOCK	PAGE
CDS ...series		SOLID CENTER DRILL	•	370
LDS ...series		NC SPOTTING DRILL	•	371
CES302 ...series		CENTERING END MILL - SOLID	•	372
CEM ...series		CENTERING END MILL - BRAZED TYPE	•	373
CRC ...series		CORNER ROUNDING CUTTER	•	374

Reamers



EDP. No.	APPEARANCE	FEATURE	STOCK	PAGE
SSR ...series		STRAIGHT FLUTE REAMERS	•	375
SHR ...series		HELICAL FLUTE REAMERS	•	376
SBR ...series		BROACH REAMERS	•	377



SOLID CENTER DRILL

CDS ...series



EDP. No.	Dia.	F.L	OAL	SH.Dia.	STOCK
CDS010	1	1	40	3	•
CDS015	1.5	1.5	40	4	•
CDS020	2	2	45	5	•
CDS025	2.5	2.5	45	6	•
CDS030	3	3	55	8	•
CDS040	4	4.5	60	10	•
CDS050	5	5.5	65	12	•



NC SPOTTING DRILL

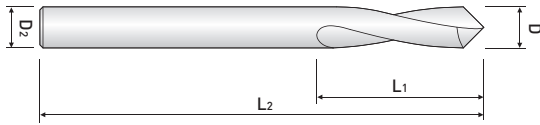

LDS ...series



EDP. No.	Dia.	L ₁	L ₂	D ₂	Point Angle	STOCK
LDS030	3	9	50	3	90°	•
LDS030A					120°	•
LDS040	4	10	50	4	90°	•
LDS040A					120°	•
LDS050	5	12	50	5	90°	•
LDS050A					120°	•
LDS060	6	13	60	6	90°	•
LDS060A					120°	•
LDS080	8	23	70	8	90°	•
LDS080A					120°	•
LDS100	10	24	80	10	90°	•
LDS100A					120°	•
LDS120	12	28	80	12	90°	•
LDS120A					120°	•
LDS160	16	32	90	16	90°	•
LDS160A					120°	•
LDS200	20	35	100	20	90°	•
LDS200A					120°	•

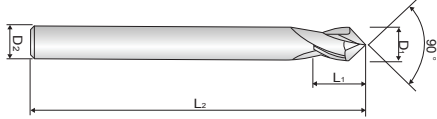

CENTERING END MILL - SOLID

CES302 ...series



EDP. No.	D ₁	L ₁	L ₂	D ₂	STOCK
CES302030	3	6	50	6	•
CES302040	4	8	50	6	•
CES302050	5	10	50	6	•
CES302060	6	12	60	6	•
CES302080	8	16	70	8	•
CES302100	10	18	70	10	•
CES302120	12	20	75	12	•
CES302140	14	24	80	14	•
CES302160	16	26	80	16	•
CES302200	20	32	100	20	•

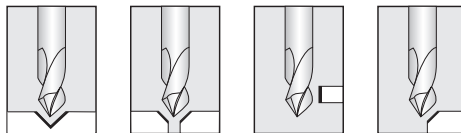

■ Tolerance

Mill Dia. (mm)	Shank Dia.
0 ~ -0,05	h6

※Items can be changed for quality improvement without notice.



CENTERING END MILL
- BRAZED TYPE

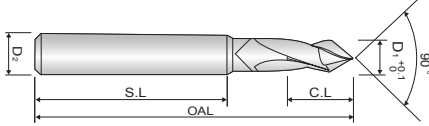

CEM ...series



EDP. No.	D ₁	C.L	S.L	OAL	D ₂	STOCK
CEM1016	10	15	80	115	16	•
CEM1216	12	20	100	145	16	•
CEM1620	16	23	100	150	20	•
CEM2025	20	25	100	155	25	•

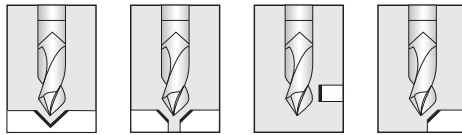

■ Tolerance

Mill Dia. (mm)	Shank Dia.
0 ~ +0,1	h7

※ Items can be changed for quality improvement without notice.

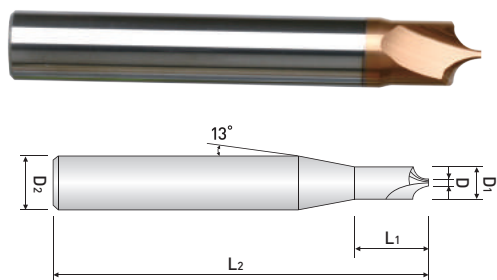

CORNER ROUNDING CUTTER

- Designed for prehardened, hardened and stainless steels and cast iron up to HRc 52.
- By using the newly developed raw-material(0.2 um), it provides excellent performance during high speed cutting.

CRC ...series



EDP. No.	D	R	D ₁	L ₁	L ₂	D ₂	STOCK
CRC 209 050	0.9	0.5	2	3	45	4	•
CRC 209 075	0.9	0.75	2.5	4	45	4	•
CRC 209 100	0.9	1.0	3	5	50	6	•
CRC 259 100	5.9	1.0	8	-	60	8	•
CRC 214 150	1.4	1.5	4.5	8	50	6	•
CRC 249 150	4.9	1.5	8	-	60	8	•
CRC 214 200	1.4	2	5.5	10	50	6	•
CRC 239 200	3.9	2	8	-	60	8	•
CRC 219 250	1.9	2.5	7	13	60	8	•
CRC 219 300	1.9	3	8	-	60	8	•
CRC 219 350	1.9	3.5	9	13	70	10	•
CRC 219 400	1.9	4	10	-	70	10	•
CRC 219 450	1.9	4.5	11	13	80	12	•
CRC 219 500	1.9	5	12	-	80	12	•
CRC 239 600	3.9	6	16	-	85	16	•
CRC 259 700	5.9	7	20	-	85	20	•
CRC 239 800	3.9	8	20	-	85	20	•



STRAIGHT FLUTE REAMERS

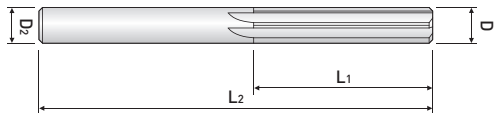

SSR ...series



EDP. No.	Dia.	C.L	OAL	SH.Dia.	Z	STOCK
SSR020	2	25	60	4	4	•
SSR025	2.5	25	60	4	4	•
SSR030	3	28	70	4	6	•
SSR035	3.5	30	75	4	6	•
SSR040	4	30	75	4	6	•
SSR045	4.5	35	80	6	6	•
SSR050	5	35	80	6	6	•
SSR055	5.5	35	80	6	6	•
SSR060	6	35	80	6	6	•
SSR065	6.5	45	100	8	6	•
SSR070	7	45	100	8	6	•
SSR080	8	45	100	8	6	•
SSR090	9	50	110	10	6	•
SSR100	10	50	110	10	6	•
SSR110	11	50	120	12	6	•
SSR120	12	50	120	12	6	•

■ Tolerance μm = 1/1000mm

Tolerance \ Dia.	from 1 to 3	over 3 to 6	over 6 to 10	over 10 to 18	over 18 to 30
Cutting Edge(m5)	+6 +2	+9 +4	+12 +6	+15 +7	+17 +8
Shank(h6)	0 -6	0 -8	0 -9	0 -11	0 -13



HELICAL FLUTE REAMERS

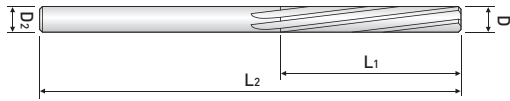

SHR ...series



EDP. No.	Dia.	C.L	OAL	SH.Dia.	Z	STOCK
SHR020	2	25	60	4	4	•
SHR025	2.5	25	60	4	4	•
SHR030	3	28	70	4	6	•
SHR035	3.5	30	75	4	6	•
SHR040	4	30	75	4	6	•
SHR045	4.5	35	80	6	6	•
SHR050	5	35	80	6	6	•
SHR055	5.5	35	80	6	6	•
SHR060	6	35	80	6	6	•
SHR065	6.5	45	100	8	6	•
SHR070	7	45	100	8	6	•
SHR080	8	45	100	8	6	•
SHR090	9	50	110	10	6	•
SHR100	10	50	110	10	6	•
SHR110	11	50	120	12	6	•
SHR120	12	50	120	12	6	•

■ Tolerance µm=1/1000mm

Tolerance \ Dia.	from 1 to 3	over 3 to 6	over 6 to 10	over 10 to 18	over 18 to 30
Cutting Edge(m5)	+6 +2	+9 +4	+12 +6	+15 +7	+17 +8
Shank(h6)	0 -6	0 -8	0 -9	0 -11	0 -13



BROACH REAMERS

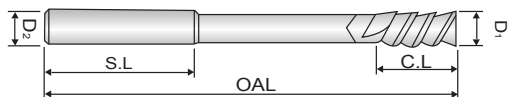

SBR ...series



EDP. No.	D ₁	C.L	S.L	OAL	D ₂	Z	STOCK
SBR030	3	12	30	70	4	4	•
SBR040	4	12	30	75	4	4	•
SBR050	5	16	35	80	6	4	•
SBR060	6	16	35	80	6	4	•
SBR080	8	20	40	100	8	4	•
SBR100	10	25	45	110	10	4	•
SBR120	12	28	50	120	12	4	•
SBR140	14	30	55	145	14	4	
SBR160	16	35	55	155	16	6	
SBR180	18	38	60	170	18	6	
SBR200	20	40	60	180	20	6	

* Above □14 will be manufactured with brazed type,

※ These tools are manufactured based on order received.

■ Tolerance μm = 1/1000mm

Tolerance	Dia.	from 1 to 3	over 3 to 6	over 6 to 10	over 10 to 18	over 18 to 30
Cutting Edge(m5)		+6	+9	+12	+15	+17
		+2	+4	+6	+7	+8
Shank(h6)		0	0	0	0	0
		-6	-8	-9	-11	-13

□ LDS series

MATERIAL	S15C-SS400 ~500N/mm ²		S45C		SCM440		SKD61 28HRC		SKD61 34HRC		FC250		AC4D	
V	63~80m/min		40~63m/min		32~50m/min		20~28m/min		16~22m/min		63~100m/min		80~160m/min	
DIAMETER (mm)	RPM (mm ⁻¹)	FEED (mm/rev)	RPM (mm ⁻¹)	FEED (mm/rev)	RPM (mm ⁻¹)	FEED (mm/rev)	RPM (mm ⁻¹)	FEED (mm/rev)	RPM (mm ⁻¹)	FEED (mm/rev)	RPM (mm ⁻¹)	FEED (mm/rev)	RPM (mm ⁻¹)	FEED (mm/rev)
3	7,500	0.04-0.08	5,500	0.04-0.08	4,500	0.04-0.08	2,500	0.04-0.08	1,500	0.04-0.08	8,000	0.05-0.09	12,000	0.10-0.22
4	5,700	0.05-0.10	4,100	0.05-0.10	3,300	0.05-0.10	1,900	0.05-0.10	1,100	0.05-0.1	6,500	0.07-0.12	9,500	0.12-0.25
6	3,800	0.06-0.12	2,700	0.06-0.12	2,300	0.06-0.12	1,250	0.06-0.12	750	0.06-0.12	4,300	0.12-0.18	6,400	0.14-0.28
8	2,800	0.08-0.15	2,000	0.08-0.15	1,700	0.08-0.15	950	0.08-0.15	550	0.08-0.15	3,200	0.13-0.20	4,800	0.18-0.32
10	2,300	0.10-0.18	1,700	0.10-0.18	1,400	0.10-0.18	750	0.10-0.18	450	0.1-0.18	2,600	0.17-0.25	3,800	0.22-0.36
12	1,900	0.12-0.21	1,400	0.12-0.21	1,200	0.12-0.21	650	0.12-0.21	370	0.12-0.21	2,200	0.21-0.30	3,200	0.25-0.40
16	1,400	0.16-0.28	1,000	0.16-0.28	900	0.16-0.28	500	0.16-0.28	280	0.16-0.28	1,600	0.24-0.32	2,400	0.32-0.48
20	1,150	0.20-0.34	820	0.20-0.34	700	0.20-0.34	400	0.20-0.34	220	0.2-0.34	1,300	0.26-0.40	1,900	0.40-0.60
25	900	0.25-0.45	650	0.25-0.45	560	0.25-0.45	300	0.25-0.45	180	0.25-0.45	1,000	0.30-0.50	1,500	0.50-0.75

□ Recommendation of Cutting Conditions in Reamer

WORKPIECE			DIAMETER	CUTTING CONDITIONS	
Material	Tensile strength(Kg/mm ²)	Hardness(HB)		V (m/min)	f (mm/rev)
Carbon Steel Alloy Steel	~ 100		~10 10~25 25~40	8 ~ 12	0.15 ~ 0.25 0.20 ~ 0.40 0.30 ~ 0.50
	100 ~ 140		~10 10~25 25~40	6 ~ 10	0.12 ~ 0.20 0.15 ~ 0.30 0.20 ~ 0.40
Steel Castings	40 ~ 50		~10 10~25 25~40	8 ~ 12	0.15 ~ 0.25 0.20 ~ 0.40 0.30 ~ 0.50
	50 ~ 70		~10 10~25 25~40	6 ~ 10	0.12 ~ 0.20 0.15 ~ 0.30 0.20 ~ 0.40
Cast Irons		~ 200	~10 10~25 25~40	8 ~ 15	0.20 ~ 0.30 0.30 ~ 0.50 0.40 ~ 0.70
		200 ~	~10 10~25 25~40	6 ~ 12	0.15 ~ 0.25 0.20 ~ 0.40 0.30 ~ 0.50
Aluminum Alloys			~10	15 ~ 25	0.20 ~ 0.30 0.30 ~ 0.50 0.40 ~ 0.70
			10~25 25~40	20 ~30	

□ The Effect of Chamfer

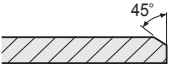
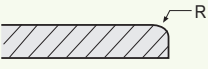
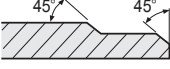
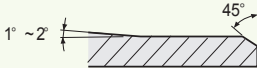
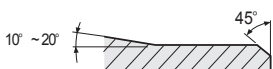
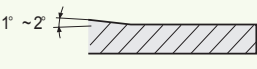
TWIST DIRECTION	CHARACTERISTICS
	If the work piece is caught by sharp blade edge, dent occurs on the machined surface. It is applied to chucking reamer, etc.
	Guide edge was rounded. The ground surface is excellent but round machining is difficult and it may deteriorate the machined surface.
	It is 2 blade-type. Chip is produced in 2 stages and it provides good results. But regrinding is difficult.
	The guide part of second stage of cutting edge is 1~2°. Cutting edge blade is long and life is limited. It provides good results on finish machining
	The guide part of second stage is 10~20. It is very economical as the length of blade is short and utilized length is long
	It is used for finish machining. It is applied to hand reamer.

□ The Effect of Twist Angle

TWIST DIRECTION	CHARACTERISTICS
Straight blade (twist angle is 0°)	<ul style="list-style-type: none"> • Surface is generally poor except cast iron.
Right twist blade	<ul style="list-style-type: none"> • Excellent machinability and easy to discharge chip • Applicable work piece range is wide • Excellent for high hardness work piece
Left twist blade	<ul style="list-style-type: none"> • Excellent surface roughness for work piece of aluminium alloys, copper, and copper alloys • It is good for machining soft materials

▣ Trouble Shooting of Reaming

TROUBLE	PLAN	MEASURES
Enlarged Hole	Increase burnishing effects	<ul style="list-style-type: none"> • Decrease chamfer angle • Decrease back taper • Use S.Cl type cutting oil • Increase margin width • Grind 2 stages chamfer • Check reamer diameter
	Suppress the occurrence of built-up-edge	<ul style="list-style-type: none"> • Increase margin width • Change heat treatment conditions and microstructure of workpiece • Increase cutting oil supply • Increase cutting speed and reduce feed rate • Grind 2 stages chamfer
	Reduce the unbalance of cutting force	<ul style="list-style-type: none"> • The cutting edge difference shall be less than 0.005mm • Increase cutting speed • Reduce the deviation of main axis and basic Diameter • Check wear conditions of bush and replace it • Change water soluble cutting oil to non-water soluble oil
Shrunked Hole	Reduce finish effects	<ul style="list-style-type: none"> • Increase the clearance angle of cutting edge • Decrease margin width • Increase cutting speed • Increase back taper
Poor roundness	Reduce Chattering	<ul style="list-style-type: none"> • Increase the strength of machine • Change to left helix reamer • Increase back taper • Increase feed rate • Reduce the tolerance of bush • Increase margin width • Decrease cutting speed
Poor surface roughness	Increase burnishing	<ul style="list-style-type: none"> • Use left helix • Grind with 2 stage chamfer • Decrease chamfer angle
	Remove deposit	<ul style="list-style-type: none"> • Increase rake angle • Reduce feed rate • Increase cutting speed
	Remove chattering	<ul style="list-style-type: none"> • The cutting edge difference shall be less than 0.005mm • Increase cutting speed • Align main axis center and basic diameter center • Change water soluble cutting oil to non-water soluble oil
	Remove chip interference	<ul style="list-style-type: none"> • Change shape of flute type • Increase the depth of flute

TAP series



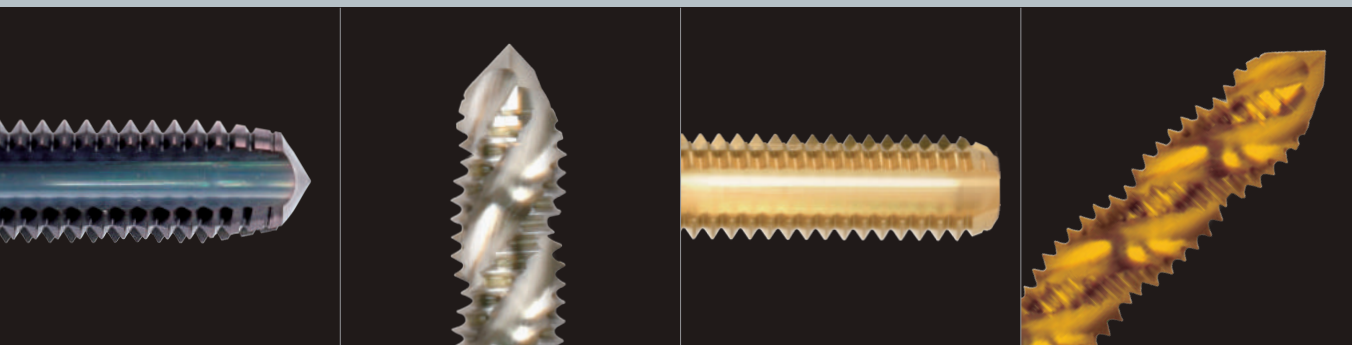

}	Carbide Tap Series	385
	Hss Tap Series	393
	Technical Data - Cutting Conditions	408

Tap Series

WIDIN

	EDP. No.	APPEARANCE	FEATURE	STOCK	PAGE
Carbide Tap Series	Straight Taps (Uncoated)		WSOM...series	•	385
	Straight Taps (Coated TiCN)		WSCM...series	•	386
	Spiral Taps (Uncoated)		WPOM...series	•	387
	Spiral Taps (Coated TiCN)		WPCM...series	•	388
	Roll Taps (Uncoated)		WROM...series	•	389
	Roll Taps (Coated TiCN)		WRCM...series	•	390
	Spiral Roll Taps (Uncoated)		WFOM...series	•	391
	Spiral Roll Taps (Coated TiCN)		WFCM...series	•	392
Hss Tap Series	Straight Taps (Uncoated)		VSOM...series	•	393
	Straight Taps (Coated TiN)		VSTM...series	•	394
	Straight Taps (Coated TiCN)		VSCM...series	•	395
	Point Taps (Uncoated)		VNOM...series	•	396
	Point Taps (Coated TiN)		VNTM...series	•	397
	Point Taps (Coated TiCN)		VNCM...series	•	398
	Spiral Taps (Uncoated)		VPOM...series	•	399
	Spiral Taps (Coated TiN)		VPTM...series	•	400
	Spiral Taps (Coated TiCN)		VPCM...series	•	401
	Roll Taps (Uncoated)		VROM...series	•	402
	Roll Taps (Coated TiN)		VRTM...series	•	403
	Roll Taps (Coated TiCN)		VRCM...series	•	404
	Spiral Roll Taps (Uncoated)		VFOM...series	•	405
	Spiral Roll Taps (Coated TiN)		VFTM...series	•	406
	Spiral Roll Taps (Coated TiCN)		VFCM...series	•	407

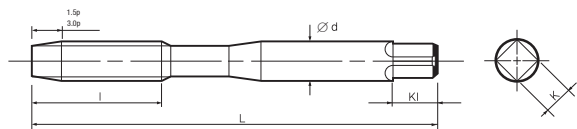

STRAIGHT TAPS

- Designed for high mass production for general workpieces such as Cast Iron, C.Br, Plastics and so on.

WSOM...series



EDP. No.		Thread Size	Limits	L	l	d	K	KI	Flutes	STOCK
1.5P	3P									
WSOM0305015	WSOM0305030	M3 X 0.5	WH3	46	11	4	3.2	6	3	•
WSOM0407015	WSOM0407030	M4 X 0.7		52	13	5	4	7		•
WSOM0508015	WSOM0508030	M5 X 0.8		60	16	5.5	4.5	7		•
WSOM0610015	WSOM0610030	M6 X 1.0		62	19	6	4.5	7		•
WSOM0810015	WSOM0810030	M8 X 1.0	WH3	70	22	6.2	5	8	4	•
WSOM0812515	WSOM0812530	M8 X 1.25	WH4							•
WSOM1010015	WSOM1010030	M10 X 1.0	WH3	75	24	7	5.5	8		•
WSOM1012515	WSOM1012530	M10 X 1.25	WH4							•
WSOM1015015	WSOM1015030	M10 X 1.5								•
WSOM1210015	WSOM1210030	M12 X 1.0	WH3	82	29	8.5	6.5	9		•
WSOM1212515	WSOM1212530	M12 X 1.25	WH4							•
WSOM1215015	WSOM1215030	M12 X 1.5								•
WSOM1217515	WSOM1217530	M12 X 1.75	WH5							•
										•

Work Material

Low Carbon Steels	Medium Carbon Steels	High Carbon Steels	Alloy Steels	Hardened Steels			Stainless Steels	Tool Steels	Cast Steels	Cast Iron	Ductile Cast Iron	Copper	Brass	Brass Casting	Bronze	Aluminum Rolled	Aluminum Alloy Casting	Magnesium Alloy Casting	Zinc Alloy Casting	Titanium Alloys	Nickel Alloys	Thermo Setting Plastic	Thermo Plastic	
C	C	C	SCM	25-45 HRC	45-55 HRC	50-60 HRC	SUS	SKD	SC	FC	FCD	Cu	Bs	BsC	PB	AL	AC,ADC	MC	ZDC					
-0.25%	0.25% -0.45%	0.45% -								☉	○		○	○	☉		○	○	○				☉	

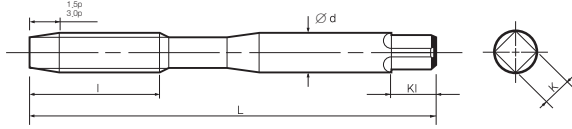

STRAIGHT TAPS

- Designed for high mass production for general workpieces such as Cast Iron, C.Br, Plastics, and so on.
- By applying TiCN coating, it provides stable and highly efficient operation due to enhanced durability.

WSCM...series



EDP. No.		Thread Size	Limits	L	l	d	K	KI	Flutes	STOCK
1.5P	3P									
WSCM0305015	WSCM0305030	M3 X 0.5	WH3	46	11	4	3.2	6	3	•
WSCM0407015	WSCM0407030	M4 X 0.7		52	13	5	4	7		•
WSCM0508015	WSCM0508030	M5 X 0.8		60	16	5.5	4.5	7		•
WSCM0610015	WSCM0610030	M6 X 1.0		62	19	6	4.5	7		•
WSCM0810015	WSCM0810030	M8 X 1.0	WH3	70	22	6.2	5	8	4	•
WSCM0812515	WSCM0812530	M8 X 1.25	WH4							•
WSCM1010015	WSCM1010030	M10 X 1.0	WH3	75	24	7	5.5	8		•
WSCM1012515	WSCM1012530	M10 X 1.25	WH4							•
WSCM1015015	WSCM1015030	M10 X 1.5								•
WSCM1210015	WSCM1210030	M12 X 1.0	WH3	82	29	8.5	6.5	9		•
WSCM1212515	WSCM1212530	M12 X 1.25	WH4							•
WSCM1215015	WSCM1215030	M12 X 1.5								•
WSCM1217515	WSCM1217530	M12 X 1.75	WH5						•	

Work Material

Low Carbon Steels	Medium Carbon Steels	High Carbon Steels	Alloy Steels	Hardened Steels			Stainless Steels	Tool Steels	Cast Steels	Cast Iron	Ductile Cast Iron	Copper	Brass	Brass Casting	Bronze	Aluminum Rolled	Aluminum Alloy Casting	Magnesium Alloy Casting	Zinc Alloy Casting	Titanium Alloys	Nickel Alloys	Thermo Setting Plastic	Thermo Plastic	
C -0.25%	C0.25% -0.45%	C 0.45%-	SCM	25-45 HRC	45-55 HRC	50-60 HRC	SUS	SKD	SC	FC	FCD	Cu	Bs	BsC	PB	AL	AC,ADC	MC	ZDC					
										☉	○		○	○	☉		○	○	○				☉	

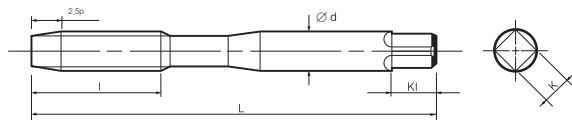

SPIRAL TAPS

- Designed for high mass production for general workpieces such as Cast Iron, C.Br, Plastics and so on.
- Suitable for tapping of through and blind holes.

WPOM...series



EDP. No. 2.5P	Thread Size	Limits	L	l	d	K	KI	STOCK
WPOM0305025	M3 X 0.5	WH3	46	11	4	3.2	6	•
WPOM0407025	M4 X 0.7		52	13	5	4	7	•
WPOM0508025	M5 X 0.8		60	16	5.5	4.5	7	•
WPOM0610025	M6 X 1.0		62	19	6	4.5	7	•
WPOM0810025	M8 X 1.0	WH3	70	22	6.2	5	8	•
WPOM0812525	M8 X 1.25	WH4						•
WPOM1010025	M10 X 1.0	WH3	75	24	7	5.5	8	•
WPOM1012525	M10 X 1.25	WH4						•
WPOM1015025	M10 X 1.5							•
WPOM1210025	M12 X 1.0	WH4						82
WPOM1212525	M12 X 1.25		•					
WPOM1215025	M12 X 1.5		•					
WPOM1217525	M12 X 1.75		•					

Work Material

Low Carbon Steels	Medium Carbon Steels	High Carbon Steels	Alloy Steels	Hardened Steels			Stainless Steels	Tool Steels	Cast Steels	Cast Iron	Ductile Cast Iron	Copper	Brass	Brass Casting	Bronze	Aluminum Rolled	Aluminum Alloy Casting	Magnesium Alloy Casting	Zinc Alloy Casting	Titanium Alloys	Nickel Alloys	Thermo Setting Plastic	Thermo Plastic	
C -0.25%	C0.25% -0.45%	C 0.45%-	SCM	25-45 HRC	45-55 HRC	50-60 HRC	SUS	SKD	SC	FC	FCD	Cu	Bs	BsC	PB	AL	AC,ADC	MC	ZDC					
										○	◎	◎	◎	◎	○	○	○	○	○					◎

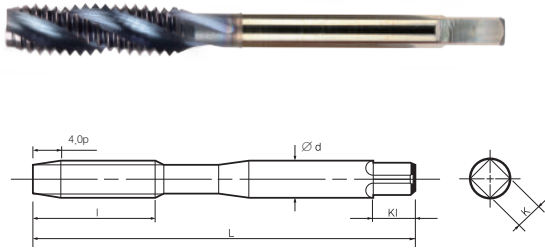

SPIRAL TAPS

- Designed for high mass production for general work pieces such as Cast Iron, C.Br, Plastics and so on.
- Suitable for tapping of through and blind holes.
- By applying TiCN coating, it provides stable and highly efficient operation due to enhanced durability.

WPCM...series



EDP. No. 2.5P	Thread Size	Limits	L	l	d	K	KI	STOCK
WPCM0305025	M3 X 0.5	WH3	46	11	4	3.2	6	•
WPCM0407025	M4 X 0.7		52	13	5	4	7	•
WPCM0508025	M5 X 0.8		60	16	5.5	4.5	7	•
WPCM0610025	M6 X 1.0		62	19	6	4.5	7	•
WPCM0810025	M8 X 1.0	WH3	70	22	6.2	5	8	•
WPCM0812525	M8 X 1.25	WH4						•
WPCM1010025	M10 X 1.0	WH3	75	24	7	5.5	8	•
WPCM1012525	M10 X 1.25	WH4						•
WPCM1015025	M10 X 1.5							•
WPCM1210025	M12 X 1.0	WH4	82	29	8.5	6.5	9	•
WPCM1212525	M12 X 1.25							•
WPCM1215025	M12 X 1.5							•
WPCM1217525	M12 X 1.75							•

Work Material

Low Carbon Steels	Medium Carbon Steels	High Carbon Steels	Alloy Steels	Hardened Steels			Stainless Steels	Tool Steels	Cast Steels	Cast Iron	Ductile Cast Iron	Copper	Brass	Brass Casting	Bronze	Aluminum Rolled	Aluminum Alloy Casting	Magnesium Alloy Casting	Zinc Alloy Casting	Titanium Alloys	Nickel Alloys	Thermo Setting Plastic	Thermo Plastic	
C -0.25%	C0.25% -0.45%	C 0.45%-	SCM	25-45 HRC	45-55 HRC	50-60 HRC	SUS	SKD	SC	FC	FCD	Cu	Bs	BsC	PB	AL	AC,ADC	MC	ZDC					
										○	◎	◎	◎	◎	○	○	◎	◎	◎				○	◎

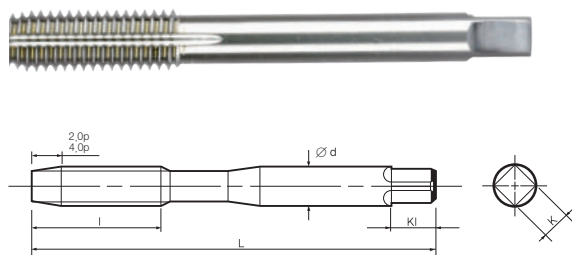

ROLL TAPS

- Designed for high performance of threading Nonferrous metals.
- Suitable for tapping of through and blind holes.

WROM...series



EDP. No.		Thread Size	Limits	L	l	d	K	Kl	Oil Groove	STOCK
2P	4P									
WROM0305020S	WROM0305040S	M3 X 0.5	GH5	46	11	4	3.2	6	1	•
WROM0305020M	WROM0305040M								4	•
WROM0407020S	WROM0407040S	M4 X 0.7	GH6	52	13	5	4	7	1	•
WROM0407020M	WROM0407040M								4	•
WROM0508020S	WROM0508040S	M5 X 0.8	GH6	60	16	5.5	4.5	7	1	•
WROM0508020M	WROM0508040M								4	•
WROM0610020S	WROM0610040S	M6 X 1.0	GH7	62	19	6	4.5	7	1	•
WROM0610020M	WROM0610040M								4	•
WROM0812520S	WROM0812540S	M8 X 1.25	GH7	70	22	6.2	5	8	1	•
WROM0812520M	WROM0812540M								4	•
WROM1012520S	WROM1012540S	M10 X 1.25	GH7	75	24	7	5.5	8	1	•
WROM1012520M	WROM1012540M								4	•
WROM1015020S	WROM1015040S	M10 X 1.50	GH7	75	24	7	5.5	8	1	•
WROM1015020M	WROM1015040M								4	•
WROM1210020S	WROM1210040S	M12 X 1.0	GH7	82	29	8.5	6.5	9	1	•
WROM1210020M	WROM1210040M								4	•
WROM1212520S	WROM1212540S	M12 X 1.25	GH7	82	29	8.5	6.5	9	1	•
WROM1212520M	WROM1212540M								4	•
WROM1215020S	WROM1215040S	M12 X 1.5	GH7	82	29	8.5	6.5	9	1	•
WROM1215020M	WROM1215040M								4	•
WROM1217520S	WROM1217540S	M12 X 1.75	GH8	82	29	8.5	6.5	9	1	•
WROM1217520M	WROM1217540M								4	•

■ Work Material

Low Carbon Steels	Medium Carbon Steels	High Carbon Steels	Alloy Steels	Hardened Steels			Stainless Steels	Tool Steels	Cast Steels	Cast Iron	Ductile Cast Iron	Copper	Brass	Brass Casting	Bronze	Aluminum Rolled	Aluminum Alloy Casting	Magnesium Alloy Casting	Zinc Alloy Casting	Titanium Alloys	Nickel Alloys	Thermo Setting Plastic	Thermo Plastic
C -0.25%	C0.25% -0.45%	C 0.45%-	SCM	25-45 HRC	45-55 HRC	50-60 HRC	SUS	SKD	SC	FC	FCD	Cu	Bs	BsC	PB	AL	AC,ADC	MC	ZDC				
												◎	◎	◎		◎	◎		◎				

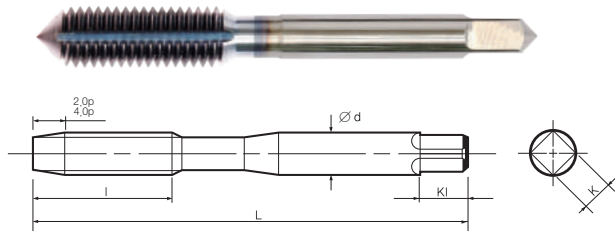

ROLL TAPS

- It is applicable regardless of steel or Nonferrous alloys.
- By applying TiCN coating, it provides stable and highly efficient operation due to enhanced durability.

WRCM...series



EDP. No.		Thread Size	Limits	L	l	d	K	KI	Oil Groove	STOCK
2P	4P									
WRCM0305020S	WRCM0305040S	M3 X 0.5	GH5	46	11	4	3.2	6	1	•
WRCM0305020M	WRCM0305040M								4	•
WRCM0407020S	WRCM0407040S	M4 X 0.7	GH6	52	13	5	4	7	1	•
WRCM0407020M	WRCM0407040M								4	•
WRCM0508020S	WRCM0508040S	M5 X 0.8	GH6	60	16	5.5	4.5	7	1	•
WRCM0508020M	WRCM0508040M								4	•
WRCM0610020S	WRCM0610040S	M6 X 1.0	GH7	62	19	6	4.5	7	1	•
WRCM0610020M	WRCM0610040M								4	•
WRCM0812520S	WRCM0812540S	M8 X 1.25	GH7	70	22	6.2	5	8	1	•
WRCM0812520M	WRCM0812540M								4	•
WRCM1012520S	WRCM1012540S	M10 X 1.25	GH7	75	24	7	5.5	8	1	•
WRCM1012520M	WRCM1025040M								4	•
WRCM1015020S	WRCM1015040S	M10 X 1.50	GH7	75	24	7	5.5	8	1	•
WRCM1015020M	WRCM1015040M								4	•
WRCM1210020S	WRCM1210040S	M12 X 1.0	GH7	82	29	8.5	6.5	9	1	•
WRCM1210020M	WRCM1210040M								4	•
WRCM1212520S	WRCM1212540S	M12 X 1.25	GH7	82	29	8.5	6.5	9	1	•
WRCM1212520M	WRCM1212540M								4	•
WRCM1215020S	WRCM1215040S	M12 X 1.5	GH7	82	29	8.5	6.5	9	1	•
WRCM1215020M	WRCM1215040M								4	•
WRCM1217520S	WRCM1217540S	M12 X 1.75	GH8	82	29	8.5	6.5	9	1	•
WRCM1217520M	WRCM1217540M								4	•

Work Material

Low Carbon Steels	Medium Carbon Steels	High Carbon Steels	Alloy Steels	Hardened Steels			Stainless Steels	Tool Steels	Cast Steels	Cast Iron	Ductile Cast Iron	Copper	Brass	Brass Casting	Bronze	Aluminum Rolled	Aluminum Alloy Casting	Magnesium Alloy Casting	Zinc Alloy Casting	Titanium Alloys	Nickel Alloys	Thermo Setting Plastic	Thermo Plastic
C -0.25%	C0.25% -0.45%	C 0.45%-	SCM	25-45 HRC	45-55 HRC	50-60 HRC	SUS	SKD	SC	FC	FCD	Cu	Bs	BsC	PB	AL	AC,ADC	MC	ZDC				
○	○	○	○				○					○	○	○		○	○		○				

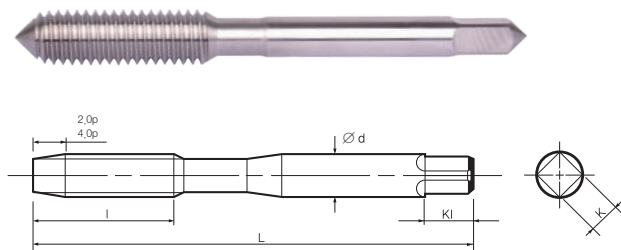

SPIRAL ROLL TAPS

- Designed for high performance of threading
Nonferrous alloys, Aluminum, Magnesium,
Zinc and Copper.

WFOM...series



EDP. No.		Thread Size	Limits	L	l	d	K	KI	STOCK
2P	4P								
WFOM0305020	WFOM0305040	M3 X 0.5	GH6	46	18	4	3.2	6	•
WFOM03506020	WFOM03506040	M3.5 X 0.6	GH6	46	18	4	3.2	6	•
WFOM0407020	WFOM0305040	M4 X 0.7	GH7	52	20	5	4	7	•
WFOM0508020	WFOM0508040	M5 X 0.8	GH7	60	22	5.5	4.5	7	•
WFOM0610020	WFOM0610040	M6 X 1.0	GH7	62	24	6	4.5	7	•

■ Work Material

Low Carbon Steels	Medium Carbon Steels	High Carbon Steels	Alloy Steels	Hardened Steels			Stainless Steels	Tool Steels	Cast Steels	Cast Iron	Ductile Cast Iron	Copper	Brass	Brass Casting	Bronze	Aluminum Rolled	Aluminum Alloy Casting	Magnesium Alloy Casting	Zinc Alloy Casting	Titanium Alloys	Nickel Alloys	Thermo Setting Plastic	Thermo Plastic
C -0,25%	C0,25% -0,45%	C 0,45%-	SCM	25-45 HRC	45-55 HRC	50-60 HRC	SUS	SKD	SC	FC	FCD	Cu	Bs	BsC	PB	AL	AC,ADC	MC	ZDC				
												◎	◎	◎		◎	◎		◎				

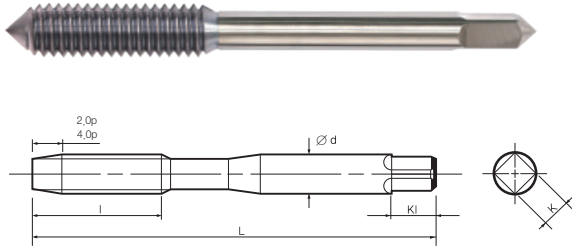

SPIRAL ROLL TAPS

- Designed for high performance of threading Steel, Nonferrous alloys and Stainless steel.
- By applying TiCN coating, it provides stable and highly efficient operation due to enhanced durability.

WFCM...series



EDP. No.		Thread Size	Limits	L	l	d	K	KI	STOCK
2P	4P								
WFCM0305020	WFCM0305040	M3 X 0.5	GH6	46	18	4	3.2	6	•
WFCM03506020	WFCM03506040	M3.5 X 0.6	GH6	46	18	4	3.2	6	•
WFCM0407020	WFCM0407040	M4 X 0.7	GH7	52	20	5	4	7	•
WFCM0508020	WFCM0508040	M5 X 0.8	GH7	60	22	5.5	4.5	7	•
WFCM0610020	WFCM0610040	M6 X 1.0	GH7	62	24	6	4.5	7	•

Work Material

Low Carbon Steels	Medium Carbon Steels	High Carbon Steels	Alloy Steels	Hardened Steels			Stainless Steels	Tool Steels	Cast Steels	Cast Iron	Ductile Cast Iron	Copper	Brass	Brass Casting	Bronze	Aluminum Rolled	Aluminum Alloy Casting	Magnesium Alloy Casting	Zinc Alloy Casting	Titanium Alloys	Nickel Alloys	Thermo Setting Plastic	Thermo Plastic
C -0.25%	C0,25% -0,45%	C 0,45%-	SCM	25-45 HRC	45-55 HRC	50-60 HRC	SUS	SKD	SC	FC	FCD	Cu	Bs	BsC	PB	AL	AC,ADC	MC	ZDC				
○	○	○	○				○					○	○	○		○	○		○				

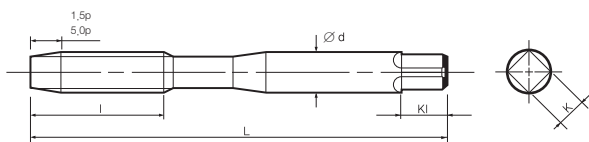

STRAIGHT TAPS

- Designed for high performance of threading Cast Iron, Medium Carbon steel, Nonferrous metals and so on.

VSOM...series



EDP. No.		Thread Size	Limits	L	l	d	K	KI	Flutes	STOCK
1.5P	5P									
VSOM0305015	VSOM0305050	M3 X 0.5	WH2	46	11	4	3.2	6	3	•
VSOM0407015	VSOM0407050	M4 X 0.7	WH2	52	13	5	4	7	3	•
VSOM0508015	VSOM0508050	M5 X 0.8	WH2	60	16	5.5	4.5	7	3	•
VSOM0610015	VSOM0610050	M6 X 1.0	WH2	62	19	6	4.5	7	3	•
VSOM0812515	VSOM0812550	M8 X 1.25	WH2	70	22	6.2	5	8	4	•
VSOM1012515	VSOM1012550	M10 X 1.25	WH2	75	24	7	5.5	8	4	•
VSOM1015015	VSOM1015050	M10 X 1.5	WH3	75	24	7	5.5	8	4	•
VSOM1210015	VSOM1210050	M12 X 1.0	WH2	82	29	8.5	6.5	9	4	•
VSOM1212515	VSOM1212550	M12 X 1.25	WH2	82	29	8.5	6.5	9	4	•
VSOM1215015	VSOM1215050	M12 X 1.5	WH3	82	29	8.5	6.5	9	4	•
VSOM1217515	VSOM1217550	M12 X 1.75	WH3	82	29	8.5	6.5	9	4	•
VSOM1415015	VSOM1415050	M14 X 1.5	WH3	88	30	10.5	8	11	4	•
VSOM1420015	VSOM1420050	M14 X 2.0	WH3	88	30	10.5	8	11	4	•
VSOM1615015	VSOM1615050	M16 X 1.5	WH3	95	32	12.5	10	13	4	•
VSOM1620015	VSOM1620050	M16 X 2.0	WH3	95	32	12.5	10	13	4	•
VSOM1815015	VSOM1815050	M18 X 1.5	WH3	100	37	14	11	14	4	•
VSOM1825015	VSOM1825050	M18 X 2.5	WH3	100	37	14	11	14	4	•
VSOM2015015	VSOM2015050	M20 X 1.5	WH3	105	37	15	12	15	4	•
VSOM2025015	VSOM2025050	M20 X 2.5	WH3	105	37	15	12	15	4	•

■ Work Material

Low Carbon Steels	Medium Carbon Steels	High Carbon Steels	Alloy Steels	Hardened Steels			Stainless Steels	Tool Steels	Cast Steels	Cast Iron	Ductile Cast Iron	Copper	Brass	Brass Casting	Bronze	Aluminum Rolled	Aluminum Alloy Casting	Magnesium Alloy Casting	Zinc Alloy Casting	Titanium Alloys	Nickel Alloys	Thermo Setting Plastic	Thermo Plastic
C -0.25%	C0.25% -0.45%	C 0.45%-	SCM	25-45 HRC	45-55 HRC	50-60 HRC	SUS	SKD	SC	FC	FCD	Cu	Bs	BsC	PB	AL	AC,ADC	MC	ZDC				
○	○										○		○	○	○	○	○	○	○				

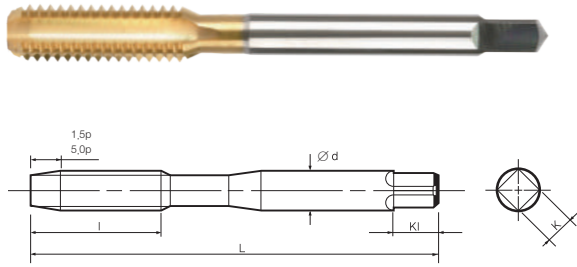

STRAIGHT TAPS

- Designed for high performance of threading Carbon steel, Alloy steel and Nonferrous metals.
- Suitable for tapping of through and blind holes.
- By applying TiN coating, it provides stable and highly efficient operation due to enhanced durability.

VSTM...series



EDP. No.		Thread Size	Limits	L	l	d	K	KI	Flutes	STOCK
1.5P	5P									
VSTM0305015	VSTM0305050	M3 X 0.5	WH2	46	11	4	3.2	6	3	•
VSTM0407015	VSTM0407050	M4 X 0.7	WH2	52	13	5	4	7	3	•
VSTM0508015	VSTM0508050	M5 X 0.8	WH2	60	16	5.5	4.5	7	3	•
VSTM0610015	VSTM0610050	M6 X 1.0	WH2	62	19	6	4.5	7	3	•
VSTM0812515	VSTM0812550	M8 X 1.25	WH2	70	22	6.2	5	8	4	•
VSTM1012515	VSTM1012550	M10 X 1.25	WH2	75	24	7	5.5	8	4	•
VSTM1015015	VSTM1015050	M10 X 1.5	WH3	75	24	7	5.5	8	4	•
VSTM1210015	VSTM1210050	M12 X 1.0	WH2	82	29	8.5	6.5	9	4	•
VSTM1212515	VSTM1212530	M12 X 1.25	WH2	82	29	8.5	6.5	9	4	•
VSTM1215015	VSTM1215050	M12 X 1.5	WH3	82	29	8.5	6.5	9	4	•
VSTM1217515	VSTM1217550	M12 X 1.75	WH3	82	29	8.5	6.5	9	4	•
VSTM1415015	VSTM1415050	M14 X 1.5	WH3	88	30	10.5	8	11	4	•
VSTM1420015	VSTM1420050	M14 X 2.0	WH3	88	30	10.5	8	11	4	•
VSTM1615015	VSTM1615050	M16 X 1.5	WH3	95	32	12.5	10	13	4	•
VSTM1620015	VSTM1620050	M16 X 2.0	WH3	95	32	12.5	10	13	4	•
VSTM1815015	VSTM1815050	M18 X 1.5	WH3	100	37	14	11	14	4	•
VSTM1825015	VSTM1825050	M18 X 2.5	WH3	100	37	14	11	14	4	•
VSTM2015015	VSTM2015050	M20 X 1.5	WH3	105	37	15	12	15	4	•
VSTM2025015	VSTM2025050	M20 X 2.5	WH3	105	37	15	12	15	4	•

Work Material

Low Carbon Steels	Medium Carbon Steels	High Carbon Steels	Alloy Steels	Hardened Steels			Stainless Steels	Tool Steels	Cast Steels	Cast Iron	Ductile Cast Iron	Copper	Brass	Brass Casting	Bronze	Aluminum Rolled	Aluminum Alloy Casting	Magnesium Alloy Casting	Zinc Alloy Casting	Titanium Alloys	Nickel Alloys	Thermo Setting Plastic	Thermo Plastic
C -0.25%	C0.25% -0.45%	C 0.45%--	SCM	25-45 HRC	45-55 HRC	50-60 HRC	SUS	SKD	SC	FC	FCD	Cu	Bs	BsC	PB	AL	AC,ADC	MC	ZDC				
○	○	○	○	○									○	○	○	○	○	○	○				

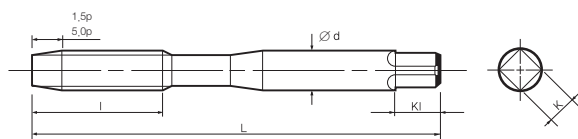

STRAIGHT TAPS

- Designed for high performance of threading Carbon steel, Alloy steel and Nonferrous metals.
- Suitable for tapping of through and blind holes.
- By applying TiCN coating, it provides stable and highly efficient operation due to enhanced durability.

VSCM...series



EDP. No.		Thread Size	Limits	L	l	d	K	KI	Flutes	STOCK
1.5P	5P									
VSCM0305015	VSCM0305030	M3 X 0.5	WH2	46	11	4	3.2	6	3	•
VSCM0407015	VSCM0407030	M4 X 0.7	WH2	52	13	5	4	7	3	•
VSCM0508015	VSCM0508030	M5 X 0.8	WH2	60	16	5.5	4.5	7	3	•
VSCM0610015	VSCM0610030	M6 X 1.0	WH2	62	19	6	4.5	7	3	•
VSCM0812515	VSCM0812530	M8 X 1.25	WH2	70	22	6.2	5	8	4	•
VSCM1012515	VSCM1012530	M10 X 1.25	WH2	75	24	7	5.5	8	4	•
VSCM1015015	VSCM1015030	M10 X 1.5	WH3	75	24	7	5.5	8	4	•
VSCM1210015	VSCM1210030	M12 X 1.0	WH2	82	29	8.5	6.5	9	4	•
VSCM1212515	VSCM1212530	M12 X 1.25	WH2	82	29	8.5	6.5	9	4	•
VSCM1215015	VSCM1215030	M12 X 1.5	WH3	82	29	8.5	6.5	9	4	•
VSCM1217515	VSCM1217530	M12 X 1.75	WH3	82	29	8.5	6.5	9	4	•
VSCM1415015	VSCM1415030	M14 X 1.5	WH3	88	30	10.5	8	11	4	•
VSCM1420015	VSCM1420030	M14 X 2.0	WH3	88	30	10.5	8	11	4	•
VSCM1615015	VSCM1615030	M16 X 1.5	WH3	95	32	12.5	10	13	4	•
VSCM1620015	VSCM1620030	M16 X 2.0	WH3	95	32	12.5	10	13	4	•
VSCM1815015	VSCM1815030	M18 X 1.5	WH3	100	37	14	11	14	4	•
VSCM1825015	VSCM1825030	M18 X 2.5	WH3	100	37	14	11	14	4	•
VSCM2015015	VSCM2015030	M20 X 1.5	WH3	105	37	15	12	15	4	•
VSCM2025015	VSCM2025030	M20 X 2.5	WH3	105	37	15	12	15	4	•

■ Work Material

Low Carbon Steels	Medium Carbon Steels	High Carbon Steels	Alloy Steels	Hardened Steels			Stainless Steels	Tool Steels	Cast Steels	Cast Iron	Ductile Cast Iron	Copper	Brass	Brass Casting	Bronze	Aluminum Rolled	Aluminum Alloy Casting	Magnesium Alloy Casting	Zinc Alloy Casting	Titanium Alloys	Nickel Alloys	Thermo Setting Plastic	Thermo Plastic
C -0.25%	C0.25% -0.45%	C 0.45%-	SCM	25-45 HRC	45-55 HRC	50-60 HRC	SUS	SKD	SC	FC	FCD	Cu	Bs	BsC	PB	AL	AC,ADC	MC	ZDC				
○	○	○	○	○									○	○	○	○	○	○	○				

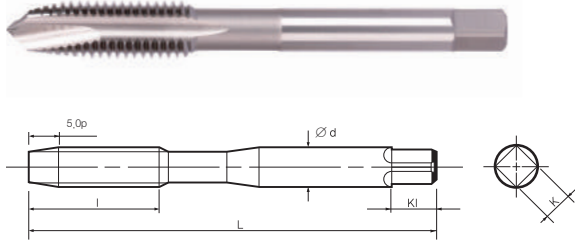

POINT TAPS

- Designed for high performance of threading Carbon steel, Alloy steel and Nonferrous metals.
- Suitable for tapping of through holes.

VNOM...series



EDP. No. 5P	Thread Size	Limits	L	l	d	K	KI	STOCK
VNOM0305050	M3 X 0.5	WH2	46	11	4	3.2	6	•
VNOM0407050	M4 X 0.7	WH2	52	13	5	4	7	•
VNOM0508050	M5 X 0.8	WH2	60	16	5.5	4.5	7	•
VNOM0610050	M6 X 1.0	WH2	62	19	6	4.5	7	•
VNOM0812550	M8 X 1.25	WH3	70	22	6.2	5	8	•
VNOM1012550	M10 X 1.25	WH3	75	24	7	5.5	8	•
VNOM1015050	M10 X 1.5	WH3	75	24	7	5.5	8	•
VNOM1210050	M12 X 1.0	WH3	82	29	8.5	6.5	9	•
VNOM1212550	M12 X 1.25	WH3	82	29	8.5	6.5	9	•
VNOM1215050	M12 X 1.5	WH3	82	29	8.5	6.5	9	•
VNOM1217550	M12 X 1.75	WH4	82	29	8.5	6.5	9	•
VNOM1415050	M14 X 1.5	WH3	88	30	10.5	8	11	•
VNOM1420050	M14 X 2.0	WH4	88	30	10.5	8	11	•
VNOM1615050	M16 X 1.5	WH3	95	32	12.5	10	13	•
VNOM1620050	M16 X 2.0	WH4	95	32	12.5	10	13	•
VNOM1815050	M18 X 1.5	WH4	100	37	14	11	14	•
VNOM1825050	M18 X 2.5	WH4	100	37	14	11	14	•
VNOM2015050	M20 X 1.5	WH4	105	37	15	12	15	•
VNOM2025050	M20 X 2.5	WH4	105	37	15	12	15	•

■ Work Material

Low Carbon Steels	Medium Carbon Steels	High Carbon Steels	Alloy Steels	Hardened Steels			Stainless Steels	Tool Steels	Cast Steels	Cast Iron	Ductile Cast Iron	Copper	Brass	Brass Casting	Bronze	Aluminum Rolled	Aluminum Alloy Casting	Magnesium Alloy Casting	Zinc Alloy Casting	Titanium Alloys	Nickel Alloys	Thermo Setting Plastic	Thermo Plastic
C -0.25%	C0.25% -0.45%	C 0.45%-	SCM	25-45 HRC	45-55 HRC	50-60 HRC	SUS	SKD	SC	FC	FCD	Cu	Bs	BsC	PB	AL	AC,ADC	MC	ZDC				
○	○	○	◎							○	○	○	○	○	○	◎	○	○	○				○

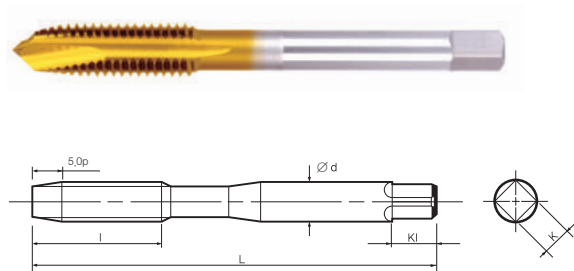

POINT TAPS

- Designed for high performance of threading Carbon steel, Alloy steel and Nonferrous metals.
- Suitable for tapping of through holes.
- By applying TiN coating, it provides stable and highly efficient operation due to enhanced durability.

VNTM...series



EDP. No. 5P	Thread Size	Limits	L	l	d	K	Kl	STOCK
VNTM0305050	M3 X 0.5	WH2	46	11	4	3.2	6	•
VNTM0407050	M4 X 0.7	WH2	52	13	5	4	7	•
VNTM0508050	M5 X 0.8	WH2	60	16	5.5	4.5	7	•
VNTM0610050	M6 X 1.0	WH2	62	19	6	4.5	7	•
VNTM0812550	M8 X 1.25	WH3	70	22	6.2	5	8	•
VNTM1012550	M10 X 1.25	WH3	75	24	7	5.5	8	•
VNTM1015050	M10 X 1.5	WH3	75	24	7	5.5	8	•
VNTM1210050	M12 X 1.0	WH3	82	29	8.5	6.5	9	•
VNTM1212550	M12 X 1.25	WH3	82	29	8.5	6.5	9	•
VNTM1215050	M12 X 1.5	WH3	82	29	8.5	6.5	9	•
VNTM1217550	M12 X 1.75	WH4	82	29	8.5	6.5	9	•
VNTM1415050	M14 X 1.5	WH3	88	30	10.5	8	11	•
VNTM1420050	M14 X 2.0	WH4	88	30	10.5	8	11	•
VNTM1615050	M16 X 1.5	WH3	95	32	12.5	10	13	•
VNTM1620050	M16 X 2.0	WH4	95	32	12.5	10	13	•
VNTM1815050	M18 X 1.5	WH4	100	37	14	11	14	•
VNTM1825050	M18 X 2.5	WH4	100	37	14	11	14	•
VNTM2015050	M20 X 1.5	WH4	105	37	15	12	15	•
VNTM2025050	M20 X 2.5	WH4	105	37	15	12	15	•

■ Work Material

Low Carbon Steels	Medium Carbon Steels	High Carbon Steels	Alloy Steels	Hardened Steels			Stainless Steels	Tool Steels	Cast Steels	Cast Iron	Ductile Cast Iron	Copper	Brass	Brass Casting	Bronze	Aluminum Rolled	Aluminum Alloy Casting	Magnesium Alloy Casting	Zinc Alloy Casting	Titanium Alloys	Nickel Alloys	Thermo Setting Plastic	Thermo Plastic
C -0.25%	C0.25% -0.45%	C 0.45%--	SCM	25-45 HRC	45-55 HRC	50-60 HRC	SUS	SKD	SC	FC	FCD	Cu	Bs	BsC	PB	AL	AC,ADC	MC	ZDC				
○	○	○	○				◎	○	○	○	○	○	○	○	○	○	○	○	○	○	○	○	○

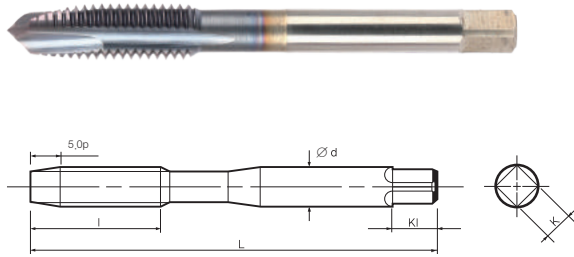

POINT TAPS

- Designed for high performance of threading Carbon steel, Alloy steel and Nonferrous metals.
- Suitable for tapping of through holes.
- By applying TiCN coating, it provides stable and highly efficient operation due to enhanced durability.

VNCM...series



EDP. No. 5P	Thread Size	Limits	L	l	d	K	Kl	STOCK
VNCM0305050	M3 X 0.5	WH2	46	11	4	3.2	6	•
VNCM0407050	M4 X 0.7	WH2	52	13	5	4	7	•
VNCM0508050	M5 X 0.8	WH2	60	16	5.5	4.5	7	•
VNCM0610050	M6 X 1.0	WH2	62	19	6	4.5	7	•
VNCM0812550	M8 X 1.25	WH2	70	22	6.2	5	8	•
VNCM1012550	M10 X 1.25	WH2	75	24	7	5.5	8	•
VNCM1015050	M10 X 1.5	WH3	75	24	7	5.5	8	•
VNCM1210050	M12 X 1.0	WH2	82	29	8.5	6.5	9	•
VNCM1212550	M12 X 1.25	WH2	82	29	8.5	6.5	9	•
VNCM1215050	M12 X 1.5	WH3	82	29	8.5	6.5	9	•
VNCM1217550	M12 X 1.75	WH3	82	29	8.5	6.5	9	•
VNCM1415050	M14 X 1.5	WH3	88	30	10.5	8	11	•
VNCM1420050	M14 X 2.0	WH3	88	30	10.5	8	11	•
VNCM1615050	M16 X 1.5	WH3	95	32	12.5	10	13	•
VNCM1620050	M16 X 2.0	WH3	95	32	12.5	10	13	•
VNCM1815050	M18 X 1.5	WH3	100	37	14	11	14	•
VNCM1825050	M18 X 2.5	WH3	100	37	14	11	14	•
VNCM2015050	M20 X 1.5	WH3	105	37	15	12	15	•
VNCM2025050	M20 X 2.5	WH3	105	37	15	12	15	•

Work Material

Low Carbon Steels	Medium Carbon Steels	High Carbon Steels	Alloy Steels	Hardened Steels			Stainless Steels	Tool Steels	Cast Steels	Cast Iron	Ductile Cast Iron	Copper	Brass	Brass Casting	Bronze	Aluminum Rolled	Aluminum Alloy Casting	Magnesium Alloy Casting	Zinc Alloy Casting	Titanium Alloys	Nickel Alloys	Thermo Setting Plastic	Thermo Plastic
C -0.25%	C0.25% -0.45%	C 0.45%-	SCM	25-45 HRC	45-55 HRC	50-60 HRC	SUS	SKD	SC	FC	FCD	Cu	Bs	BsC	PB	AL	AC,ADC	MC	ZDC				
○	○	○	○				○	○	○	○	○	○	○	○	○	○	○	○	○	○	○	○	○

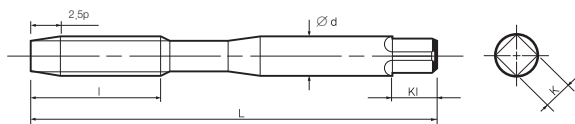

SPIRAL TAPS

- Suitable for Carbon steel, Alloy steel and Nonferrous metals and the unique shape of the groove is designed for high release of chips.
- Suitable for tapping of blind holes.

VPOM...series



EDP. No. 2.5P	Thread Size	Limits	L	l	d	K	Kl	Flutes	STOCK
VPOM0305025	M3 X 0.5	WH2	46	11	4	3.2	6	3	•
VPOM0407025	M4 X 0.7	WH2	52	13	5	4	7	3	•
VPOM0508025	M5 X 0.8	WH2	60	16	5.5	4.5	7	3	•
VPOM0610025	M6 X 1.0	WH2	62	19	6	4.5	7	3	•
VPOM0812525	M8 X 1.25	WH2	70	22	6.2	5	8	3	•
VPOM1012525	M10 X 1.25	WH2	75	24	7	5.5	8	3	•
VPOM1015025	M10 X 1.5	WH3	75	24	7	5.5	8	3	•
VPOM1210025	M12 X 1.0	WH2	82	29	8.5	6.5	9	3	•
VPOM1212525	M12 X 1.25	WH2	82	29	8.5	6.5	9	3	•
VPOM1215025	M12 X 1.5	WH3	82	29	8.5	6.5	9	3	•
VPOM1217525	M12 X 1.75	WH3	82	29	8.5	6.5	9	3	•
VPOM1415025	M14 X 1.5	WH3	88	30	10.5	8	11	3	•
VPOM1420025	M14 X 2.0	WH3	88	30	10.5	8	11	3	•
VPOM1615025	M16 X 1.5	WH3	95	32	12.5	10	13	3	•
VPOM1620025	M16 X 2.0	WH3	95	32	12.5	10	13	3	•
VPOM1815025	M18 X 1.5	WH3	100	37	14	11	14	4	•
VPOM1825025	M18 X 2.5	WH3	100	37	14	11	14	4	•
VPOM2015025	M20 X 1.5	WH3	105	37	15	12	15	4	•
VPOM2025025	M20 X 2.5	WH3	105	37	15	12	15	4	•

■ Work Material

Low Carbon Steels	Medium Carbon Steels	High Carbon Steels	Alloy Steels	Hardened Steels			Stainless Steels	Tool Steels	Cast Steels	Cast Iron	Ductile Cast Iron	Copper	Brass	Brass Casting	Bronze	Aluminum Rolled	Aluminum Alloy Casting	Magnesium Alloy Casting	Zinc Alloy Casting	Titanium Alloys	Nickel Alloys	Thermo Setting Plastic	Thermo Plastic
C -0.25%	C0.25% -0.45%	C 0.45%-	SCM	25-45 HRC	45-55 HRC	50-60 HRC	SUS	SKD	SC	FC	FCD	Cu	Bs	BsC	PB	AL	AC,ADC	MC	ZDC				
○			◎								○	○	○	○	○	○	○	○	○				○

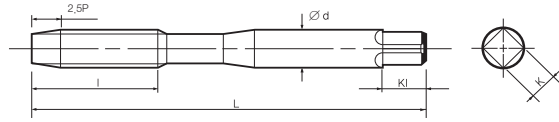

SPIRAL TAPS

- Suitable for Carbon steel, Alloy steel and Nonferrous metals and the unique shape of the groove is designed for high release of chips.
- Suitable for tapping of blind holes.
- By applying TiN coating, it provides stable and highly efficient operation due to enhanced durability.

VPTM...series



EDP. No. 2.5P	Thread Size	Limits	L	l	d	K	KI	Flutes	STOCK
VPTM0305025	M3 X 0.5	WH2	46	11	4	3.2	6	3	•
VPTM0407025	M4 X 0.7	WH2	52	13	5	4	7	3	•
VPTM0508025	M5 X 0.8	WH2	60	16	5.5	4.5	7	3	•
VPTM0610025	M6 X 1.0	WH2	62	19	6	4.5	7	3	•
VPTM0812525	M8 X 1.25	WH2	70	22	6.2	5	8	3	•
VPTM1012525	M10 X 1.25	WH2	75	24	7	5.5	8	3	•
VPTM1015025	M10 X 1.5	WH2	75	24	7	5.5	8	3	•
VPTM1210025	M12 X 1.0	WH2	82	29	8.5	6.5	9	3	•
VPTM1212525	M12 X 1.25	WH2	82	29	8.5	6.5	9	3	•
VPTM1215025	M12 X 1.5	WH2	82	29	8.5	6.5	9	3	•
VPTM1217525	M12 X 1.75	WH2	82	29	8.5	6.5	9	3	•
VPTM1415025	M14 X 1.5	WH2	88	30	10.5	8	11	3	•
VPTM1420025	M14 X 2.0	WH2	88	30	10.5	8	11	3	•
VPTM1615025	M16 X 1.5	WH2	95	32	12.5	10	13	3	•
VPTM1620025	M16 X 2.0	WH2	95	32	12.5	10	13	3	•
VPTM1815025	M18 X 1.5	WH2	100	37	14	11	14	4	•
VPTM1825025	M18 X 2.5	WH3	100	37	14	11	14	4	•
VPTM2015025	M20 X 1.5	WH3	105	37	15	12	15	4	•
VPTM2025025	M20 X 2.5	WH3	105	37	15	12	15	4	•

Work Material

Low Carbon Steels	Medium Carbon Steels	High Carbon Steels	Alloy Steels	Hardened Steels			Stainless Steels	Tool Steels	Cast Steels	Cast Iron	Ductile Cast Iron	Copper	Brass	Brass Casting	Bronze	Aluminum Rolled	Aluminum Alloy Casting	Magnesium Alloy Casting	Zinc Alloy Casting	Titanium Alloys	Nickel Alloys	Thermo Setting Plastic	Thermo Plastic
C -0.25%	C0.25% -0.45%	C 0.45%-	SCM	25-45 HRC	45-55 HRC	50-60 HRC	SUS	SKD	SC	FC	FCD	Cu	Bs	BsC	PB	AL	AC,ADC	MC	ZDC				
○	○	○	○				○	○	○		○	○	○	○	○	○	○	○	○	○			○

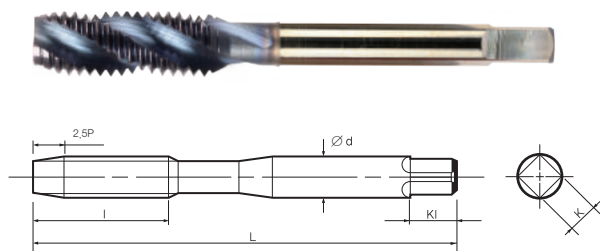

SPIRAL TAPS

- Suitable for Carbon steel, Alloy steel and Nonferrous metals and the unique shape of the groove is designed for high release of chips.
- Suitable for tapping of blind holes.
- By applying TiCN coating, it provides stable and highly efficient operation due to enhanced durability.

VPCM...series



EDP. No. 2.5P	Thread Size	Limits	L	l	d	K	Kl	Flutes	STOCK
VPCM0305025	M3 X 0.5	WH2	46	11	4	3.2	6	3	•
VPCM0407025	M4 X 0.7	WH2	52	13	5	4	7	3	•
VPCM0508025	M5 X 0.8	WH2	60	16	5.5	4.5	7	3	•
VPCM0610025	M6 X 1.0	WH2	62	19	6	4.5	7	3	•
VPCM0812525	M8 X 1.25	WH2	70	22	6.2	5	8	3	•
VPCM1012525	M10 X 1.25	WH2	75	24	7	5.5	8	3	•
VPCM1015025	M10 X 1.5	WH3	75	24	7	5.5	8	3	•
VPCM1210025	M12 X 1.0	WH2	82	29	8.5	6.5	9	3	•
VPCM1212525	M12 X 1.25	WH2	82	29	8.5	6.5	9	3	•
VPCM1215025	M12 X 1.5	WH3	82	29	8.5	6.5	9	3	•
VPCM1217525	M12 X 1.75	WH3	82	29	8.5	6.5	9	3	•
VPCM1415025	M14 X 1.5	WH3	88	30	10.5	8	11	3	•
VPCM1420025	M14 X 2.0	WH3	88	30	10.5	8	11	3	•
VPCM1615025	M16 X 1.5	WH3	95	32	12.5	10	13	3	•
VPCM1620025	M16 X 2.0	WH3	95	32	12.5	10	13	3	•
VPCM1815025	M18 X 1.5	WH3	100	37	14	11	14	4	•
VPCM1825025	M18 X 2.5	WH3	100	37	14	11	14	4	•
VPCM2015025	M20 X 1.5	WH3	105	37	15	12	15	4	•
VPCM2025025	M20 X 2.5	WH3	105	37	15	12	15	4	•

■ Work Material

Low Carbon Steels	Medium Carbon Steels	High Carbon Steels	Alloy Steels	Hardened Steels			Stainless Steels	Tool Steels	Cast Steels	Cast Iron	Ductile Cast Iron	Copper	Brass	Brass Casting	Bronze	Aluminum Rolled	Aluminum Alloy Casting	Magnesium Alloy Casting	Zinc Alloy Casting	Titanium Alloys	Nickel Alloys	Thermo Setting Plastic	Thermo Plastic
C -0.25%	C0.25% -0.45%	C 0.45%-	SCM	25-45 HRC	45-55 HRC	50-60 HRC	SUS	SKD	SC	FC	FCD	Cu	Bs	BsC	PB	AL	AC,ADC	MC	ZDC				
○	◎	◎	○				○	○	○		○	○	○	○	○	○	◎	○	○	○	○		○

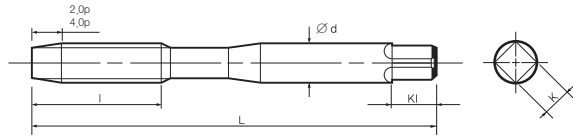

ROLL TAPS

- Designed for high performance of threading
Aluminum, Zinc, Copper and other Nonferrous alloys.

VROM...series



EDP. No.		Thread Size	Limits	L	l	d	K	KI	Oil Groove	STOCK
2P	4P									
VROM0305020S	VROM0305040S	M3 X 0.5	GH5	46	11	4	3.2	6	1	•
VROM0305020M	VROM0305040M								4	•
VROM0407020S	VROM0407040S	M4 X 0.7	GH6	52	13	5	4	7	1	•
VROM0407020M	VROM0407040M								4	•
VROM0508020S	VROM0508040S	M5 X 0.8	GH6	60	16	5.5	4.5	7	1	•
VROM0508020M	VROM0508040M								4	•
VROM0610020S	VROM0610040S	M6 X 1.0	GH7	62	19	6	4.5	7	1	•
VROM0610020M	VROM0610040M								4	•
VROM0812520S	VROM0812540S	M8 X 1.25	GH7	70	22	6.2	5	8	1	•
VROM0812520M	VROM0812540M								4	•
VROM1012520S	VROM1012540S	M10 X 1.25	GH7	75	24	7	5.5	8	1	•
VROM1012520M	VROM1012540M								4	•
VROM1015020S	VROM1015040S	M10 X 1.50	GH7	75	24	7	5.5	8	1	•
VROM1015020M	VROM1015040M								4	•
VROM1210020S	VROM1210040S	M12 X 1.0	GH7	82	29	8.5	6.5	9	1	•
VROM1210020M	VROM1210040M								4	•
VROM1212520S	VROM1212540S	M12 X 1.25	GH7	82	29	8.5	6.5	9	1	•
VROM1212520M	VROM1212540M								4	•
VROM1215020S	VROM1215040S	M12 X 1.5	GH7	82	29	8.5	6.5	9	1	•
VROM1215020M	VROM1215040M								4	•
VROM1217520S	VROM1217540S	M12 X 1.75	GH8	82	29	8.5	6.5	9	1	•
VROM1217520M	VROM1217540M								4	•

Work Material

Low Carbon Steels	Medium Carbon Steels	High Carbon Steels	Alloy Steels	Hardened Steels			Stainless Steels	Tool Steels	Cast Steels	Cast Iron	Ductile Cast Iron	Copper	Brass	Brass Casting	Bronze	Aluminum Rolled	Aluminum Alloy Casting	Magnesium Alloy Casting	Zinc Alloy Casting	Titanium Alloys	Nickel Alloys	Thermo Setting Plastic	Thermo Plastic
C -0.25%	C0.25% -0.45%	C 0.45%-	SCM	25-45 HRC	45-55 HRC	50-60 HRC	SUS	SKD	SC	FC	FCD	Cu	Bs	BsC	PB	AL	AC,ADC	MC	ZDC				
												○	○	○	○	○	○		◎				

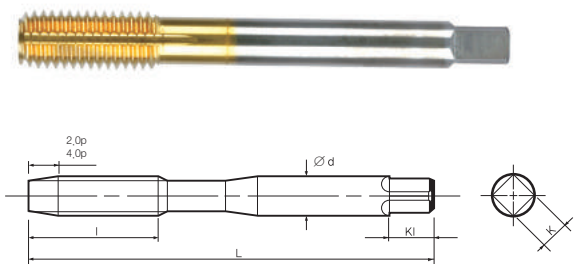

ROLL TAPS

- It is applicable regardless of steel or Nonferrous alloys.
- By applying TiN coating, it provides stable and highly efficient operation due to enhanced durability.

VRTM...series



EDP. No.		Thread Size	Limits	L	l	d	K	KI	Oil Groove	STOCK
2P	4P									
VRTM0305020S	VRTM0305040S	M3 X 0.5	GH5	46	11	4	3.2	6	1	•
VRTM0305020M	VRTM0305040M								4	•
VRTM0407020S	VRTM0407040S	M4 X 0.7	GH6	52	13	5	4	7	1	•
VRTM0407020M	VRTM0407040M								4	•
VRTM0508020S	VRTM0508040S	M5 X 0.8	GH6	60	16	5.5	4.5	7	1	•
VRTM0508020M	VRTM0508040M								4	•
VRTM0610020S	VRTM0610040S	M6 X 1.0	GH7	62	19	6	4.5	7	1	•
VRTM0610020M	VRTM0610040M								4	•
VRTM0812520S	VRTM0812540S	M8 X 1.25	GH7	70	22	6.2	5	8	1	•
VRTM0812520M	VRTM0812540M								4	•
VRTM1012520S	VRTM1012540S	M10 X 1.25	GH7	75	24	7	5.5	8	1	•
VRTM1012520M	VRTM1012540M								4	•
VRTM1015020S	VRTM1015040S	M10 X 1.50	GH7	75	24	7	5.5	8	1	•
VRTM1015020M	VRTM1015040M								4	•
VRTM1210020S	VRTM1210040S	M12 X 1.0	GH7	82	29	8.5	6.5	9	1	•
VRTM1210020M	VRTM1210040M								4	•
VRTM1212520S	VRTM1212540S	M12 X 1.25	GH7	82	29	8.5	6.5	9	1	•
VRTM1212520M	VRTM1212540M								4	•
VRTM1215020S	VRTM1215040S	M12 X 1.5	GH7	82	29	8.5	6.5	9	1	•
VRTM1215020M	VRTM1215040M								4	•
VRTM1217520S	VRTM1217540S	M12 X 1.75	GH8	82	29	8.5	6.5	9	1	•
VRTM1217520M	VRTM1217540M								4	•

Work Material

Low Carbon Steels	Medium Carbon Steels	High Carbon Steels	Alloy Steels	Hardened Steels			Stainless Steels	Tool Steels	Cast Steels	Cast Iron	Ductile Cast Iron	Copper	Brass	Brass Casting	Bronze	Aluminum Rolled	Aluminum Alloy Casting	Magnesium Alloy Casting	Zinc Alloy Casting	Titanium Alloys	Nickel Alloys	Thermo Setting Plastic	Thermo Plastic
C	C	C	SCM	25-45 HRC	45-55 HRC	50-60 HRC	SUS	SKD	SC	FC	FCD	Cu	Bs	BsC	PB	AL	AC,ADC	MC	ZDC				
-0.25%	0.25% -0.45%	0.45% -					◎	○	○		○	○	○	○									
○	○	○	○																				

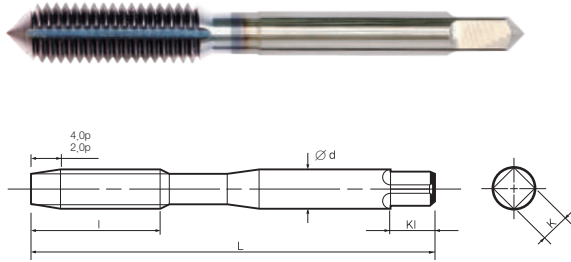

ROLL TAPS

- It is applicable regardless of steel or Nonferrous alloys.
- By applying TiCN coating, it provides stable and highly efficient operation due to enhanced durability.

VRCM...series



EDP. No.		Thread Size	Limits	L	l	d	K	KI	Oil Groove	STOCK
2P	4P									
VRCM0305020S	VRCM0305040S	M3 X 0.5	GH5	46	11	4	3.2	6	1	•
VRCM0305020M	VRCM0305040M								4	•
VRCM0407020S	VRCM0407040S	M4 X 0.7	GH6	52	13	5	4	7	1	•
VRCM0407020M	VRCM0407040M								4	•
VRCM0508020S	VRCM0508040S	M5 X 0.8	GH6	60	16	5.5	4.5	7	1	•
VRCM0508020M	VRCM0508040M								4	•
VRCM0610020S	VRCM0610040S	M6 X 1.0	GH7	62	19	6	4.5	7	1	•
VRCM0610020M	VRCM0610040M								4	•
VRCM0812520S	VRCM0812540S	M8 X 1.25	GH7	70	22	6.2	5	8	1	•
VRCM0812520M	VRCM0812540M								4	•
VRCM1012520S	VRCM1012540S	M10 X 1.25	GH7	75	24	7	5.5	8	1	•
VRCM1012520M	VRCM1012540M								4	•
VRCM1015020S	VRCM1015040S	M10 X 1.50	GH7	75	24	7	5.5	8	1	•
VRCM1015020M	VRCM1015040M								4	•
VRCM1210020S	VRCM1210040S	M12 X 1.0	GH7	82	29	8.5	6.5	9	1	•
VRCM1210020M	VRCM1210040M								4	•
VRCM1212520S	VRCM1212540S	M12 X 1.25	GH7	82	29	8.5	6.5	9	1	•
VRCM1212520M	VRCM1212540M								4	•
VRCM1215020S	VRCM1215040S	M12 X 1.5	GH7	82	29	8.5	6.5	9	1	•
VRCM1215020M	VRCM1215040M								4	•
VRCM1217520S	VRCM1217540S	M12 X 1.75	GH8	82	29	8.5	6.5	9	1	•
VRCM1217520M	VRCM1217540M								4	•

Work Material

Low Carbon Steels	Medium Carbon Steels	High Carbon Steels	Alloy Steels	Hardened Steels			Stainless Steels	Tool Steels	Cast Steels	Cast Iron	Ductile Cast Iron	Copper	Brass	Brass Casting	Bronze	Aluminum Rolled	Aluminum Alloy Casting	Magnesium Alloy Casting	Zinc Alloy Casting	Titanium Alloys	Nickel Alloys	Thermo Setting Plastic	Thermo Plastic
C	C	C	SCM	25-45 HRC	45-55 HRC	50-60 HRC	SUS	SKD	SC	FC	FCD	Cu	Bs	BsC	PB	AL	AC,ADC	MC	ZDC				
-0.25%	0.25% -0.45%	0.45% -					◎					◎	◎	◎		◎	◎		◎				

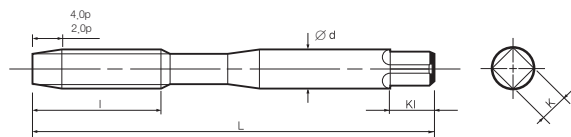

SPIRAL ROLL TAPS

- Designed for high performance of threading
Aluminum, Zinc, Magnesium, Copper and other
Nonferrous alloys.

VFOM...series



EDP. No.		Thread Size	Limits	L	l	d	K	Kl	STOCK
2P	4P								
VFOM0305020	VFOM0305040	M3 X 0.5	GH6	46	18	4	3.2	6	•
VFOM03506020	VFOM03506040	M3.5 X 0.6	GH6	46	18	4	3.2	6	•
VFOM0407020	VFOM0407040	M4 X 0.7	GH7	52	20	5	4	7	•
VFOM0508020	VFOM0508040	M5 X 0.8	GH7	60	22	5.5	4.5	7	•
VFOM0610020	VFOM0610040	M6 X 1.0	GH7	62	24	6	4.5	7	•

■ Work Material

Low Carbon Steels	Medium Carbon Steels	High Carbon Steels	Alloy Steels	Hardened Steels			Stainless Steels	Tool Steels	Cast Steels	Cast Iron	Ductile Cast Iron	Copper	Brass	Brass Casting	Bronze	Aluminum Rolled	Aluminum Alloy Casting	Magnesium Alloy Casting	Zinc Alloy Casting	Titanium Alloys	Nickel Alloys	Thermo Setting Plastic	Thermo Plastic
C	C	C	SCM	25-45 HRC	45-55 HRC	50-60 HRC	SUS	SKD	SC	FC	FCD	Cu	Bs	BsC	PB	AL	AC,ADC	MC	ZDC				
-0.25%	0.25% -0.45%	0.45% -										○	○	○	○	○	○		◎				

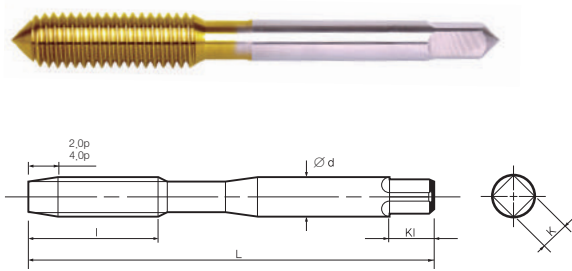

SPIRAL ROLL TAPS

- Designed for high performance of threading Nonferrous alloys, Steel, and Stainless steel.
- By applying TiN coating, it provides stable and highly efficient operation due to enhanced durability.

VFTM...series



EDP. No.		Thread Size	Limits	L	l	d	K	Kl	STOCK
2P	4P								
VFTM0305020	VFTM0305040	M3 X 0.5	GH6	46	18	4	3.2	6	•
VFTM03506020	VFTM03506040	M3.5 X 0.6	GH6	46	18	4	3.2	6	•
VFTM0407020	VFTM0407040	M4 X 0.7	GH7	52	20	5	4	7	•
VFTM0508020	VFTM0508040	M5 X 0.8	GH7	60	22	5.5	4.5	7	•
VFTM0610020	VFTM0610040	M6 X 1.0	GH7	62	24	6	4.5	7	•

Work Material

Low Carbon Steels	Medium Carbon Steels	High Carbon Steels	Alloy Steels	Hardened Steels			Stainless Steels	Tool Steels	Cast Steels	Cast Iron	Ductile Cast Iron	Copper	Brass	Brass Casting	Bronze	Aluminum Rolled	Aluminum Alloy Casting	Magnesium Alloy Casting	Zinc Alloy Casting	Titanium Alloys	Nickel Alloys	Thermo Setting Plastic	Thermo Plastic	
C -0.25%	C0.25% -0.45%	C 0.45%-	SCM	25-45 HRC	45-55 HRC	50-60 HRC	SUS	SKD	SC	FC	FCD	Cu	Bs	BsC	PB	AL	AC,ADC	MC	ZDC					
○	○	○	○				◎	○	○		○	○	○	○										

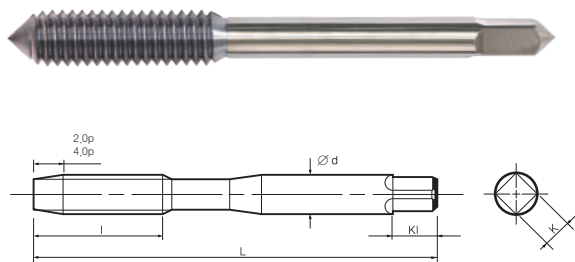

SPIRAL ROLL TAPS

- Designed for high performance of threading Nonferrous alloys, Steel, and Stainless steel.
- By applying TiCN coating, it provides stable and highly efficient operation due to enhanced durability.

VFCM...series



EDP. No.		Thread Size	Limits	L	l	d	K	Kl	STOCK
2P	4P								
VFCM0305020	VFCM0305040	M3 X 0.5	GH6	46	18	4	3.2	6	•
VFCM03506020	VFCM03506040	M3.5 X 0.6	GH6	46	18	4	3.2	6	•
VFCM0407020	VFCM0407040	M4 X 0.7	GH7	52	20	5	4	7	•
VFCM0508020	VFCM0508040	M5 X 0.8	GH7	60	22	5.5	4.5	7	•
VFCM0610020	VFCM0610040	M6 X 1.0	GH7	62	24	6	4.5	7	•

Work Material

Low Carbon Steels	Medium Carbon Steels	High Carbon Steels	Alloy Steels	Hardened Steels			Stainless Steels	Tool Steels	Cast Steels	Cast Iron	Ductile Cast Iron	Copper	Brass	Brass Casting	Bronze	Aluminum Rolled	Aluminum Alloy Casting	Magnesium Alloy Casting	Zinc Alloy Casting	Titanium Alloys	Nickel Alloys	Thermo Setting Plastic	Thermo Plastic
C -0,25%	C0,25% -0,45%	C 0,45%-	SCM	25-45 HRC	45-55 HRC	50-60 HRC	SUS	SKD	SC	FC	FCD	Cu	Bs	BsC	PB	AL	AC,ADC	MC	ZDC				
○	○	○	○				○					○	○	○		○	○		○				

WH Limits

WH Limits

WIDIN applies a unique WH limits system in order to fulfill the degree of an internal screw and provides users the best tools for suitable working and operating conditions.

1. $\{p \leq 0.6(T.P.I \geq 40)\}$

Upper Limits : $0.010 + 0.015 \times n$

Lower Limits : Upper Limits - 0.015

Unit :mm (n=WH)

2. $\{p \leq 0.7(T.P.I \leq 36)\}$

Upper Limits : $0.020 \times n$

Lower Limits : Upper Limits - 0.020

Unit:mm (n=WH)

Example M3×0.5

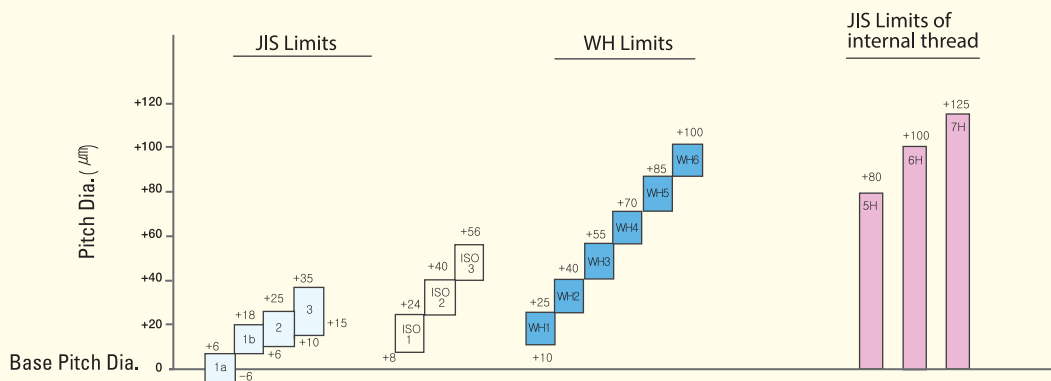

Example M10×1.5

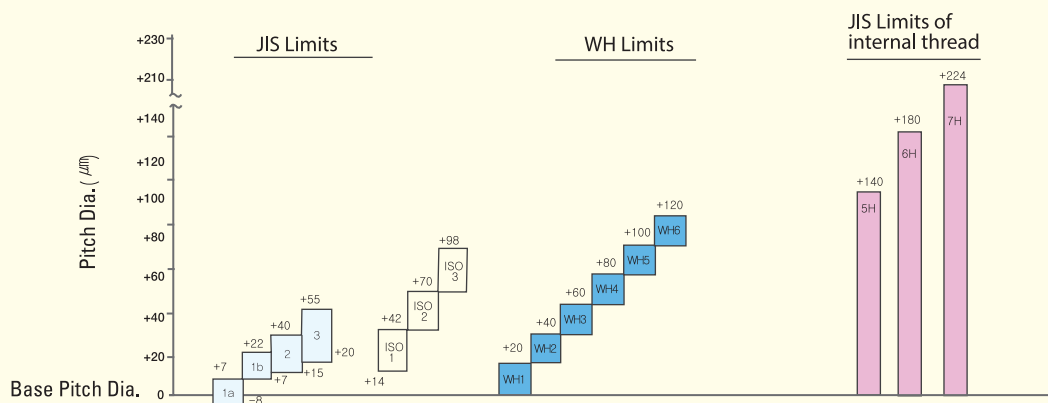

GH Limits

GH Limits

WIDIN applies the strict tap pitch diameter limits because Fluteless taps need to be managed by the rigid diameter of a bottom hole (unlike other normal taps) for it to be able to make precise tapping process of an internal screw by Plastic working.

WIDIN adopts the limits tolerance of $12.7\mu\text{m}$ (0.0005) increments.

Example M3x0.5

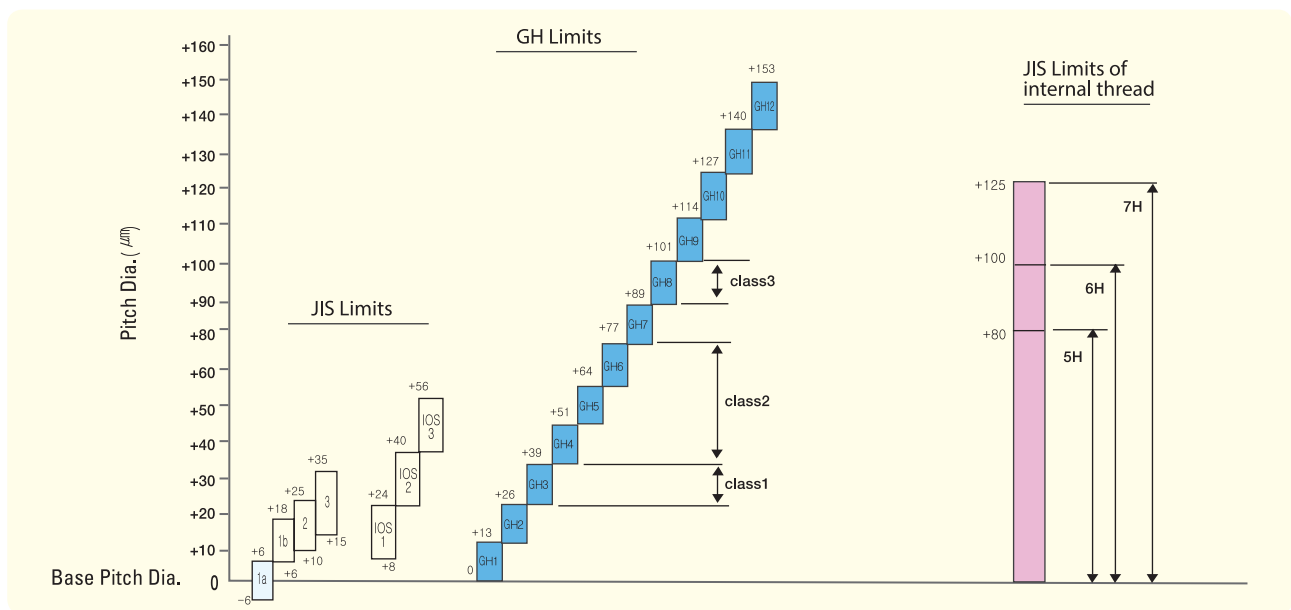

Example M10x1.5

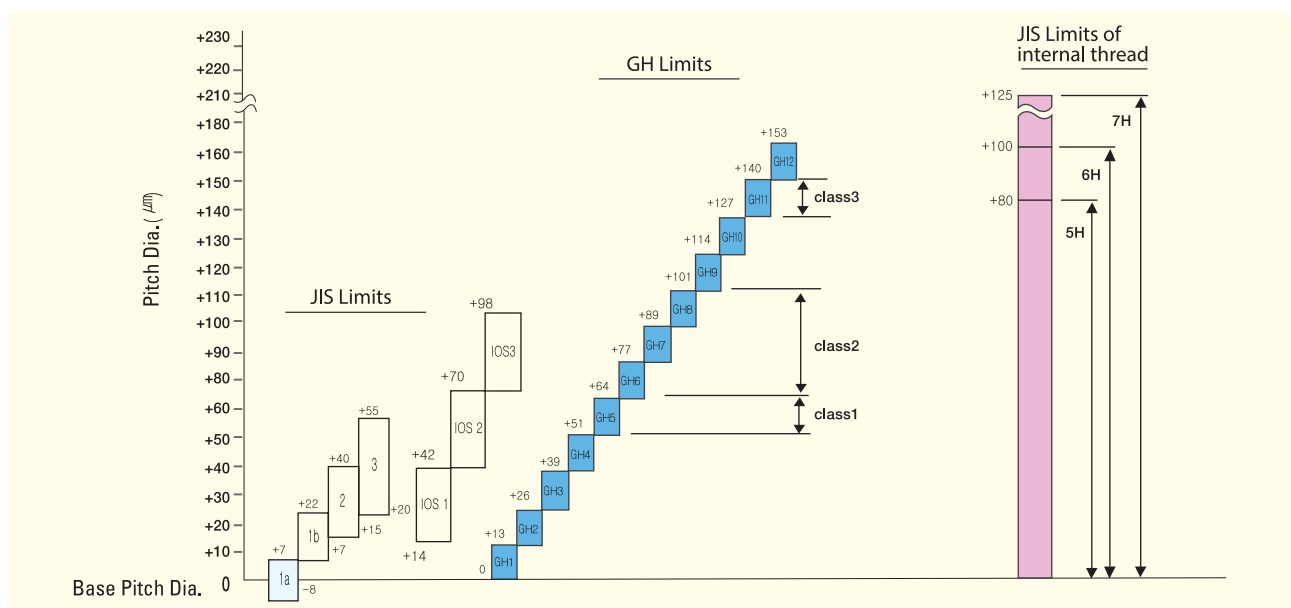

Recommended tapping speeds and lubricants

Tapping speeds depend on very important factors such as material and type of tap, chamfer length, dimension of holes, work materials and fluids.

Users need to check every aspect before applying it.

Moreover, lubricant, cooling and abrasion resistance are three important factors affecting cutting fluids.

Therefore, users should provide enough fluids during the tapping process.

Recommended tapping speeds and lubricants

Work Material		Speed(m/min)							Lubricants			
		Straight Fluted Tap	Spiral Fluted Tap	Spiral Pointed Tap	Tungsten Carbide Tap	Fluteless Tap	HighSpeed Synchro Tap	Pipe Thread Tap	Non Water-soluble	Water-soluble	Semi-dry	Dry
Low Carbon Steels	C ~0.25%	8~13	8~13	15~25	-	8~13	27~32	3~6	◎	○	△	△
Medium Carbon Steels	C0.25% ~0.45%	7~12	7~12	10~15	-	7~10	27~32	3~6	◎	○	△	△
High Carbon Steels	C 0.45%~	6~9	6~9	8~13	-	5~8	22~27	2~5	◎	○	△	△
Alloy Steels	SCM	7~12	7~12	10~15	-	5~8	22~27	2~5	◎	△	△	△
Hardened Steels	25~45 HRC	3~5 (4~8)	3~5 (4~8)	4~6 (6~10)	-	-	15~20	2~5	◎	△	-	-
Stainless Steels	SUS	4~7	5~8	8~13	-	5~10	-	3~6	◎	○	-	-
Precipitation Hardened Steels	SUS630 SUS631	3~5	3~5	4~6	-	-	-	2~5	◎	-	-	-
Tool Steels	SKD	6~9	6~9	7~10	-	-	-	2~5	◎	-	-	-
Cast Steels	SC	6~11	6~11	10~15	-	-	17~22	2~5	◎	○	-	-
Cast Iron	FC	10~15	-	-	10~20	-	-	2~5	◎	○	○	○
Ductile Cast Iron	FCD	7~12	7~12	10~20	10~20	-	-	4~8	◎	○	○	-
Copper	Cu	6~9	6~11	7~12	10~20	7~12	27~32	2~5	○	○	-	-
Brass, Brass Casting	Bs, Bsc	10~15	10~20	15~25	15~25	7~12	27~32	5~10	○	○	○	○
Bronze, Bronze Casting	PB, PBC	6~11	6~11	10~20	10~20	7~12	-	6~11	○	○	-	-
Aluminum Rolled	AL	10~20	10~20	15~25	-	10~20	100~300	5~10	◎	○	△	-
Aluminum Alloy Casting	AC, ADC	10~15	10~15	15~20	10~20	10~25	80~300	10~15	◎	○	△	-
Magnesium Alloy Casting	MC	7~12	7~12	10~15	10~20	-	-	10~15	◎	○	○	-
Zinc Alloy Casting	ZDC	1~12	7~12	10~15	10~20	7~12	27~100	10~15	◎	○	△	-
Thermo Setting Plastic	Bakelite, Phenol Epoxy	10~20	-	-	15~25	-	-	5~10	-	○	○	○
Thermo Plastic	Vinyl Chloride Nylon	10~20	10~15	10~20	10~20	-	27~32	5~10	-	○	○	○

◎: Ideal / ○: Good / △: Applicable / -: Not Applicable

Drill hole Size for Metric Screw Threads in Accordance with 2nd Class of Limits

□ Straight Tap, Spiral tap

Thread Size	Drill Size(mm)	mm	
		Min	Max
M3 X 0.5	2.50	2.459	2.599
M4 X 0.7	3.30	3.242	3.422
M5 X 0.8	4.20	4.134	4.334
M6 X 1.0	5.00	4.917	5.153
M8 X 1.25	6.80	6.647	6.912
M10 X 1.25	8.80	8.647	8.912
M10 X 1.5	8.50	8.376	8.676
M12 X 1.0	11.00	10.917	11.153
M12 X 1.25	10.80	10.647	10.912
M12 X 1.5	10.50	10.376	10.676
M12 X 1.75	10.30	10.106	10.441
M14 X 1.5	12.50	12.376	12.676
M14 X 2.0	12.00	11.835	12.21
M16 X 1.5	14.50	14.376	14.676
M16 X 2.0	14.00	13.835	14.21
M18 X 1.5	16.50	16.376	16.676
M18 X 2.5	15.50	15.294	15.744
M20 X 1.5	18.50	18.376	18.676
M20 X 2.5	17.50	17.294	17.744

□ Roll tap

Thread Size	Drill Size(mm)	mm	
		Min	Max
M3 X 0.5	2.80	2.76	2.81
M4 X 0.7	3.70	3.65	3.7
M5 X 0.8	4.60	4.59	4.66
M6 X 1.0	5.50	5.48	5.57
M8 X 1.25	7.40	7.34	7.41
M10 X 1.25	9.40	9.34	9.41
M10 X 1.5	9.20	9.18	9.28
M12 X 1.0	11.50	11.48	11.57
M12 X 1.25	11.40	11.34	11.41
M12 X 1.5	11.20	11.18	11.28
M12 X 1.75	11.10	11.05	11.15

Hardness Conversion Table

Rm[N/mm ²]	HV 10	HB	HRc	Rm[N/mm ²]	HV 10	HB	HRc
240	75	71		920	287	273	28
255	80	76		940	293	278	29
270	85	81		970	302	287	30
285	90	86		995	310	295	31
305	95	90		1020	317	301	32
320	100	95		1050	327	311	33
335	105	100		1080	336	319	34
350	110	105		1110	345	328	35
370	115	109		1140	355	337	36
385	120	114		1170	364	346	37
400	125	119		1200	373	354	38
415	130	124		1230	382	363	39
430	135	128		1260	392	372	40
450	140	133		1300	403	383	41
465	145	138		1330	413	393	42
480	150	143		1360	423	402	43
495	155	147		1400	434	413	44
510	160	152		1440	446	424	45
530	165	157		1480	458	435	46
545	170	162		1530	473	449	47
560	175	166		1570	484	460	48
575	180	171		1620	497	472	49
595	185	176		1680	514	488	50
610	190	181		1730	527	501	51
625	195	185		1790	544	517	52
640	200	190		1845	560	532	53
660	205	195		1910	578	549	54
675	210	199		1980	596	567	55
690	215	204		2050	615	584	56
705	220	209		2140	639	607	57
720	225	214			655	622	58
740	230	219			675		59
755	135	223			698		60
770	140	228			720		61
785	145	233			745		62
800	150	238	22		773		63
820	155	242	23		800		64
835	160	247	24		829		65
860	268	255	25		864		66
870	272	258	26		900		67
900	280	266	27		940		68

Best Tools, Best Choice For Your Vision

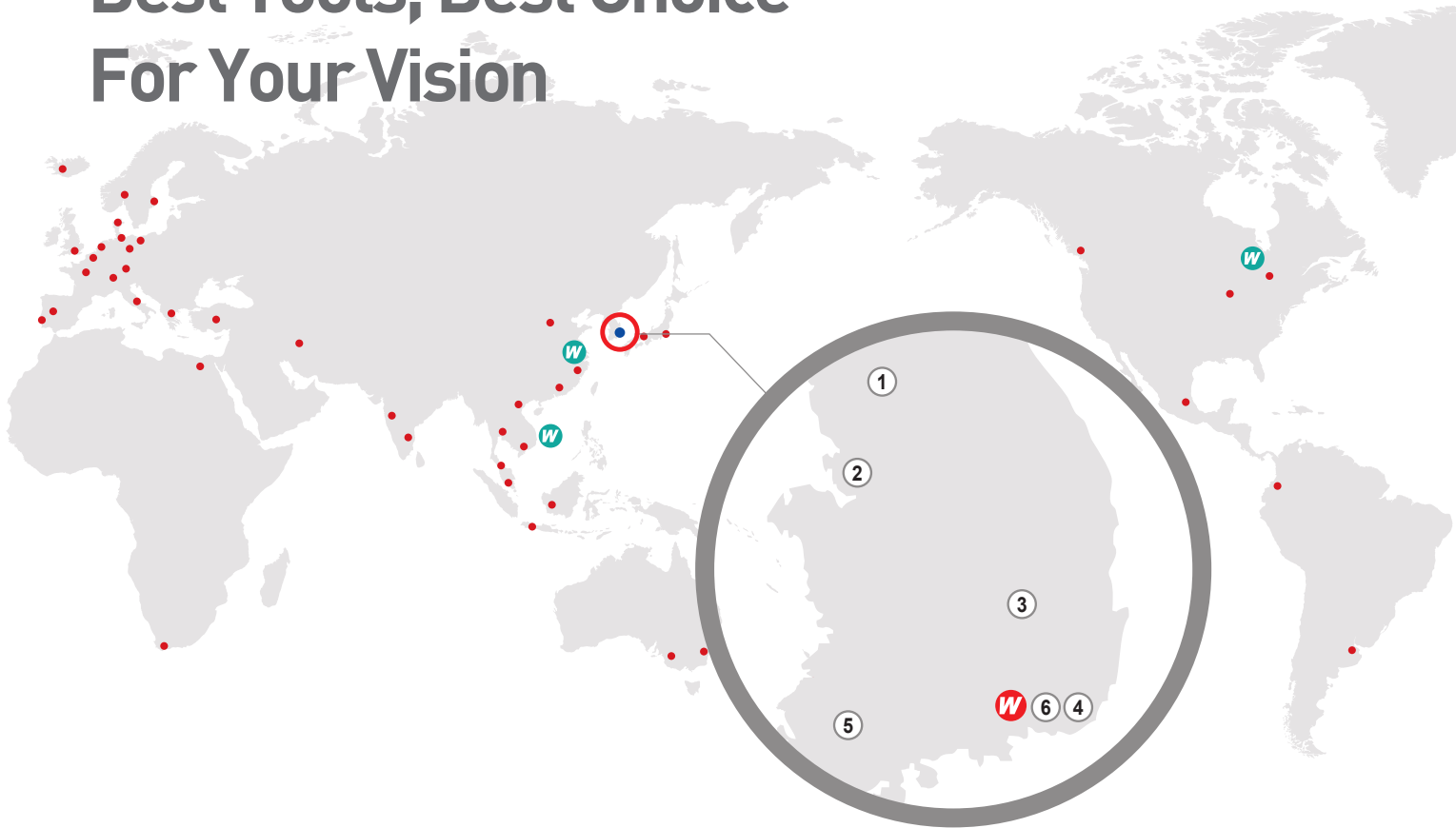

WIDIN's Local Business Sites

- Argentina
- Australia
- Austria
- Belgium
- Brazil
- Canada
- China
- Colombia
- Czech
- Denmark
- Egypt
- France
- Germany
- Greece
- Hong Kong
- Hungary
- India
- Indonesia
- Iran
- Italy
- Japan
- Malaysia
- Mexico
- Netherlands
- New Zealand
- Norway
- Philippines
- Poland
- Portugal
- Russia
- Singapore
- Slovenia
- South Africa
- Spain
- Sweden
- Switzerland
- Thailand
- Turkey
- U.S.A
- United Kingdom
- Vietnam

 Head Office(Changwon Factory)	TEL. 82-55-286-0905	FAX. 82-55-286-0978
 Chicago Office	TEL. 1-847-947-8320	FAX. 1-847-947-8322
 Shanghai Office	TEL. 86-21-5831-8103	FAX. 86-2-5831-8153
 Vietnam Office	TEL. 84-4-6287-3839	FAX. 84-4-6287-3828
1 Seoul Office	TEL. 82-02-2679-0980	FAX. 82-02-2679-0970
2 Shihwa Office	TEL. 82-31-430-5446	FAX. 82-31-430-5579
3 Daegu Office	TEL. 82-53-604-0968	FAX. 82-53-604-0932
4 Busan Office	TEL. 82-51-319-0914	FAX. 82-51-319-0976
5 Gwangju Office	TEL. 82-62-961-0985	FAX. 82-62-961-0982
6 Changwon Office	TEL. 82-55-277-9911	FAX. 82-55-237-0904



Head office & Changwon Factory

172, Sahwa-ro, Uichang-gu, Changwon-si, Gyeongsangnam-do, Korea [51389]

Chicago Office(WIDIN, INC.)

1801 Hicks Rd, Unit B Rolling Meadow il 60008

Shanghai Office(WIDIN Shanghai Trade Co.,Ltd.)

#303, NO 6818-10, Zhong Chun RD Min Hang District, Shanghai, China 201101

Vietnam Office(WIDIN VINA Co.,Ltd.)

Room A308, 3rd floor, The Manor Tower, Me Tri Rd, My Dinh Ward, Nam Tu Liem Dist, Hanoi City, Vietnam